

REVISED WITH 16 PAGES  
OF NEW PRODUCTS!

# Marine Canvas & Awning Fabrics & Hardware Catalog

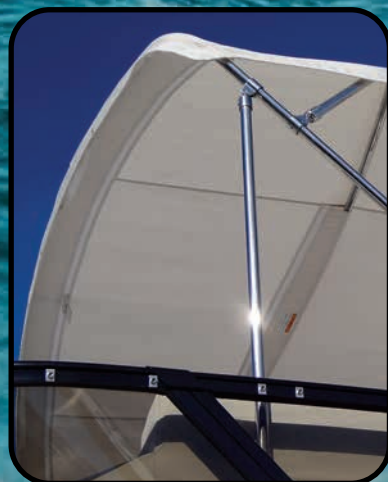

Marine Canvas & Awning

THE HOME & BAINBRIDGE

Technical Innovation and Service -  
The Fabric of Our Business

## Welcome to Our New Catalog

Welcome to Bainbridge International's revised catalog, your guide to the world's leading range of sailcloth, marine cover, awning and industrial fabrics, hardware and accessories. Over 3000 products are listed ranging from the very latest in high technology fabrics down to the simple snap fasteners.

The success of Bainbridge International is based on our commitment to supplying technically innovative solutions for specialist markets using our extensive knowledge of textiles, associated accessories and hardware.

We supply a diverse range of products to many industries through our three sales locations in Massachusetts, California and Florida in the USA. Our trained and experienced sales staff service customers in over 80 different countries and are backed by well stocked warehouse facilities able to promptly and efficiently meet our customers needs.

This latest catalog includes more new products than ever before and the first few pages highlight just a small selection of the very latest additions to our range. This demonstrates our commitment to providing quality and innovation to the many markets we serve. Our attention to product, combined with our world class service is what has made Bainbridge International a market leading organization since its inception in 1917.

On behalf of the entire team here at Bainbridge International, I would like to thank you for the opportunity to serve you and for your continued support.

Michael C. Cuscia Jr.  
Owner & Chief Executive Officer

## Weathermax 80



A patented outdoor performance fabric developed for demanding applications and environments. Super high strength and durability combine with long-term color retention to deliver a truly versatile outdoor fabric for a variety of applications.

The most balanced and cost-effective fabric available for marine covers and tops, awnings, or other outdoor applications requiring outstanding durability, higher water repellence and excellent breathability.

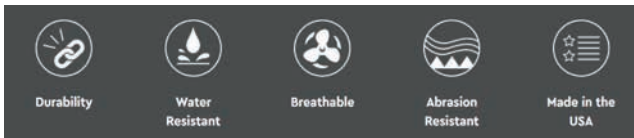

Part No.	Color	Width: mm/in		Av Roll Length: m/yd	
FH080BEIGE	Beige	1520	60	68.5	75
FH080BLK	Black	1520	60	68.5	75
FH080BURG	Burgundy	1520	60	68.5	75
FH080CNV	Captain Navy	1520	60	68.5	75
FH080FGR	Forest Green	1520	60	68.5	75
FH080GRAPH	Graphite	1520	60	68.5	75
FH080LCHR	Lite Charcoal	1520	60	68.5	75
FH080MIST	Mist	1520	60	68.5	75
FH080MOSS	Moss	1520	60	68.5	75
FH080OYS	Oyster	1520	60	68.5	75
FH080PBU	Pacific Blue	1520	60	68.5	75
FH080ROY	Royal Blue	1520	60	68.5	75
FH080SAND	Sand	1520	60	68.5	75
FH080SANH	Sandstone Heather	1520	60	68.5	75
FH080SAPTW	Sapphire Tweed	1520	60	68.5	75
FH080SCAR	Scarlet	1520	60	68.5	75
FH080SLTH	Slate Heather	1520	60	68.5	75
FH080TAPU	Taupe	1520	60	68.5	75
FH080TRED	True Red	1520	60	68.5	75
FH080TST	Toast	1520	60	68.5	75
FH080WHT	White	1520	60	68.5	75
FH080YEL	Yellow	1520	60	68.5	75



## Specifications for Weathermax® Fabrics

- ▲ 10 Year Limited Warranty
- ▲ 8.0 oz / yd2 (271 g / m2)
- ▲ No Sagging
- ▲ No Color Bleeding or Rub-Off
- ▲ Easier Handling and Stowing
- ▲ 2X Strength & Durability
- ▲ 6X Abrasion Resistance
- ▲ 50% Higher Water Resistance
- ▲ Twice the Fade Resistance
- ▲ Double the Strength Retention
- ▲ High Water Resistance + High Breathability

## Color Availability



Note: Color representation from 4-color process is for reference purposes only. Please inquire for color sample of actual fabric.

## Weathermax 80 Bias Binding



A patented outdoor performance bias binding developed for demanding applications and environments. Super high strength and durability combine with long-term color retention to deliver a truly versatile outdoor fabric for a variety of applications.

Available in two widths, 3/4" & 1", it is the most balanced and cost-effective fabric available for marine covers and tops, awnings, or other outdoor applications requiring outstanding durability, higher water repellence and excellent breathability.

Part No.	Color	Width: mm/in		Av Roll Length: m/yd	
E069BEG	Beige	19	3/4	91.4	100
E069BK	Black	19	3/4	91.4	100
E069CNV	Captain Navy	19	3/4	91.4	100
E069GRPH	Graphite	19	3/4	91.4	100
F069LCHR	Lite Charcoal	19	3/4	91.4	100
E069MIST	Mist	19	3/4	91.4	100
E069PBU	Pacific Blue	19	3/4	91.4	100
E069SND	Sand	19	3/4	91.4	100
E069WHT	White	19	3/4	91.4	100
E070BEG	Beige	25	1	91.4	100
E070BK	Black	25	1	91.4	100
E070CNV	Captain Navy	25	1	91.4	100
E070GRPH	Graphite	25	1	91.4	100
F070LCHR	Lite Charcoal	25	1	91.4	100
E070MIST	Mist	25	1	91.4	100
E070PBU	Pacific Blue	25	1	91.4	100
E070SND	Sand	25	1	91.4	100
E070WHT	White	25	1	91.4	100



E069PBU

## Weathermax 80 Bonded Polyester Thread



- ▲ Currently available in 8 colors to match Weathermax 80
- ▲ Bonded Polyester Construction
- ▲ Made In The USA
- ▲ Weight: Approx. gm/8oz yd per spool.

Part No.	Color	Width: mm/in		Av. Spool Weight: g/oz	
EY135BEG8	Beige	19	3/4	227	8oz
EY135BK8	Black	19	3/4	227	8oz
EY135CNV8	Captain Navy	19	3/4	227	8oz
EY135GRPH8	Graphite	19	3/4	227	8oz
EY135LCHR8	Lite Charcoal	19	3/4	227	8oz
EY135MST8	Mist	19	3/4	227	8oz
EY135PBU8	Pacific Blue	19	3/4	227	8oz
EY135WHT8	White	19	3/4	227	8oz

Page Navigation

Please go to pages 117-123 for full details on the rest of the range of thread products.



Note: Color representation from 4-color process is for reference purposes only. Please inquire for color sample of actual fabric.

# New Products - Sattler 745

## SATTLER 745 Evolution



- ▲ PVC Coated Material
- ▲ Matte Varnish - helps to reduce glare
- ▲ 100% Waterproof
- ▲ Graphics Receptive
- ▲ Flame Retardant to: ASTM E 84 CI A, NFPA701, CA-T19
- ▲ REACH Compliant
- ▲ 63"/1600mm width for ease of handling
- ▲ A Multi-Range Product Ideal for:
  - Canopies, Tents, Tensile Umbrellas, Shade Structures, Awnings, and many more.
- ▲ 10 Year Limited Warranty
- ▲ 18.9 oz / yd2 (640.8 g / m2)

Sattler 745 Evolution is a flame-retardant, PVC coated textile; specifically designed for the North American markets. It boasts all of the popular new color styles. It comes standard with a matte varnish, accepting multiple type of graphic options. A durable fabric that can be used in more than one type of application, Sattler 745 Evolution gets the job done in the harshest environments.

Produced in Austria, all our fabrics fulfill strictest quality and environmental standards. This is guaranteed by ISO 9001:2015 Quality Management System and ISO 14001:2015 Environmental Management System certificates.



Part No.	Color	Width: mm/in		Av Roll Length: m/yd	
FHE745BRG	Burgundy	1600	63	26.9	29.5
FHE745BLK	Black	1600	63	26.9	29.5
FHE745BRK	Brick	1600	63	26.9	29.5
FHE745COF	Coffee	1600	63	26.9	29.5
FHE745DBU	Directoire Blue	1600	63	26.9	29.5
FHE745GGRN	Galapagos Green	1600	63	26.9	29.5
FHE745GR	Green	1600	63	26.9	29.5
FHE745OBU	Ocean Blue	1600	63	26.9	29.5
FHE745NBU	Navy Blue	1600	63	26.9	29.5
FHE745NWT	Navajo White	1600	63	26.9	29.5
FHE745OLV	Olive Green	1600	63	26.9	29.5
FHE745ORG	Orange	1600	63	26.9	29.5
FHE745QGRY	Quite Gray	1600	63	26.9	29.5
FHE745RBU	Royal Blue	1600	63	26.9	29.5
FHE745RED	Red	1600	63	26.9	29.5
FHE745SGRY	Steel Gray	1600	63	26.9	29.5
FHE745TWL	Twill	1600	63	26.9	29.5
FHE745WHT	White	1600	63	26.9	29.5
FHE745WPEP	White Pepper	1600	63	26.9	29.5
FHE745WHT	White	1600	63	26.9	29.5
FHE745YEL	Yellow	1600	63	26.9	29.5

## Color Availability



### Information

Sattler 745 Evolution®  
Please contact your Sales Representative for the latest card



Note: Color representation from 4-color process is for reference purposes only. Please inquire for color sample of actual fabric.

## SATTLER 745 EVOLUTION

MULTI-RANGE PRODUCT IDEAL FOR  
CANOPIES, TENTS, TENSILE UMBRELLAS,  
SHADE STRUCTURES, AWNINGS, AND  
MANY MORE...

- PVC Coated Material
- Matte Varnish to reduce glare
- 100% Waterproof
- Graphics Receptive
- Flame Retardant
- REACh Compliant
- 63" wide for ease of handling
- 10 year Warranty

Sattler 745 Evolution is a flame-retardant, PVC coated textile; specifically designed for the North American markets.

It boasts all of the popular new color ranges, comes standard with a matte varnish - accepting multiple type of graphic options.

A durable fabric that can be used in more than one type of application. Sattler 745 Evolution gets the job done in the harshest environments.



SATTLER CORPORATION  
Toll Free 866.688.3872  
447 Main Street, Hudson, NC 28638

[sales-usa@sattler.com](mailto:sales-usa@sattler.com)  
[www.sattler.com](http://www.sattler.com)

**SATTLER**   
thinking highTEX

## Sunbrella® New 46" Solid Colors



- ▲ 100% solution dyed Acrylic fabric
- ▲ Resists sunlight, mildew, rot and atmospheric chemicals.
- ▲ Bright and colorfast
- ▲ Use Sunbrella for: Canopies, biminis, dodgers, awnings, travel covers & camper tops.
- ▲ Weight: Approx. 305gsm/9.0oz sq yd.
- ▲ Average roll length: 54.9m/60 yards.

Part No.	Color	Width: mm/in		Av Roll Length: m/yd	
FS14609	Cloud	1168	46	54.9	60.0
FS14610	Midnight	1168	46	54.9	60.0
FS4634	White	1168	46	54.9	60.0
FS4636	Storm	1168	46	54.9	60.0
FS4659	Ember	1168	46	54.9	60.0
FS4896	Silica Sage	1168	46	54.9	60.0
FS4897	Silica Charcoal	1168	46	54.9	60.0



Page Navigation

Please go to pages 8-11 of the catalog for full details of the Sunbrella & Firesist ranges.



## Firesist



- ▲ FR product woven from high UV and fade resistant solution dyed fiber and backed with a durable urethane/acrylic coating.
- ▲ Meets NFPA-701 Test Method 11.
- ▲ Meets many other FR codes for exterior & interior use.
- ▲ Use Sunbrella for: Canopies, biminis, dodgers, awnings, travel covers & camper tops.
- ▲ Weight: Approx. 297gsm/8.75oz sq yd.

Part No.	Color	Width: mm/in		Av Roll Length: m/yd	
FS82021	Redwood	1530	60	54.8	60.0
FS82022	Flannel	1530	60	54.8	60.0
FS82023	Cedar	1530	60	54.8	60.0
FS82024	Fog	1530	60	54.8	60.0



## Sunbrella® New 60" Solid Colors



Part No.	Color	Width: mm/in		Av Roll Length: m/yd	
FS6015	Smoke	1530	60	54.9	60.0
FS6034	White	1530	60	54.9	60.0
FS6036	Midnight	1530	60	54.9	60.0
FS6064	Cloud	1530	60	54.9	60.0
FS6067	Mahogany	1530	60	54.9	60.0

## Sunbrella® New 80" Solid Colors



Part No.	Color	Width: mm/in		Av Roll Length: m/yd	
FS80026	Navy	2032	80	54.9	60.0
FS80034	White	2032	80	54.9	60.0

Note: Color representation from 4-color process is for reference purposes only. Please inquire for color sample of actual fabric.



Stamoid Light 59"



- ▲ Super lightweight coated woven polyester
- ▲ Excellent UV resistance
- ▲ Use for: Console covers, spray hoods, convertible tops, mooring covers etc.
- ▲ Weight: Approx. 254gsm/8.3oz sq yd.
- ▲ Average roll length: 50m/54.5 yards.

Part No.	Color	Width: mm/in		Av Roll Length: m/yd	
FH159CLGY	Cloud Gray	1500	59	50.0	54.5
FH159DST	Desert Sand	1500	59	50.0	54.5

Stamoid Light 102"



- ▲ Super lightweight coated woven polyester
- ▲ Excellent UV resistance
- ▲ Use for: Console covers, spray hoods, convertible tops, mooring covers etc.
- ▲ Weight: Approx. 254gsm/8.3oz sq yd.
- ▲ Average roll length: 50m/54.5 yards.

Part No.	Color	Width: mm/in		Av Roll Length: m/yd	
FH186CHAR	Charcoal	2591	102	50.0	54.5
FH186CGY	Pearl Gray	2591	102	50.0	54.5
FH186RB	Royal Blue	2591	102	50.0	54.5

Stamoid Top 59"



- ▲ Superior double coated vinyl
- ▲ Excellent UV resistance
- ▲ Use for: Console covers, spray hoods, convertible tops, mooring covers etc.
- ▲ Weight: Approx. 441gsm/12.7oz sq yd.
- ▲ Average roll length: 30m/32.8 yards.

Part No.	Color	Width: mm/in		Av Roll Length: m/yd	
FH259CHCL	Charcoal	1500	59	50.0	54.5
FH259CLGY	Cloud Gray	1500	59	50.0	54.5
FH259TP	Taupe	1500	59	50.0	54.5

Page Navigation

Please go to pages 20-25 for full details on the rest of the Serge Ferrari range.



Stamoid Top 102"



- ▲ Superior double coated vinyl
- ▲ Excellent UV resistance
- ▲ Use for: Console covers, spray hoods, convertible tops, mooring covers etc.
- ▲ Weight: Approx. 441gsm/12.7oz sq yd.
- ▲ Average roll length: 30m/32.8 yards.

Part No.	Color	Width: mm/in		Av Roll Length: m/yd	
FH258BK	Black	2591	102	30.0	32.8
FH258GY	Pearl Gray	2591	102	30.0	32.8
FH258SW	Snow White	2591	102	30.0	32.8

Stamoid Smart One 98"



- ▲ Single sided Silicon coating for easy cleaning.
- ▲ Multiple applications: Equipment and boat protection, covers for: Dinghies, rigging, consoles, seats & bars etc.
- ▲ Excellent resistance to pollution, UV and mold. Very easy to clean and excellent tear and abrasion resistance.
- ▲ Up to 60% more compact than other covers.
- ▲ Weight: Approx. 250gsm / 8.2oz sq yd
- ▲ Average roll length: 30m / 32.8 yds

Part No.	Color	Width: mm/in		Av Roll Length: m/yd	
FH260SM1BU	Blue	2489	98	30.0	32.8
FH260SM1CH	Charcoal	2489	98	30.0	32.8
FH260SM1PG	Pearl Gray	2489	98	30.0	32.8
FH260SM1TN	Tan	2489	98	30.0	32.8
FH260SM1WT	White	2489	98	30.0	32.8

Soltis 86 - 70" & 105"



- ▲ Premium vinyl coated 100dtx polyester mesh
- ▲ Excellent tensile and tear strength.
- ▲ Use for: Wind & sun screens, privacy curtains, shade awnings. Approx. 86% shade factor.
- ▲ Weight: Approx. 380gsm/11.2oz sq yd.
- ▲ Average roll length: 40m/43.7yards.

Part No.	Color	Width: mm/in		Av Roll Length: m/yd	
FH286SBG	Sandy Beige	1770	70.0	40.0	43.7
FH286BK	Black	1770	70.0	40.0	43.7
FH286GY	Boulder Mesh	1770	70.0	40.0	43.7
FH286SW	Snow White	1770	70.0	40.0	43.7
FH286WT	White	1770	70.0	40.0	43.7
FH287SBG	Sandy Beige	2667	105.0	40.0	43.7
FH287BK	Black	2667	105.0	40.0	43.7
FH287CON	Concrete	2667	105.0	40.0	43.7
FH287GY	Boulder Mesh	2667	105.0	40.0	43.7
FH287SW	Snow White	2667	105.0	40.0	43.7
FH287WT	White	2667	105.0	40.0	43.7

Note: Color representation from 4-color process is for reference purposes only. Please inquire for color sample of actual fabric.

## Top Gun Light FR - New

# TOP GUN LIGHT FR

- ▲ Great choice when needing FR spec
- ▲ High in tensile and tear strength
- ▲ 3rd party certified to pass California State Fire Marshall, NFPA 701, CPAI 84, FAA/FAR & CAN/ULC
- ▲ Puncture and Mildew resistant
- ▲ True Reversible Fabric for optimum yield.
- ▲ High in abrasion resistance
- ▲ Multi-ply construction for maximum wear and durability
- ▲ Highly water repellent
- ▲ Weight: 271gsm/8oz sq yd
- ▲ Protected by a 5 year limited warranty

Part No.	Color	Width: mm/in	Av Roll Length: m/yd
F0375A00Y	White	1600 62	45.7 50.0
F0375A47Y	Hunter Green	1600 62	45.7 50.0
F0375A60Y	Black	1600 62	45.7 50.0
F0375A97Y	Silver Gray	1600 62	45.7 50.0

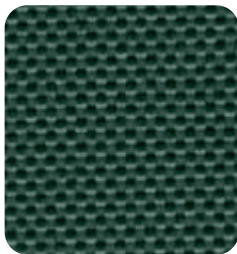

Raven Black

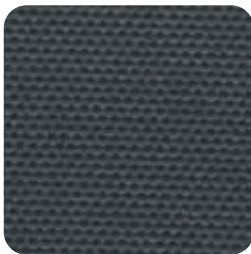

Silver Gray



White



Hunter Green



## Top Notch - New Products

# TOP NOTCH FR

- ▲ Great choice when needing FR spec
- ▲ High in tensile and tear strength
- ▲ 3rd party certified to pass California State Fire Marshall, NFPA 701, CPAI 84, FAA/FAR & CAN/ULC
- ▲ Puncture resistant
- ▲ Mildew resistant
- ▲ High in abrasion resistance
- ▲ Multi-ply construction for maximum wear and durability
- ▲ Highly water repellent
- ▲ Weight: 339gsm/10oz sq yd
- ▲ Protected by a 8 year limited warranty

Part No.	Color	Width: mm/in	Av Roll Length: m/yd
F0175A00Y	White	1530 60	26.9 29.5
F0175A10Y	Cardinal Red	1600 60	26.9 29.5
F0175A47Y	Forest Green	1600 60	26.9 29.5
F0175A60Y	Black	1600 60	26.9 29.5
F0175A65Y	Taupe	1600 60	26.9 29.5
F0175A98Y	Charcoal	1600 60	26.9 29.5

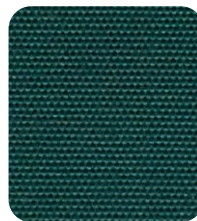

Forest Green



Charcoal



Black



White

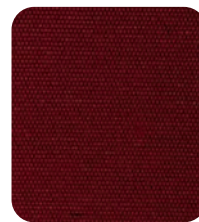

Cardinal Red



Taupe

Page Navigation

Please go to pages 28-33 for full details on the rest of the Marlen Textiles range.



Note: Color representation from 4-color process is for reference purposes only. Please inquire for color sample of actual fabric.

Textilene NANO 95

**TEXTILENE**  
BRAND FABRIC  
**nano 95**

- ▲ Flame Retardent: Meets CA Title 19, NFPA-701, CAN-ULC-S 109-03
- ▲ Reach Compliant
- ▲ RoHS Compliant
- ▲ Weight: 498gsm/14.7 oz sq. yd.
- ▲ Width: 3.2m/126 inches
- ▲ 36 x 34 construction.
- ▲ Average roll length: 30.5m/33.3 yards.



Stone



Black

Part No.	Color	Width: mm/in		Av Roll Length: m/yd	
FH353STN26	Stone	3200	126	30.5	33.3
FH353BLK26	Black	3200	126	30.5	33.3



Textilene 95

**TEXTILENE**<sup>®</sup>  
BRAND FABRIC  
**95**

- ▲ Flame Retardent: Meets CA Title 19, NFPA-701, CAN-ULC-S 109-03
- ▲ Reach Compliant
- ▲ RoHS Compliant
- ▲ Weight: 604gsm/17.8 oz sq yd.
- ▲ Width: 3.2m/126 inches
- ▲ 36 x 26 construction.
- ▲ Average roll length: 30.5m/33.3 yards.

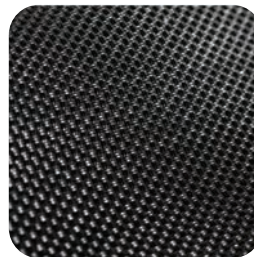

Black



Graphite

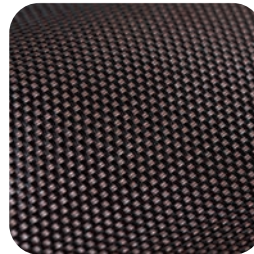

Tobacco Leaf

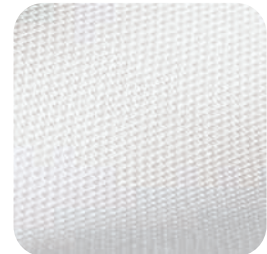

White

Part No.	Color	Width: mm/in		Av Roll Length: m/yd	
FH351ABR26	Almond Brown	3200	126	30.5	33.3
FH351TBW26	Tumbleweed	3200	126	30.5	33.3
FH351BK26	Black	3200	126	30.5	33.3
FH351GRA26	Graphite	3200	126	30.5	33.3
FH351MUS26	Mushroom	3200	126	30.5	33.3
FH351TBW26	Tumbleweed	3200	126	30.5	33.3
FH351TOB26	Tobacco Leaf	3200	126	30.5	33.3
FH351WHT26	White	3200	126	30.5	33.3

Information

Did you know that we carry a full range of track and Keder Fittings? Please ask your Sales Representative



Page Navigation

Please go to pages 44-47 for full details on the rest of the mesh fabrics range of products.



Note: Color representation from 4-color process is for reference purposes only. Please inquire for color sample of actual fabric.

## Panorama FR Clear Vinyl

- ▲ Flame Retardent - Meets CA Title 19 & NFPA-701.
- ▲ Not scratch resistant.
- ▲ Dimensionally stable.
- ▲ Sheet Size: 54" x 100".
- ▲ Use for: canopies, screens, curtains, enclosures
- ▲ Two Thicknesses - .020 and .030.
- ▲ Sold In 5 sheet drums only.

Part No.	Gauge : mm/in		Roll Width: mm/in		Sheets Per Drum
K120PFR/5	0.76	0.020	1370x2794	54x110	5
K130PFR/5	1.02	0.030	1370x2794	54x110	5

## Fenestra FR Clear Vinyl

- ▲ Flame Retardent - Meets CA Title 19 & NFPA-701.
- ▲ Not scratch resistant.
- ▲ Dimensionally stable.
- ▲ Sheet Size: 54" x 100".
- ▲ Use for: canopies, screens, curtains, enclosures
- ▲ Two Thicknesses - .020 and .030.
- ▲ Sold In 5 sheet drums only.

Part No.	Gauge : mm/in		Roll Width: mm/in		Sheets Per Drum
K220/5FR	0.76	0.020	1370x2794	54x110	5
K222/5F	1.02	0.030	1370x2794	54x110	5

## Strataglass



- ▲ .060g Now available in three sheet drums.
- ▲ Same 54" x 111" sheet size..

Part No.	Gauge Thickness: mm/in		Width: mm/in	Sheet Length: mm/in		Sheets Per Drum
K315/3	1.50	0.060	1340 52	2820	110	3



## Tuffak Polycarbonate Sheet

# TUFFAK®



### TUFFAK® AR

Part No. K560AR2

- ▲ Size: .060 x 48" x 96"

- ▲ Long term clarity and low optical distortion
- ▲ Two-sided hard coat protection against abrasion, UV and chemical attack
- ▲ Available in sewable .060" thickness
- ▲ Recommended for flat applications only

### TUFFAK® VR

Part No. K540VR

- ▲ Size - .040 x 52" x 110"

- ▲ High clarity optical alternative to vinyl
- ▲ Two-sided enhanced resistance to yellowing
- ▲ Improved cut and sew -ability over other heavy polycarbonates
- ▲ Available in .040" thickness
- ▲ Can be rolled-works for both flat and curved applications

### TUFFAK® Marine 5

Part No. K560M5

- ▲ Size - .040 x 50" x 110"

- ▲ High clarity optical alternative to vinyl
- ▲ Two-sided enhanced resistance to yellowing
- ▲ Improved cut and sew -ability over other heavy polycarbonates
- ▲ 5 Year Limited Warranty on Yellowing, Breakage, Micro-cracking

## Tuffak Polycarbonate

Part No.	Gauge Thickness: mm/in		Width: mm/in		Sheet Length: mm/in		Sheets Per Drum
K540VR	1.02	0.040	1340	52	2820	110	Per Sheet
K560AR2	1.50	0.060	1219	48	2432	96	Per Sheet
K560M5	1.50	0.060	1270	50	2820	110	Per Sheet

Note: Color representation from 4-color process is for reference purposes only. Please inquire for color sample of actual fabric.

## Nautolex Voyager



- ▲ Premium UV protected marine grade expanded vinyl upholstery fabric with knitted fabric backing- Now in Soft Sand.
- ▲ 600 hour UV resistance.
- ▲ The unique Nautolex formula with PreFixx ensures an overall protective performance.
- ▲ Expanded vinyl has a fabric mesh backing for reduced stretch.
- ▲ Mildew resistant.
- ▲ Designed to meet California Flammability Regulation 117-75, Sec.E.
- ▲ Outstanding stain resistance and cleanability.
- ▲ Superior abrasion resistance.
- ▲ Eliminates blocking and prevents premature aging.
- ▲ Weight: 678gsm/30oz per linear yard.



Mystic White

Off-White

Soft Sand

Part No.	Color	Width: mm/in	Av Roll Length: m/yd
F0900A008	Mystic White	1370 54	27 30
F0900A058	Off-White	1370 54	27 30
F0900A088	Soft Sand	1370 54	27 30



## Nautolex Voyager Channel Upholstery Quilt, Roll & Pleat



- ▲ Marine grade Nautolex vinyl with PreFixx and 224gsm/6.6 ounce, 100% polyester batting and liner. The channels in our material are 38mm/1 1/2 inches apart.
- ▲ Please note channels run perpendicular to the edge of the roll and do not extend the full distance edge to edge. The actual usable material is only 1320mm/52 inches wide.
- ▲ Weight: 916gsm/37oz per linear yard.



Mystic White

Soft Sand

Off-White

Part No.	Color	Width: mm/in	Av Roll Length: m/yd
F0900C008	Mystic White	1370 54	13 14
F0900C058	Off White	1370 54	13 14
F0900C088	Soft Sand	1370 54	13 14



## Nautolex Tidal Wave



- ▲ Premium UV protected marine grade expanded vinyl upholstery fabric with knitted fabric backing.
- ▲ The unique Nautolex formula with PreFixx ensures an overall protective performance.
- ▲ Mildew resistant.
- ▲ Designed to meet California Flammability Regulation 117-75, Sec.E.
- ▲ Outstanding stain resistance and cleanability.
- ▲ Superior abrasion resistance.
- ▲ 2 Year Anti-Pinking Warranty
- ▲ Weight: 678gsm/30oz per linear yard.



Pure White

Silken White



Capitano White

Sofdura White

Part No.	Color	Width: mm/in	Av Roll Length: m/yd
F0902P008	Voyager Pure White	1370 54	36.6 40
F0904P008	Capitano Pure White	1370 54	36.6 40
F0905P008	Sofdura Pure White	1370 54	36.6 40
F0907P008	Silken Pure White	1370 54	36.6 40

## Nautolex Tidal Wave Channel Quilt



- ▲ Marine grade Nautolex Tidal Wave vinyl with PreFixx. 224gsm/6.6 ounce, 100% polyester batting and liner
- ▲ Channels in our material are 38mm/1 1/2 inches apart.
- ▲ Please note channels run perpendicular to the edge of the roll and do not extend the full distance edge to edge. The actual usable material is 1320mm/52 inches wide.
- ▲ Weight: 916gsm/37oz per linear yard.

Part No.	Color	Width: mm/in	Av Roll Length: m/yd
F0902CC008	Voyager Pure White	1370 54	13 14

Note: Color representation from 4-color process is for reference purposes only. Please inquire for color sample of actual fabric.

## Morbern Allsport Upholstery Vinyl

- ▲ Very Durable
- ▲ Stretches both directions
- ▲ UV Resistant
- ▲ Roll Length: 40yds/64m
- ▲ Width: 54"/1370mm
- ▲ Weight: 28oz per square yard



Part No.	Color	Width: mm/in		Av Roll Length: m/yd	
F0967A998	Black	1600	63	64	70

## Nautolex Voyager Hidem



- ▲ Hidem Gimp is made from premium marine grade Nautolex vinyl with PreFixx specially folded onto itself and sewn at both edges to form a 15.9mm / 5/8" binding used to hold/hide staples or tacks and serves to trim/bind fabricated pieces.
- ▲ Hidem is sold in full reels only.



Part No.	Color	Width: mm/in		Av Roll Length: m/yd	
LS603WT	Mystic White	15	5/8	22.8	25
LS603OW	Off White	15	5/8	22.8	25
LS603SS	Soft Sand	15	5/8	22.8	25

## Nautolex Voyager Welt



- ▲ 5/32" Upholstery Welt.
- ▲ Sold In full 50 yard reels only.
- ▲ Now in Soft Sand as well as Mystic White & Off White.



Part No.	Color	Width: mm/in		Av Roll Length: m/yd	
LS605WT	Mystic White	3.968	5/32"	45.9	50
LS605OWT	Off White	3.968	5/32"	45.9	50
LS605SS	Soft Sand	3.968	5/32"	45.9	50

## CoverFlex - Non Woven Cover Fabric

- ▲ Soft Hand
- ▲ Multi Layers of: Polypropylene/Polyethylene/Polyester
- ▲ Breathable
- ▲ UV Resistant
- ▲ Roll Length: 70yds/64m
- ▲ Width: 63"/1600mm
- ▲ Grey Variegated Top with a White Underside

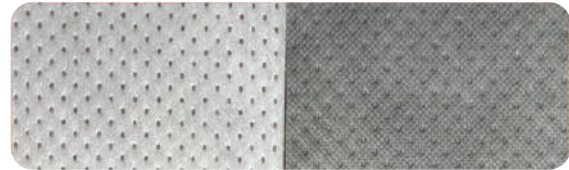

Part No.	Color	Width: mm/in		Av Roll Length: m/yd	
F0255A97Y	Translucent	1600	63	64	70

CoverFlex replaces Evolution 4 as that product is now no longer available.



## Pattern-X2

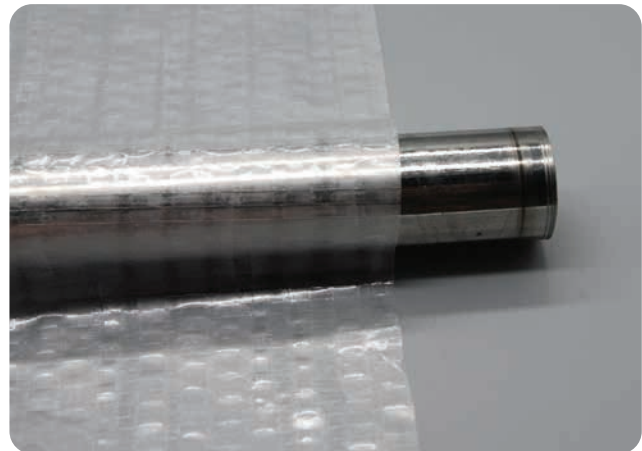

- ▲ Seam tapes stick well
- ▲ Double coated film
- ▲ Dimensionally stable woven Polyethylene
- ▲ FP087-144 is centerfolded to ship by UPS or van at 72".
- ▲ Colors: Natural/Translucent Only.

Part No.	Color	Width: mm/in		Av Roll Length: m/yd	
FP085/72	Translucent	1829	72	91.4	100
FP087/144	Translucent	3658	144	45.7	50 (Folded)

Note: Color representation from 4-color process is for reference purposes only. Please inquire for color sample of actual fabric.

NEW! Bainbridge Brand #10 Zippers



- ▲ Seven Popular Lengths.
- ▲ Available in #10 Size Only.
- ▲ Double Metal Locking Pulls.
- ▲ Available Singly or in Pack Quantities.
- ▲ Black or White.



Part No.	Length & Description	Pack Quantity
EJ560BK	24" No. 10 BI Jacket Zip Black Double Pull	20
EJ560WT	24" No. 10 BI Jacket Zip White Double Pull	20
EJ561BK	36" No. 10 BI Jacket Zip Black Double Pull	20
EJ561WT	36" No. 10 BI Jacket Zip White Double Pull	20
EJ563BK	48" No. 10 BI Jacket Zip Black Double Pull	20
EJ563WT	48" No. 10 BI Jacket Zip White Double Pull	20
EJ565BK	60" No. 10 BI Jacket Zip Black Double Pull	20
EJ565WT	60" No. 10 BI Jacket Zip White Double Pull	20
EJ567BK	72" No. 10 BI Jacket Zip Black Double Pull	20
EJ567WT	72" No. 10 BI Jacket Zip White Double Pull	20
EJ570BK	84" No. 10 BI Jacket Zip Black Double Pull	20
EJ570WT	84" No. 10 BI Jacket Zip White Double Pull	20
EJ572BK	96" No. 10 BI Jacket Zip Black Double Pull	20
EJ572WT	96" No. 10 BI Jacket Zip White Double Pull	20

Page Navigation

Please go to pages 124-129 for full details on the rest of the YKK & Bainbridge Zipper Products.



KAI™ Shears

The KAI V7000 Series is a new range of high quality stainless steel shears from Japan.

- ▲ Patented duplex interlocking screw that prevents it becoming loose.
- ▲ Matte Finish.



KAI 7250 Part No. C7250 or C7250LF (Left Handed)  
10.0" / 25.5 cm Length



KAI 7280 Part No. C7280  
11.0" / 28.0 cm Length



KAI 7300 Part No. C7300  
12.0" / 30.5 cm Length



KAI 7240as Part No. C7240ASM  
9.5" / 24.0 cm length  
Optimal for aramid fabrics and Polycarbonate sheet



Pt No.	Description
C7250	KAI Brand #7250 General Purpose Shears - 10"/25cm
C7280	KAI Brand #7280 General Purpose Shears - 11"/28cm
C7300	KAI Brand #7300 General Purpose Shears - 12"/30cm
C7240AS	KAI Brand #7240as Shears for Aramid/Polycarbonate - 12"/30cm
C7250LF	KAI Brand #7250 Left Hand General Purpose Shears - 10"/25cm

Note: Color representation from 4-color process is for reference purposes only. Please inquire for color sample of actual fabric.

New Products

## Capt Tolley's

- ▲ Penetrating Crack Sealant Finds and Fixes Leaks
- ▲ Forms a flexible, long lasting waterproof seal.
- ▲ Unique capillary action for unparalleled penetration into hairline cracks.
- ▲ Compatible with: Fiberglass/Wood/Rubber/Glass/ Metals/Stone/Brick/Concrete/Hard Plastics/Ceramics.



Part No.	Description	Size:	Pack Quantity
M501C	Capt Tolley's	2 fl. oz.	12
M501-8	Crack Sealant	8 fl. oz.	12

## Tenara

- ▲ Tenara 1003 HTR Style
- ▲ Three New Colors
- ▲ Fabric covered by 10 year limited warranty.
- ▲ 8oz Spools



Part No.	Color	Spool Weight: gm/oz		Av Roll Length: m/yd	
EG103HTGY	Dark Gray	226.8	8	26.9	29.5
EG103HTNVY	Navy Blue	226.8	8	26.9	29.5
EG103HTSND	Sandstone	226.8	8	26.9	29.5

### Page Navigation

Please go to pages 122-123 for full details on the rest of the Tenara thread line of products



## Stainless Steel Track Feeder Fittings

- ▲ Designed to fit G512 Flex-A-Rail Track
- ▲ Sold Per Piece
- ▲ Manufactured from 316 stainless steel



Part No.	Color	Application:	Pack Quantity
G235S	Stainless Steel	Fits Flex-A-Rail	Sold each

- ▲ Designed to fit G515 Costa Track
- ▲ Sold Per Piece
- ▲ Manufactured from 316 stainless steel



Part No.	Color	Application:	Pack Quantity
G724S	Stainless Steel	Fits Costa Track	Sold each

## Boat Vent Aero

- ▲ Sew-on to fabric to vent enclosures etc.
- ▲ Available in two sizes - Medium & Large
- ▲ Both sizes come in black and white.



Part No.	Color	Application:	Pack Quantity
G058BK	Black	7.5" Rubber	Sold each
G058WT	White	7.5" Rubber	Sold each
G059BK	Black	10.5" Rubber	Sold each
G059WT	White	10.5" Rubber	Sold each

Note: Color representation from 4-color process is for reference purposes only. Please inquire for color sample of actual fabric.



## Carbiepoles - Carbon Sun Shade Poles

- ▲ Manufactured from Toray T500 Carbon Fiber
- ▲ Light & Very Strong
- ▲ Adjustable Height
- ▲ Fits most rod holders
- ▲ Available in five colors
- ▲ Complete with quality block and line
- ▲ Length: Max. 88"/2235mm
- ▲ Gloss Finish
- ▲ Made In The USA



Pt No.	Description
G548BK	Carbie Pole Carbon Shade Pole - 88" max. Black
G548WHT	Carbie Pole Carbon Shade Pole - 88" max. White
G548SLVR	Carbie Pole Carbon Shade Pole - 88" max. Silver
G548RED	Carbie Pole Carbon Shade Pole - 88" max. Red
G548BLUE	Carbie Pole Carbon Shade Pole - 88" max. Blue
G548BAG	Storage Bag For One Pair of CarbonSun Shade Poles

## Modular Spur Grommet Die Set

- ▲ High Quality
- ▲ Available in six sizes



Pt No.	Description
C303MS	Modular Spur Grommet - Basic Die Set No 0
C304MS	Modular Spur Grommet - Basic Die Set No 1
C305MS	Modular Spur Grommet - Basic Die Set No 2
C306MS	Modular Spur Grommet - Basic Die Set No 3
C307MS	Modular Spur Grommet - Basic Die Set No 4
C308MS	Modular Spur Grommet - Basic Die Set No 5

## HELIOS PTFE Thread

- ▲ Coats Helios P is the strongest polytetrafluoroethylene (PTFE) sewing thread on the market
- ▲ Helios P is ideal for outdoor goods which are exposed to harsh weather conditions (ultraviolet rays, rain, salt water) like awnings, boat covers and sails.



Part No.	Color	Spool Weight: gm/oz		Av Roll Length: m/yd	
EC150BLK	Black	226.8	8	26.9	1700
EC150CLR	Clear	226.8	8	26.9	1700
EC150WHT	White	226.8	8	26.9	1700
EC200BLK	Black	226.8	8	26.9	1000
EC200CLR	Clear	226.8	8	26.9	1000
EC200WHT	White	226.8	8	26.9	1000

## Bainbridge Nauti Carbon Shade Pole™

- ▲ The new telescoping shade pole is made from black carbon fiber and is the ideal solution for lightweight and easy to install shade supports. Nauti Carbon Shade Pole™ can be used for: Marine Awnings, Shade Sails, Bow Shades etc.
- ▲ Carbon Fiber Construction
- ▲ Telescopic (56-92")
- ▲ 1.5" Diameter
- ▲ Stainless O-Ring
- ▲ Adjustment Clamp
- ▲ Fits Rod Holders



Part No.	Color	Application:	Pack Quantity
G549nautBK	Black Carbon	Fits Rod Holders	Sold each

Note: Color representation from 4-color process is for reference purposes only. Please inquire for color sample of actual fabric.

## NEW SAILCLOTH PRODUCTS



### NEW PREMIUM SAILCLOTH

#### SPX Balanced 25 - Storm Orange

Part Number	Description	Construction Warp x Fill	Weight		Width in
			gsm	sm oz	
FWP082520	SPX 825 Storm Orange	450 x 750	364	8.5	54
FWP102520	SPX 1025 Storm Orange	750 x 1000	451	10.6	54

#### SPX Strong Fill 55 - Quality Woven Sailcloth

Part Number	Description	Construction Warp x Fill	Weight		Width in
			gsm	sm oz	
FWP075500	SPX 755 Strong Fill	252 x 850	329	7.6	54
FWP085500	SPX 855 Strong Fill	252 x 1008	353	8.3	54
FWP095500	SPX 955 Strong Fill	450 x 846	415	9.7	54
FWP105500	SPX 1055 Strong Fill	450 x 1000	455	10.7	54
FWP115500	SPX 1155 Strong Fill	450 x 1300	480	11.7	54

#### SPX - PSA Woven Polyester Adhesive Sailcloth

Part Number	Description	Weight		Width in
		gsm	sm oz	
FWP0600A	SPX 6oz - PSA Woven Polyester Sailcloth	292	6.8oz	54
FWP0700A	SPX 7oz - PSA Woven Polyester Sailcloth	306	7.9oz	54



#### AIRX-800N: Premium 53gsm Nylon

Part Number	Description	Color	Weight		Width in
			gsm	sm oz	
F5180A00Y	AIRX-800N	Arctic White	53	1.23	60
F5180A08Y	AIRX-800N	Silver	53	1.23	60
F5180A10Y	AIRX-800N	Red	53	1.23	60
F5180A19Y	AIRX-800N	Aqua	53	1.23	60
F5180A15Y	AIRX-800N	Royal Blue	53	1.23	60
F5180A35Y	AIRX-800N	Yellow	53	1.23	60
F5180A60Y	AIRX-800N	Black	53	1.23	60
F5180A90Y	AIRX-800N	Tempest Gray	53	1.23	60

Other colors are available to Special Order - Please call for details.

Note: Color representation from 4-color process is for reference purposes only. Please inquire for color sample of actual fabric.

## NEW SAILCLOTH PRODUCTS



### HYBRID POLYESTER SAILCLOTH

Hybrid Polyester/Polyester Matrix weave - Balanced Construction - UV Protected - Super Tenacity

#### HSX-V Premium Hybrid Woven Polyester Sailcloth

Part Number	Description	Weight		Width in
		gsm	sm oz	
FWP062600	HSX-P 626 6oz - White Polyester Woven Sailcloth	273	6.24	54
FWP072600	HSX-P 726 7oz - White Polyester Woven Sailcloth	341	7.97	54
FWP082600	HSX-P 826 8oz - White Polyester Woven Sailcloth	390	9.11	54
FWP092600	HSX-P 926 9oz - White Polyester Woven Sailcloth	429	10.02	54
FWP072692	HSX-P 726 7oz - Grey Polyester Woven Sailcloth	341	7.97	54
FWP082692	HSX-P 826 8oz - Grey Polyester Woven Sailcloth	390	9.11	54
FWP092692	HSX-P 926 9oz - Grey Polyester Woven Sailcloth	429	10.02	54



Hybrid Polyester/Vectran Matrix weave creates a Vectran "cage" within the cloth - Balanced Construction - UV Protected - Super Tenacity

#### HSX-V Premium Hybrid Woven Polyester Sailcloth

Part Number	Description	Weight		Width in
		gsm	sm oz	
FWP062700	HSX-V 6oz - Vectran/ Polyester Woven Sailcloth	263	6.21	54
FWP072700	HSX-V 7oz - Vectran/ Polyester Woven Sailcloth	328	7.66	54
FWP082700	HSX-V 8oz - Vectran/ Polyester Woven Sailcloth	371	8.66	54
FWP092700	HSX-V 9oz - Vectran/ Polyester Woven Sailcloth	401	9.37	54



NEW SAMPLE SWATCH CARDS ARE NOW AVAILABLE FOR ALL STYLES - ASK YOUR SALES REPRESENTATIVE

Note: Color representation from 4-color process is for reference purposes only. Please inquire for color sample of actual fabric.

## Color Chart



## Specifications for Sunbrella® Fabrics

- ▲ 100% solution dyed woven acrylic fabrics in: 1170mm/46", 1520mm/60", 2032mm/80" widths.
- ▲ Excellent fade & weather resistance, durable, UV resistant.
- ▲ Colorfast, water repellent, mildew and stain resistant.
- ▲ Fabric covered by 10 year limited warranty.
- ▲ Average roll length: 59m/65 yards.
- ▲ Weight: 305gsm/9oz sq yd.



Note: Color representation from 4-color process is for reference purposes only. Please inquire for color sample of actual fabric.

## Color Availability

117cm/46 inch Part No.	152cm/60 inch Part No.	203cm/80 inch Part No.	Color
FS4600	FS6000		Erin Green
FS4601	FS6001	FS80001	Pacific Blue
FS4602	FS6002		Sunflower Yellow
FS4603	FS6003		Jockey Red
FS4604	FS6004		Natural
FS4605	FS6005		Hemlock Tweed
FS4606	FS6006		Dubonnet Tweed
FS4607	FS6007		Charcoal Tweed
FS4608	FS6008	FS80008	Jet Black
FS4609	FS6009		Orange
FS4610	FS6010		Turquoise
FS4612			Aruba
FS4614			Tan
FS4615			Smoke
FS4616	FS6016		Mocha
FS4617	FS6017		Royal Blue
FS4618	FS6018		Walnut Brown
FS4620	FS6020		Beige
FS4621	FS6021		True Brown
FS4622	FS6022		Terracotta
FS4623	FS6023		Aquamarine
FS4624	FS6024		Sky Blue
FS4626	FS6026		Navy Blue
FS4628	FS6028	FS80028	Toast
	FS6028TWD		Toast Tweed
FS4630	FS6030	FS80030	Cadet Gray
FS4631	FS6031	FS80031	Burgundy
FS4632	FS6032		Ivy
FS4633	FS6033		Linen
FS4635			Buttercup
FS4637	FS6037	FS80037	Forest Green
FS4640	FS6040		Black Cherry
FS4641	FS6041		Sapphire Blue
FS4642	FS6042		Oyster
FS4643	FS6043		Persian Green
FS4644	FS6044		Charcoal Gray
FS4645	FS6045		Sea Grass Green
FS4646	FS6046	FS80046	Captain Navy
FS4648	FS6048		Taupe
FS4651	FS6051		Silver
FS4652	FS6052		Mediterranean Blue
FS4653	FS6053		Mediterranean Tweed
FS4654	FS6054		Linen Tweed
FS4655	FS6055		Alpine
FS4658	FS6058		Tresco Brass
FS4660			Crest Birch
FS4661			Crest Denim
FS4662			Crest Ash
FS4663			Hyacinth
FS4664			Sea
FS4665	FS6065		Concord
FS4666	FS6066		Logo Red
FS4667	FS6067		Mahogany
FS4668			Aspen
FS4671			Fern
FS4672	FS6072		Heather Beige
FS4673			Spa

117cm/46 inch Part No.	152cm/60 inch Part No.	203cm/80 inch Part No.	Color
FS4674	FS6074		Wheat
FS4675	FS6075		Capri
FS4676	FS6076		Cocoa
FS4677	FS6077		Tuscan
FS4678	FS6078		Marine Blue
FS4679	FS6079		Ocean Blue
FS4683	FS6083		Parchment
FS4684	FS6084		Slate
FS4685			Ginkgo
FS4688			Basil
FS4689			Rust
FS4695			Tresco Linen
FS4696			Tresco Birch
FS4697			Tresco Ginger
FS4698			Tresco Clay
FS4699			Tresco Brick
FS4858			Silica Barley
FS4859			Silica Dune
FS4860			Silica Sesame
FS4861			Silica Stone
FS4862			Silica Silver
FS4896			Silica Sage
FS4897			Silica Charcoal



Page Navigation

Sunbrella® Limited Warranties from Glen Raven Mills Inc.

Please turn to page 15 for full details of the limited warranties for Sunbrella products.



Note: Color representation from 4-color process is for reference purposes only. Please inquire for color sample of actual fabric.

## Color Availability

Part No.	Description
FS4751	Hemlock Tweed Fancy
FS4755	Pacific Blue Fancy
FS4762	Era Corn Silk
FS4763	Era Indigo
FS4766	Era Ash
FS4767	Preston Radiance
FS4768	Preston Stone
FS4770	Providence Americana
FS4776	Chocolate Chip Fancy
FS4777	Gray/Beige Chip Fancy
FS4778	Essex Curry
FS4789	Manhattan Classic
FS4790	Forest Green Fancy
FS4796	Beige/White Fancy
FS4798	Burgundy/Black/White
FS4799	Gray/Black/White
FS4806	Forest Green/Natural 6 Bar
FS4813	Eastland Redwood
FS4817	Westfield Mushroom
FS4855	Colonnade Fossil
FS4856	Colonnade Juniper
FS4857	Colonnade Redwood
FS4868	Kiawah Spa
FS4876	Manhattan Fog
FS4878	Rodanthe Sunrise
FS4879	Rodanthe Metallic
FS4884	Saxon Cascade
FS4885	Saxon Chili
FS4887	Westport
FS4888	Clinton Granite
FS4889	Courtland Pebble
FS4891	Manhattan Dune
FS4894	Motive Dusk
FS4895	Motive Denim
FS4901	Captain Navy/Forest Green/Yellow/Red
FS4902	Captain Navy/Natural Classic
FS4907	Taupe Five Bar
FS4909	Plum Fancy
FS4916	Navy/Taupe Fancy
FS4921	Mediterranen/Canvas Block Stripe
FS4923	Black Forest Fancy
FS4932	Forest Green/Beige/Natural
FS4939	Brass/Black Cherry Classic
FS4945	Taupe Tailored Bar Stripe
FS4946	Black/Taupe Fancy
FS4948	Sapphire Vintage Bar Stripe
FS4949	Forest Vintage Bar Stripe
FS4954	Heather Beige Classic
FS4955	Fern Classic
FS4959	Fern/Heather Beige Block Stripe
FS4961	Putty Regimental
FS4969	Henna/Fern

### Page Navigation

Sunbrella® Stripes Color Card  
Please turn to pages 54 & 55 for  
the latest color swatch card for  
Sunbrella Stripe products.



## Sunbrella® Stripe

- ▲ 100% solution dyed woven acrylic fabric in 1170mm/46 inch widths.
- ▲ Excellent fade and weather resistance.
- ▲ Durable, UV resistant.
- ▲ Colorfast, water repellent, mildew and stain resistant.
- ▲ Breathable for moisture evaporation/cooler covered area.
- ▲ Fabric covered by 10 year limited warranty.
- ▲ Average roll length: 59m/65 yards.
- ▲ Weight: 305gsm/9oz sq yd.

Part No.	Description
FS4985	Havelock Brick
FS4987	Cooper Navy
FS4988	Cooper Black
FS4989	Hatteras Raven
FS4991	Manteo Cardinal
FS4992	Baycrest Sky
FS4993	Baycrest Pacific
FS4994	Eastridge Cocoa
FS4995	Ashford Forest
FS5702	Yellow/White 6 Bar Stripe
FS5704	Black/White 6 Bar Stripe S



Note: Color representation from 4-color process is for reference purposes only. Please inquire for color sample of actual fabric.



Firesist



- ▲ Fire-retardant product woven from high UV and fade resistant, solution dyed fiber & backed with a durable urethane/acrylic coating.
- ▲ Meets NFPA701-99, test method II fire retardant spec.
- ▲ Meets CSFM Title 19, CPAI-84 FR codes.
- ▲ Weight: Approx. 297 gsm/8.75oz sq yd.
- ▲ Width: 1520mm/60".
- ▲ Roll Length: 59m/65 yards



Page Navigation

Sunbrella® Bias Bindings

Please turn to pages 17-19 for the details of the full range of acrylic binding products



INFORMATION

POINT

### Sunbrella Products Care & Cleaning

Sunbrella® fabric should be cleaned regularly before substances such as dirt, roof particles, etc. are allowed to accumulate on and then become embedded in the fabric.

Clean the fabric only with mild detergent solution and rinse well. Do not allow the fabric to be folded up for long periods of time when wet.

Please refer to the full cleaning instructions on the manufacturers color swatch card. See page 147 for approved cleaning products.

Part No.	Color	Finished Width: mm/in	
FS82000	Regatta	1520	60
FS82002	Forest Green Tweed	1520	60
FS82003	Forest Green	1520	60
FS82005	Regatta Tweed	1520	60
FS82006	Sand	1520	60
FS82008	Black	1520	60
FS82010	Admiral Navy	1520	60
FS82012	Toasty Beige	1520	60
FS82013	Sunburst Yellow	1520	60
FS82014	Terracotta	1520	60
FS82015	Ivory	1520	60
FS82016	Burgundy	1520	60
FS82017	Crimson Red	1520	60
FS82030	Gray	1520	60

Page Navigation

Firesist® Color Card

Please turn to page 56 for more details on the full range and the full size color swatch card for Firesist from Glen Raven Mills.



Note: Color representation from 4-color process is for reference purposes only. Please inquire for color sample of actual fabric.

## Sunbrella® Furniture Fabrics

- ▲ A lighter weight version of Sunbrella's 100% solution dyed acrylic.
- ▲ Resists UV, mildew, rot and atmospheric chemicals.
- ▲ Limited five year warranty.
- ▲ Colors available to special order.
- ▲ Weight: 271gsm/8oz/sq yd.
- ▲ Width: 1372mm/54".



 Please call your Bainbridge Sales Representative for a copy of the latest upholstery fabrics swatch card to view the full range of styles available.



Stripes - 50+ Patterns



Dupione - 25+ Colors



Canvas - 60+ Colors



Sailcloth - 10+ Colors



Decorative Patterns - 50+ Patterns



Linen - 10+ Colors



Spectrum - 10+ Colors

Page Navigation

Upholstery Fabrics  
 Please turn to pages 36-42 for more upholstery fabrics.





smart, stylish,

right at home.



we live to be

on the water.



[sunbrella.com](http://sunbrella.com)

sunbrella®

## Color Availability



Hemlock



Royal Blue



Dubonnet



Cadet Gray



Charcoal



Black



Linen Tweed



Linen

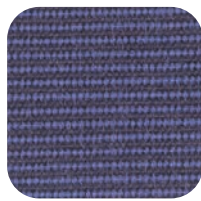

Mediterranean  
Tweed



Pacific Blue

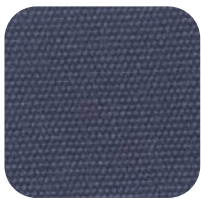

Navy Blue



Toast Tweed



Captain Navy



Forest Green



Oyster



## SeaMark Marine Fabric

- ▲ Best of both worlds - a beautiful color fast fabric with the added durability of vinyl.
- ▲ Sunbrella woven acrylic on the top side for UV durability and vibrant color.
- ▲ Marine grade vinyl - textured embossing on the bottom color matches the acrylic.
- ▲ Abrasion resistant on vinyl.
- ▲ Waterproof.
- ▲ Weight: 509gsm/15oz/sq yd.



Part No.	Color	Width: mm/in		Av Roll Length: m/yd	
F0400A82Y	Hemlock Tweed	1520	60	45.7	50
F0400A96Y	Dubonnet Tweed	1520	60	45.7	50
F0400A97Y	Cadet Gray	1520	60	45.7	50
F0400A98Y	Charcoal Tweed	1520	60	45.7	50
F0400A99Y	Black	1520	60	45.7	50
F0400A07Y	Linen	1520	60	45.7	50
F0400A09Y	Linen Tweed	1520	60	45.7	50
F0400A17Y	Mediterranean Tweed	1520	60	45.7	50
F0400A18Y	Pacific Blue	1520	60	45.7	50
F0400A22Y	Navy Blue	1520	60	45.7	50
F0400A28Y	Toast Tweed	1520	60	45.7	50
F0400A33Y	Captain Navy	1520	60	45.7	50
F0400A37Y	Forest Green	1520	60	45.7	50
F0400A42Y	Oyster	1520	60	45.7	50
F0400A79Y	Royal Blue Tweed	1520	60	45.7	50

**SeaMark Care & Cleaning**  
 SeaMark® fabric should be cleaned regularly before substances such as dirt, roof particles, etc. accumulate on and become embedded in the fabric.  
 Please refer to the cleaning instructions for Sunbrella products on page 16.

Note: Color representation from 4-color process is for reference purposes only. Please inquire for color sample of actual fabric.



## Sunbrella® Marine, Awning, Firesist, Plus. Care & Cleaning



Sunbrella® fabric should be cleaned regularly before substances such as dirt, roof particles, etc. are allowed to accumulate on and become embedded in the fabric. The fabric can be cleaned without being removed from the installation. Simply brush off any loose dirt, roof particles etc; hose down and clean with a mild solution of natural soap in lukewarm water (no more than 100°F). Rinse thoroughly to remove soap. **DO NOT USE DETERGENTS.** Allow to air dry.

For more stubborn cases: Soak the fabric for approximately twenty minutes in a solution of no more than 1/2 cup (4oz) of a non-chlorine bleach and 1/4 cup (2oz) natural soap per gallon of water at approximately 100°F. Rinse thoroughly in cold water to remove all of the soap. Note: excessive soaking in non-chlorine bleach can deteriorate sewing threads. This method of cleaning may remove part of the water repellency and the fabric should receive an application of an air-curing fluorocarbon water repellent treatment, such as 303 Hi Tech Fabric Guard, if water repellency is a factor - see page 149.

Sunbrella® is made from 100% solution dyed acrylic fiber which is thermoplastic. **DO NOT SUBJECT TO EXCESSIVE HEAT.**

When Sunbrella® fabric is stored, it should be cleaned, allowed to air dry and stored in a dry, well ventilated area.

### Page Navigation

Sunbrella® Cleaning & Protection  
Please turn to page 145 for the full range of cleaning and protection products approved for use on Sunbrella products



## Sunbrella® Limited Warranties from Glen Raven Mills Inc.

### For Sunbrella® Shade, Marine and Plus.

This warranty is valid only if the accompanying certificate is completed and mailed within 10 days of installation.

#### What is covered?

This warranty covers the fabric becoming unserviceable because of loss of color or strength from normal exposure conditions, including sunlight, mildew, rot and atmospheric chemicals. It does not cover labor and installation supplied by the dealer.

#### How long is the coverage period?

The warranty runs for 10 years from the date of original installation.

#### What will Glen Raven do?

Glen Raven will supply new fabric free to replace the fabric which becomes unserviceable.

#### How can you get service?

Call the dealer from whom you purchased the product to inspect the installation. Or call another Sunbrella® dealer listed in the Yellow Pages under "Awnings & Canopies" or "Boat Tops & Covers". The dealer will contact Glen Raven and secure replacement fabric for you.

#### How does state law apply?:

This warranty gives you specific legal rights and you may also have other rights which vary from state to state.



Note: Color representation from 4-color process is for reference purposes only. Please inquire for color sample of actual fabric.

## Sunbrella Custom Facings

- ▲ 100% solution dyed acrylic.
- ▲ Pre-folded & bonded - allows a clean, neat finished edge.
- ▲ Available in two sizes:
  - 50mm/2" facing has 25.4mm/1" & 12.7mm/1/2" folds.
  - 38mm/1 1/2" facing has 12.7mm/1/2" & 19mm/3/4" folds.
- ▲ Available only on full reels of 55m/60 yards.



E091GY

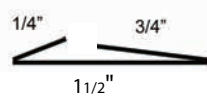

E092BK

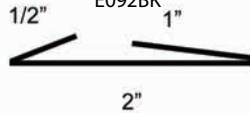

38mm/1 1/2 inch Part No	50mm/2 inch Part No	Color
E091BK	E092BK	Black
E091NV	E092NV	Navy
E091BU	E092BU	Pacific Blue
E091TST	E092TST	Toast
E091GY	E092GY	Cadet Grey
E091LN	E092LN	Burgundy
E091MBU	E092MBU	Linen
E091RB	E092RB	Marine Blue
E091CNV	E092CNV	Medditerranean Blue
E091FGR	E092FGR	Royal Blue
		Captain Navy
		Forest Green



## Acrylic 5/8" Awning Braid

- ▲ 100% solution dyed Sunbrella® acrylic yarn.
- ▲ Awning braid easily conforms to curves, scallop tight radius and valences etc.
- ▲ Available in three popular colors.
- ▲ Sold in full 132 meter/144 yard reels.
- ▲ 16 mm - 5/8" width.



E093WT



E093BK

Part No.	Color
E093BK	Black
E093FG	Forest Green
E093WT	White

## Acrylic 13/16" Awning Braid

- ▲ 100% solution dyed Sunbrella® acrylic yarn.
- ▲ Awning braid easily conforms to curves, scallop tight radius, valences etc.
- ▲ Available in twelve popular colors.
- ▲ Sold in full 132 meter/144 yard reels.
- ▲ 22mm - 13/16" width.



E094BK



E094NV

Part No.	Color
E094BK	Black
E094BG	Burgundy
E094BRN	Brown
E094CNV	Captain Navy
E094FG	Forest Green
E094GY	Gray
E094LN	Linen
E094NV	Navy
E094RD	Red
E094TC	Terracotta
E094TST	Toast
E094WT	White

## Sunstop® Thread



- ▲ 15 Sunbrella® matching colors.
- ▲ Bonded Polyester, Anti-Wick Thread.
- ▲ Supplied on half pound (8oz) spools/sold per spool.
- ▲ Available in V92 and V138 sizes.



Black



Forest Green



Silver



Logo Red



Cadet Grey

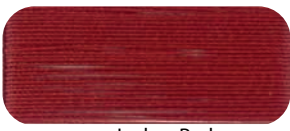

Jockey Red



Linen

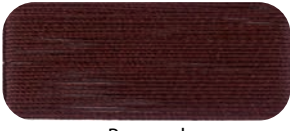

Burgundy



Toast



Pacific Blue



Beige

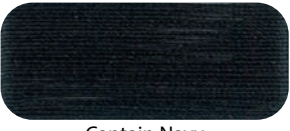

Captain Navy



True Brown



Navy

92 Part No.	138 Part No.	Color
EY092BEG8	EY138BEG8	Beige 8oz
EY092BG8	EY138BG8	Burgundy 8oz
EY092BK8	EY138BK8	Sunstop Black 8oz
EY092BRN8	EY138BRN8	Sunstop True Brown 8oz
EY092CNV8	ET138CNV8	Sunstop Captain Navy 8oz
EY092FGR8	ET138FGR8	Sunstop Forest Green 8oz
EY092GY8	EY138GY8	Sunstop Cadet Grey 8oz
EY092JRD8	EY138JRD8	Sunstop Jockey Red 8oz
EY092LN8	EY138LN8	Sunstop Linen 8oz
EY092LRD8	EY138LRD8	Sunstop Logo Red 8oz
EY092NV8	EY138NV8	Sunstop Navy 8oz
EY092PB8	EY138PB8	Sunstop Pacific Blue 8oz
EY092SR8	EY138SR8	Sunstop Silver 8oz
EY092TS8	EY138TS8	Sunstop Toast 8oz
EY092WT8	EY138WT8	Sunstop White 8 oz

## Double Fold Bias Acrylic Binding: ¾" & 1"

- ▲ Double edge turned and glued fabric.
- ▲ Made from Sunbrella® marine fabric.
- ▲ Binding for sail covers, tents, canopies, dodgers & biminis.
- ▲ Available only on full rolls of 91.4m/100 yards.
- ▲ Finish width E098 is 19mm/ ¾ inch.
- ▲ Finish width of E097 is 25.4mm/1 inch.

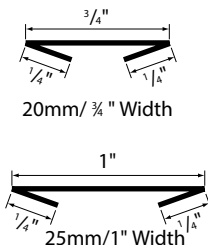

Part No. 20mm/¾" Width	Part No. 25mm/1" Width	Color
E098WT	E097WT	White
E098AQ		Aquamarine
E098ARB		Aruba
E098BAS		Basil
E098BK	E097BK	Black
E098BR	E097BR	Brass
E098BU	E097BU	Pacific Blue
E098CAP		Capri Blue
E098GY	E097GY	Cadet Gray
E098RB	E097RB	Royal Blue
E098OY	E097OY	Oyster
E098PAR	E097PAR	Parchment
E098CNV	E097CNV	Captain Navy
E098CON	E097CON	Concord
E098NV	E097NV	Navy
E098FGR	E097FGR	Forest Green
E098BG	E097BG	Burgundy
E098LT		Linen Tweed
E098RD	E097RD	Jockey Red
E098LN	E097LN	Linen
E098PSGR	E097PSGR	Persian Green
E098TST	E097TST	Toast
E098WHT		Wheat
E098BI	E097BI	Beige
E098ERGR		Erin Green
E09MARBU	E097MARBU	Marine Blue
E098MBU	E097MBU	Mediterranean Blue
E098DTD		Dubonnet Tweed
E098CCGY	E097CCGY	Charcoal Gray
E098CTWD		Charcoal Tweed
E098HTWD	E097HTWD	Hemlock Tweed
E098SR	E097SR	Silver
E098SB		Sapphire Blue
E098SGR		Sea Grass Green
E098SKBU	E097SKY	Sky Blue
E098SPA		Spa
E098LRD		Logo Red
E098MTD	E097MTD	Mediterranean Tweed
	E097WBR	Walnut Brown
E098TBR	E097TUBR	True Brown
E098TCT		Terracotta
E098TP	E097TP	Taupe
E098TQ	E097TQ	Turquoise
E098HB	E097HB	Heather Beige
E098OBU	E097OBU	Ocean Blue
E098TSTWD	E097TSTWD	Toast Tweed

## Center Fold Acrylic Binding Tape: 7/8 inch

- ▲ Woven acrylic binding tape with a naturally folding center, finished to 22.2mm/ 7/8 inch width.
- ▲ Binding for sail covers, cushions, tents, canopies, dodgers and biminis.
- ▲ Woven with Sunbrella® acrylic yarns.
- ▲ Available only on full rolls.

Actual Pattern



Part No.	Color	Width: mm/in	Roll Length: m/yd
E095BI	Beige	22.2 7/8	183 200
E095BU	Pacific Blue	22.2 7/8	183 200
E095BG	Burgundy	22.2 7/8	183 200
E095BK	Black	22.2 7/8	183 200
E095CNV	Captain Navy	22.2 7/8	183 200
E095GY	Gray	22.2 7/8	183 200
E095WT	White	22.2 7/8	183 200
E095NV	Navy Blue	22.2 7/8	183 200
E095FGR	Forest Green	22.2 7/8	183 200
E095RD	Jockey Red	22.2 7/8	183 200
E095LN	Linen	22.2 7/8	183 200
E095OYS	Oyster	22.2 7/8	183 200
E095TPE	Taupe	22.2 7/8	183 200
E095TST	Toast	22.2 7/8	183 200



Page Navigation

Thread  
Please turn to pages 116-123 for  
our range of thread products.



Note: Color representation from 4-color process is for reference purposes only. Please inquire for color sample of actual fabric.



Canvas Designers Inc, FL

## Stamoid® Single Fold Bias Binding Tape

- ▲ Super light Stamoid vinyl is bias cut with a single fold.
- ▲ Finished width 30mm/1 1/4 inch.
- ▲ Used for binding on zippers, dodgers and biminis.



30mm/1 1/4" Width

Part No.	Color	Width: mm/in	Roll Length: m/yd
E089BK	Black	30 1 1/4	91 100
E089CR	Cream	30 1 1/4	91 100
E089NV	Navy	30 1 1/4	91 100
E089SW	Snow White	30 1 1/4	91 100
E089WT	White	30 1 1/4	91 100

## Vinyl Bias Binding Tape: 3/4 inch

- ▲ "Topline" marine grade vinyl double folded bias binding tape, finished to 20mm/3/4 inch width.
- ▲ Features: Mildew treated for outdoor use, good tear and tensile strength.
- ▲ Uses: Binding for cushions, canopies, dodgers and biminis.



E075WT

E075BK

20mm/ 3/4" Width



Part No.	Color	Width: mm/in	Roll Length: m/yd
E075WT	White	20 3/4	91 100
E075BK	Black	20 3/4	91 100

## Stamoid® Vinyl Double Fold 3/4" & 1" Bias Binding Tape

- ▲ Now, premium quality Stamoid vinyl is double folded into 20mm/3/4 & 25mm 1 inch bias binding tape. Stamoid vinyl has outstanding UV resistance, is dirt repellent and washable and is waterproof and treated against mildew.
- ▲ Matching binding is used with Stamoid to trim or bind cushions, canopies, dodgers and biminis etc.
- ▲ Binding is sold in full reels only.



20mm/ 3/4" Width  
or  
25mm/1" Width



Part No. 20mm/3/4" Width	Part No. 25mm/1" Width	Color	Average Roll Length: m/yd
E085BK	E086BK	Black	91 100
E085CR	E086CR	Cream	91 100
E085GY		Grey	91 100
E085IV	E086IV	Ivory	91 100
E085RB		Royal Blue	91 100
E085SD	E086SD	Sand	91 100
E085SW	E086SW	Snow White	91 100
E085WT	E086WT	White	91 100
E085NV	E086NV	Navy	91 100

## Stamoid® Facing - 1 1/2" & 2"

- ▲ Super-light Stamoid vinyl is double folded into a finished width of 38mm/1 1/2 inch and 50mm/2 inch.
- ▲ Matching facing is used around large clear vinyl windows to save time and material.
- ▲ Facing sold in full reels only.
- ▲ 2" Ivory, Royal Blue & Sand are special order only.

38mm/1 1/2" Width  
or  
50mm/2" Width



Part No. 38mm/1 1/2"	Part No. 50mm/2"	Color	Average Roll Length: m/yd
E084BK	E083BK	Black	45.5 50
E084CR	E083CR	Cream	45.5 50
E084IV	E083IV	Ivory	45.5 50
E084NV	E083NV	Navy	45.5 50
E084RB	E083RB	Royal Blue	45.5 50
	E083SD	Sand	45.5 50
E084SW	E083SW	Snow White	45.5 50
E084WT	E083WT	White	45.5 50

## Stamoid® Light (Single Coat)

**Serge Ferrari**



- ▲ Super light weight vinyl coated woven polyester fabric comes with a 5 year limited warranty.
- ▲ **NEW:** Ivory, Snow White & White available in the new 2.6m/102" width.
- ▲ Outstanding UV resistance.
- ▲ Waterproof and treated against mildew.
- ▲ Flexible with good tensile strength.
- ▲ Uses: Console covers, spray hoods, convertible tops, camper tops, cockpit covers, bimini tops, mooring covers and many other protective applications.
- ▲ Weight: 254gsm/8.3oz/sq yd.

### Color Availability



Stamoid Light (Single Coat)

Page Navigation

**Thread**  
Please turn to pages 116-123 for our range of thread products.



Part No. 1.5m/59"	Part No. 2.03m/80"	Color	Average Roll Length: 1.5m/59" m/yd 2.03m/80"	
FH159WT	FH180WT	White	50/54.68	30/32.8
FH159IV	FH180IV	Ivory	50/54.68	30/32.8
FH159RB		Royal Blue	50/54.68	30/32.8
FH159NV		Navy Blue	50/54.68	
FH159CR		Cream	50/54.68	30/32.8
FH159GY	FH180GY	Pearl Gray	50/54.68	30/32.8
FH159SD		Sand	50/54.68	30/32.8
FH159SW	FH180SW	Snow White	50/54.68	30/32.8
FH159BK		Black	50/54.68	30/32.8
FH159SR		Silver	50/54.68	
FH159TP		Taupe	50/54.68	

Part No.	Color	Width: mm/in		Roll Length: m/yd	
FH186WT	White	2600	102	30	32.8
FH186IV	Ivory	2600	102	30	32.8
FH186NV	Navy	2600	102	30	32.8
FH186SW	Snow White	2600	102	30	32.8
FH186BK	Black	2600	102	30	32.8
FH186CHAR	Charcoal	2600	102	30	32.8
FH186CR	Cream	2600	102	30	32.8
FH186GY	Grey	2600	102	30	32.8
FH186RB	Royal Blue	2600	102	30	32.8
FH186SD	Sand	2600	102	30	32.8



### Stamoid, HD, Top, Open Care & Cleaning

Stamoid® fabric should be cleaned regularly before substances such as dirt, roof particles, etc. are allowed to accumulate on and then become embedded in the fabric.

Clean the fabric only with mild detergent solution and rinse well. Do not allow the fabric to be folded up for long periods of time when wet.

Please refer to the full cleaning instructions on the manufacturers color swatch card.

**Serge Ferrari**

Note: Color representation from 4-color process is for reference purposes only. Please inquire for color sample of actual fabric.



## Stamoid® Top (Double Coat - Heavy Duty)

**Serge Ferrari**



- ▲ Superior double coated vinyl with woven polyester fabric. 5 year limited warranty.
- ▲ Outstanding UV resistance.
- ▲ 100% waterproof and treated against mildew.
- ▲ Flexible with good tensile and tear strength.
- ▲ **NEW:** White & Snow White are now available in 2.6m/102" width.
- ▲ Uses: Console covers, spray hoods, convertible tops, camper tops, cockpit covers, bimini tops, mooring covers and many other protective applications.
- ▲ Weight: 441gsm/12.7oz/sq yd.

### Color Availability

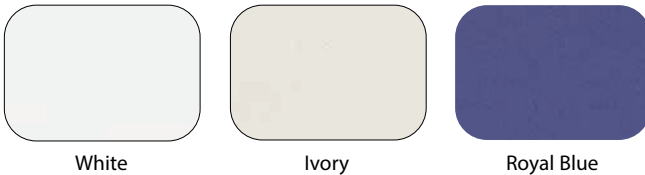

White

Ivory

Royal Blue



Cream\*

Pearl Gray

Sand

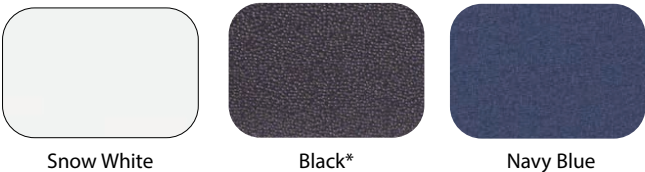

Snow White

Black\*

Navy Blue



Part No. 1.5m/59"	Part No. 2.03m/80"	Color	Average Roll Length:	
			1.5m/59" m/yd	2.03m/80"
FH259WT	FH280WT	White	50/54.68	30/32.8
FH259IV		Ivory	50/54.68	
FH259CR		Cream	50/54.68	30/32.8
FH259GY		Pearl Gray	50/54.68	
FH259NV		Navy Blue	50/54.68	
FH259SD		Sand	50/54.68	
FH259SW	FH280SW	Snow White	50/54.68	30/32.8
FH259BK		Black	50/54.68	30/32.8
FH259RB		Royal Blue	50/54.68	

Part No.	Color	Width: mm/in		Roll Length: m/yd	
FH258BK	Black	2600	102	30	32.8
FH258CR	White	2600	102	30	32.8
FH258GY	Pearl Gray	2600	102	30	32.8
FH258SD	Sand	2600	102	30	32.8
FH258WT	White	2600	102	30	32.8
FH258SW	Snow White	2600	102	30	32.8

**Serge Ferrari**

Note: Color representation from 4-color process is for reference purposes only. Please inquire for color sample of actual fabric.

Stamoid® Pure

**Serge Ferrari**



- ▲ NEW: Superior double coated vinyl/woven polyester fabric now with an oil resistant top coating to resist airborne pollutants.
- ▲ 5 year limited warranty.
- ▲ Cleans easily.
- ▲ Outstanding UV resistance.
- ▲ 100% waterproof and treated against mildew.
- ▲ Flexible with good tensile and tear strength.
- ▲ Uses: Console covers, spray hoods, convertible tops, camper tops, cockpit covers, bimini tops, mooring covers and many other protective applications.
- ▲ Weight: 441gsm/12.7oz/sq yd.

### Color Availability

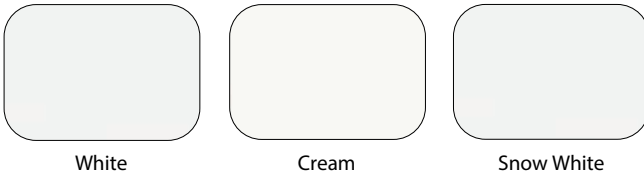

Part No.	Color	Width: mm/in		Roll Length: m/yd	
FH261WT	White	1500	59	50	54.68
FH261SW	Snow White	1500	59	50	54.68
FH261CR	Cream	1500	59	50	54.68



Stamoid® Soltis 86 - Mesh

# SOLTIS

- ▲ Premium vinyl coated, 1100 dtex polyester mesh.
- ▲ Excellent tensile and tear strength.
- ▲ Uses: Wind & sun screens, privacy curtains and shade awnings to eliminate approximately 86% of the sun's rays.
- ▲ Width: Standard 1770mm/70". Black\* also in 2667mm/105".
- ▲ Weight: 11.2oz sq yd / 380gsm.

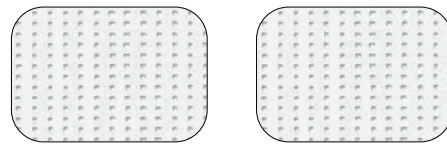

Bronze Sandy Beige

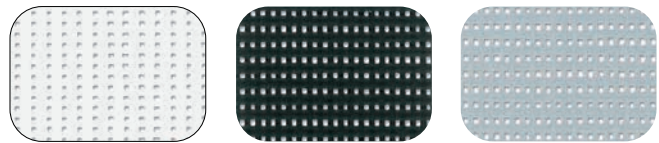

White Black\* Boulder

Part No.	Color	Width: mm/in		Roll Length: m/yd	
FH286WT	White	1770	70	50	54
FH286BK	Black	1770	70	50	54
FH286BR	Bronze	1770	70	50	54
FH286GY	Boulder	1770	70	50	54
FH286SBG	Sandy Beige	1770	70	50	54

Part No.	Color	Width: mm/in		Roll Length: m/yd	
FH287BK	Black Only*	2667	105	40	43

Page Navigation

Mesh Fabrics  
Please turn to pages 44-47 for  
our range of other mesh fabrics.



Note: Color representation from 4-color process is for reference purposes only. Please inquire for color sample of actual fabric.

Strength from within.



Though not always visible to the eye, **inner strength prevails.**

Constructed to perform and stay beautiful longer, Serge Ferrari's innovative and patented **Preconstraint® technology** tensions the woven yarns in both warp and weft directions prior to coating. The result is a flatter basecloth that ensures a thicker, more consistent protective coating.

While not always evident at first touch or glance, the strength of a material and its longevity lies in how it's built, its inner core strength.

**If you can dream it, we can cover it.**



*Greater protection from a more compact fabric*

**Serge Ferrari**  
marketing.us@sergeferrari.com  
sergeferrari.com/us  
Twitter Facebook LinkedIn Instagram

## Bainbridge Santa Cruz Marine Cover Fabric



- ▲ 100% pigmented vinyl coated polyester cover fabric with a white underside.
- ▲ Applications: Ideal for trailer & mooring covers, pontoon boats, campers etc.
- ▲ Weight: 315gsm /9.3oz/sq yd .
- ▲ Five year limited warranty.

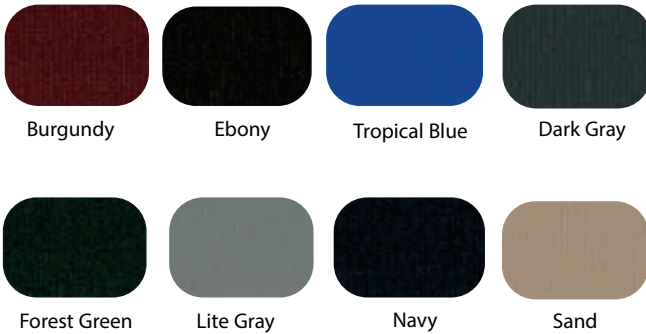

Part No.	Color	Width: mm/in	Roll Length: m/yd
FH640BG	Burgundy	1520 60	59 65
FH640BK	Ebony	1520 60	59 65
FH640BU	Tropical Blue	1520 60	59 65
FH640DGY	Dark Gray	1520 60	59 65
FH640FGR	Forest Green	1520 60	59 65
FH640LGY	Lite Gray	1520 60	59 65
FH640NV	Navy	1520 60	59 65
FH640SD	Sand	1520 60	59 65



### Care & Cleaning of Vinyl

Vinyl fabrics should be cleaned regularly before substances such as dirt, roof particles, etc. are allowed to accumulate. Clean the fabric only with mild detergent solution and rinse well.

Please refer to the full cleaning instructions on the manufacturers color swatch card.



## Weblon - Regatta Yacht Fabric



Polyester laminated vinyl with Rain Kleen finish.

- ▲ 5 year warranty.
- ▲ Pastel lining relieves glare.
- ▲ Resists tears and abrasion.
- ▲ Easy to clean and store.
- ▲ Waterproof and mildew resistant.
- ▲ Uses: boat tops, bimini covers.
- ▲ Weight 475gsm/13oz/sq yd.

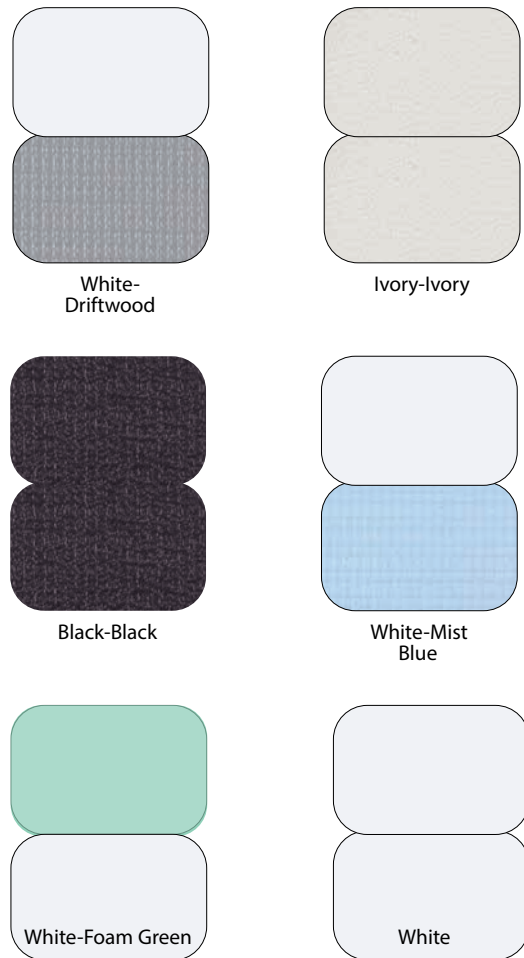

Part No.	Color	Width: mm/in	Roll Length: m/yd
FH462DW	White-Driftwood	1570 62	45.7 50
FH462II	Ivory-Ivory	1570 62	45.7 50
FH462BK	Black-Black	1570 62	45.7 50
FH462WB	White-Mist Blue	1570 62	45.7 50
FH462WFG	White-Foam Green	1570 62	45.7 50
FH462WW	White	1570 62	45.7 50

Note: Color representation from 4-color process is for reference purposes only. Please inquire for color sample of actual fabric.

## CoverFlex - Non Woven Cover Fabric

- ▲ Soft Hand
- ▲ Multi Layers of: Polypropylene/Polyethylene/Polyester
- ▲ Breathable
- ▲ UV Resistant
- ▲ Roll Length: 70yds/64m
- ▲ Width: 63"/1600mm
- ▲ Grey Variegated Top with a White Underside

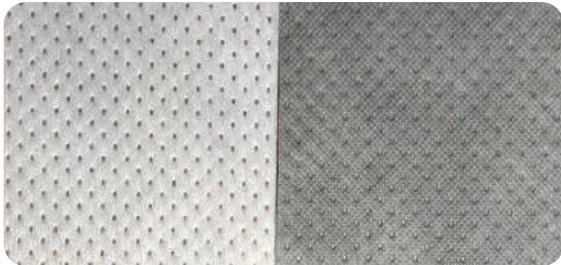

Part No.	Color	Width: mm/in		Av Roll Length: m/yd	
F0255A97Y	Translucent	1600	63	64	70

CoverFlex replaces Evolution 4 as that product is no longer available.



Page Navigation

Please turn to pages 28-34 for more information on polyester marine fabrics from Marlen Textiles.



Note: Color representation from 4-color process is for reference purposes only. Please inquire for color sample of actual fabric.

## Bainbridge Cover Cloth



- ▲ Woven polyester with a silicone water repellent finish.
- ▲ Uses: Splash curtains, mooring covers, enclosures, side panels.

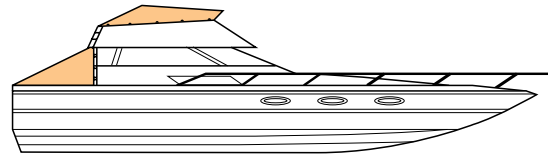
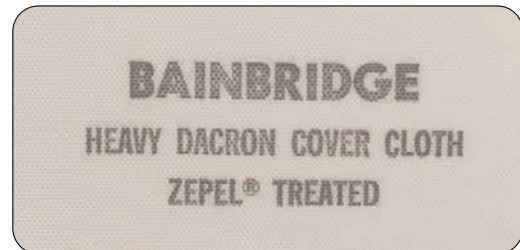

Part No.	Style	Weight: gsm/oz sq yd		Width: mm/in		Av Roll Length: m/yd	
F2610G00M	Fleetboat	197	5.8	1370	54	92	100
F2630G00M	Heavy	302	8.9	1370	54	92	100

## Marine Topping

- ▲ Vinyl laminated with denim 50% Poly/50% Cotton backing.
- ▲ Features: UV and mildew resistant, high tear & tensile strength, waterproof/rot resistant, easy to clean, stable.
- ▲ Uses: convertible tops, boom tents, dodgers, side and aft curtains, mooring covers, hatch covers, equipment covers and many other protective applications.
- ▲ Sold In Full Rolls Only.
- ▲ Weight: 543 gsm/16oz sq yd.



Part No.	Color	Weight: gsm/oz/sq yd		Width: mm/in		Av Roll Length: m/yd	
FH153WT	Sea White/Denim	543	16	1530	60	55	60

## Top Gun Polyester Cover Cloth



- ▲ 100% woven 600d Polyester fabric with a specially formulated polymeric coating that will not harden, crack or peel after outdoor exposure or when subjected to temperatures below 0°F.
- ▲ Water repellent, permeable to water vapour but will not trap excess moisture.
- ▲ Stable fabric with maximum stretch or shrinkage less than 1%.
- ▲ Super high strength with great abrasion resistance.
- ▲ UV and mildew resistant.
- ▲ 5 year limited warranty.
- ▲ Uses: Biminis, tops, trailer covers, winter covers.
- ▲ Weight: 373gsm/11.5oz sq yd.

## Marlen Textiles

Polyester Fabrics - Top Gun



Chocolate



Caribbean



Seagull Gray



Navy Blue



Taupe

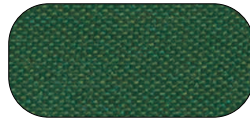

Forest Green



Aquamarine



Onyx Black\*



Burgundy



Indian Birch



Arctic White



Teal



Buckskin Tan



Harbor Blue



Sand



Royal Blue



Charcoal Gray



Turquoise



Sunset Red



Hemp Beige

Part No.	Color	Width: mm/in		Av Roll Length: m/yd	
F0300A18Y	Caribbean Blue - 463	1570	62	45.7	50
F0300A97Y	Seagull Gray - 467	1570	62	45.7	50
F0300A22Y	Navy Blue - 474	1570	62	45.7	50
F0300A46Y	Forest Green - 479	1570	62	45.7	50
F0300A89Y	Aquamarine - 462	1570	62	45.7	50
F0300A60Y	Onyx Black - 471	1570	62	45.7	50
F0300A14Y	Indian Birch - 472	1570	62	45.7	50
F0300A00Y	Arctic White - 468	1570	62	45.7	50
F0300A44Y	Teal - 478	1570	62	45.7	50
F0300A75Y	Burgundy - 476	1570	62	45.7	50
F0300A10Y	Sunset Red - 477	1570	62	45.7	50
F0300A67Y	Hemp Beige - 465	1570	62	45.7	50
F0300A74Y	Buckskin Tan - 470	1570	62	45.7	50
F0300A90Y	Harbor Blue - 473	1570	62	45.7	50
F0300A98Y	Charcoal Gray - 458	1570	62	45.7	50
F0300A66Y	Sand - 461	1570	62	45.7	50
F0300A79Y	Royal Blue - 464	1570	62	45.7	50
F0300A85Y	Turquoise - 466	1570	62	45.7	50
F0300A65Y	Taupe - 459	1570	62	45.7	50
F0300A68Y	Chocolate Brown - 469	1570	62	45.7	50



F0308A60W	*Onyx Black 80" - 471	2030	80	45.7	50
F0308A97W	Sea Gull Gray 80" - 467	2030	80	45.7	50

Note: Color representation from 4-color process is for reference purposes only. Please inquire for color sample of actual fabric.

Top Gun 9 - Polyester Cover Cloth



- ▲ Acrylic coated, woven 450 denier polyester greige goods.
- ▲ Formerly known as Mustang.
- ▲ Dimensionally stable with exceptional tensile & tear strength.
- ▲ Durable - will not crack or delaminate.
- ▲ Excellent water resistance, so no worries about leaking.
- ▲ Weight: 305 gsm/9.0 oz sq yd.
- ▲ New Top Gun 9 is lighter than Top Gun but heavier than Odyssey.

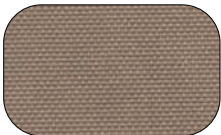

Hemp Beige

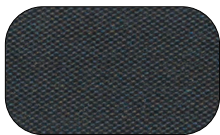

Black



Sea Gull Gray



Forest Green



Sand

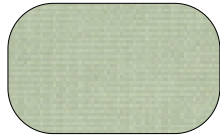

Indian Birch



Chocolate Brown



Charcoal



Caribbean Blue



Burgundy



Royal Blue



Arctic White



Navy Blue



Taupe

# Marlen Textiles

## Care & Cleaning of Fabrics

Cover fabrics should be cleaned regularly before substances such as dirt, roof particles, etc. are allowed to accumulate. Clean the fabric only with mild detergent solution and rinse well.

Please refer to the full cleaning instructions on the manufacturers color swatch card.



### Page Navigation

Please turn to pages 59 for more information on new Top Gun FR (Flame Retardent)



Part No.	Color	Width: mm/in		Length: m/yd	
F0550A47Y	Forest Green - 879	1570	62	45.7	50
F0550A79Y	Royal Blue - 864	1570	62	45.7	50
F0550A18Y	Caribbean Blue - 863	1570	62	45.7	50
F0550A67Y	Hemp Beige - 865	1570	62	45.7	50
F0550A60Y	Onyx Black - 871	1570	62	45.7	50
F0550A62Y	Chocolate Brown - 869	1570	62	45.7	50
F0550A65Y	Taupe - 859	1570	62	45.7	50
F0550A66Y	Sand - 861	1570	62	45.7	50
F0550A97Y	Sea Gull Gray - 867	1570	62	45.7	50
F0550A98Y	Charcoal - 858	1570	62	45.7	50
F0550A14Y	Birch - 872	1570	62	45.7	50
F0550A22Y	Navy - 874	1570	62	45.7	50
F0550A75Y	Burgundy - 876	1570	62	45.7	50
F0550A00Y	White - 868	1520	62	45.7	50

Note: Color representation from 4-color process is for reference purposes only. Please inquire for color sample of actual fabric.

## Odyssey Polyester Cover Cloth

# Odyssey

- ▲ Acrylic coated 100% woven 300d Polyester with a clear back coat. Suitable many indoor or outdoor applications.
- ▲ Previously known as Odyssey III.
- ▲ Mildew and UV resistant.
- ▲ Superior water and stain resistance.
- ▲ Very low shrink or stretch.
- ▲ Uses: Cots, boat covers, canopies, bags & covers.
- ▲ Weight: 220gsm/6.5oz sq yd.



Caribbean



Silver Gray



Birch

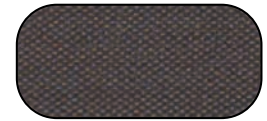

Teal



Royal Blue



White



Teal



Forest Green

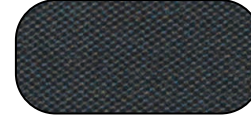

Black



Red

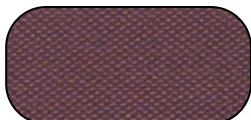

Burgundy



Turquoise



Harbor Blue



Taupe



Charcoal Gray



Sand



Brown



Lakeside Blue

## Marlen Textiles



Part No.	Color	Width: mm/in		Av Roll Length: m/yd	
F0800A18Y	Caribbean Blue - 494	1630	64	68.6	75
F0800A88Y	Silver Gray - 489	1630	64	68.6	75
F0800A79Y	Royal Blue - 480	1630	64	68.6	75
F0800A00Y	White - 487	1630	64	68.6	75
F0800A10Y	Red - 483	1630	64	68.6	75
F0800A14Y	Birch - 499	1630	64	68.6	75
F0800A44Y	Teal - 490	1630	64	68.6	75
F0800A46Y	Forest Green - 488	1630	64	68.6	75
F0800A60Y	Black - 449	1630	64	68.6	75
F0800A75Y	Burgundy - 496	1630	64	68.6	75
F0800A85Y	Turquoise - 497	1630	64	68.6	75
F0800A90Y	Harbor Blue - 498	1630	64	68.6	75
F0800A97Y	Charcoal Gray - 492	1630	64	68.6	75
F0800A41Y	Aquamarine - 484	1630	64	68.6	75
F0800A20Y	Lakeside Blue - 493	1630	64	68.6	75
F0800A62Y	Brown - 491	1630	64	68.6	75
F0800A66Y	Sand - 426	1630	64	68.6	75
F0800A65Y	Taupe - 408	1630	64	68.6	75

Note: Color representation from 4-color process is for reference purposes only. Please inquire for color sample of actual fabric.



Soft Touch by Odyssey

# Softouch®

- ▲ 100% woven, acrylic coated polyester Odyssey with a light weight, non-woven, soft fuzzy polyester backing.
- ▲ Abrasion resistant.
- ▲ Weatherproof.
- ▲ Backing provides excellent gel-coat or varnish protection.
- ▲ Uses: boat & trailer covers.
- ▲ Weight: 405gsm/12.5oz sq yd.



Part No.	Color	Width: mm/in		Av Roll Length: m/yd	
F0805A18Y	Caribbean Blue - 994	1520	60	45.7	50
F0805A88Y	Silver Grey - 989	1520	60	45.7	50
F0805A60Y	Black - 949	1520	60	45.7	50
F0805A65Y	Taupe - 908	1520	60	45.7	50
F0805A75Y	Burgundy - 996	1520	60	45.7	50
F0805A00Y	White - 987	1520	60	45.7	50
F0805A79Y	Royal Blue - 980	1520	60	45.7	50
F0805A97Y	Charcoal Gray - 992	1520	60	45.7	50
F0805A90Y	Harbor Blue - 998	1520	60	45.7	50



Caribbean



Silver Gray

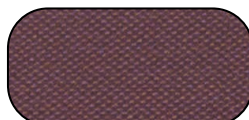

Burgundy

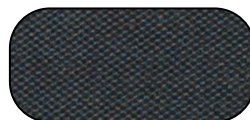

Black



Charcoal



Taupe

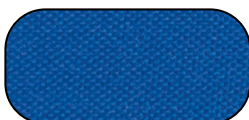

Royal Blue



Harbor Blue

Odyssey PSA Polyester Cover Cloth

# Odyssey PSA

- ▲ 100% woven, acrylic coated polyester Odyssey, suitable for many indoor or outdoor applications.
- ▲ Mildew and UV resistant.
- ▲ Superior water and stain resistance.
- ▲ Very low shrink or stretch.
- ▲ Pressure sensitive adhesive backing.

Part No.	Color	Width: mm/in		Av Roll Length: m/yd	
F0808Z18Y	Caribbean Blue - 494	1520	60	45.7	50
F0808Z88Y	Silver Grey - 989	1520	60	45.7	50
F0808Z00Y	White - 987	1520	60	45.7	50
F0808Z79Y	Royal Blue - 980	1520	60	45.7	50
F0808Z97Y	Charcoal Gray - 992	1520	60	45.7	50
F0808Z90Y	Harbor Blue - 998	1520	60	45.7	50



Royal Blue



White



Charcoal Gray



Harbour Blue



Caribbean



Silver Gray

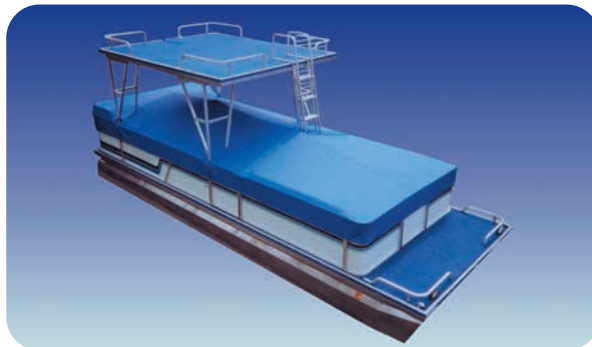

Odyssey FR Polyester Cover Cloth

# Odyssey FR



- ▲ FR 100% woven polyester - acrylic coated.
- ▲ Meets CPAI-84 & NFPA-701. Ideal for canopies, awnings etc.

Part No.	Color	Width: mm/in		Av Roll Length: m/yd	
F0840A00Y	White Only	1630	64	68.6	75

Note: Color representation from 4-color process is for reference purposes only. Please inquire for color sample of actual fabric.

## Top Notch - Solution Dyed Polyester



- ▲ Solution dyed 840d polyester - colorfast & UV resistant.
- ▲ Dimensionally stable and exceptional tear strength.
- ▲ Durable and abrasion resistant finish.
- ▲ Fluorocarbon finish for excellent water repellancy.
- ▲ 5 year warranty.
- ▲ Weight: 373gsm/11.5oz sq yd.



Commander Navy



Burgundy

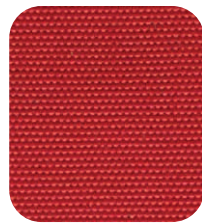

Red



Blue



Forest Green

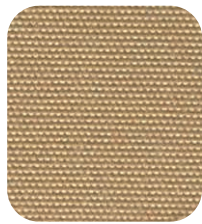

Tan



Taupe



Charcoal



Black



Pacific Blue

Part No.	Color	Width: mm/in	Length: m/yd
F0200A00Y	White	1520 60	45.7 50
F0200A10Y	Red - 577	1520 60	45.7 50
F0200A46Y	Forest Green - 579	1520 60	45.7 50
F0200A60Y	Black - 571	1520 60	45.7 50
F0200A97Y	Silver Gray - 567	1520 60	45.7 50
F0200A18Y	Blue - 563	1520 60	45.7 50
F0200A22Y	Pacific Blue - 594	1520 60	45.7 50
F0200A23Y	Commander Navy - 574	1520 60	45.7 50
F0200A65Y	Taupe - 559	1520 60	45.7 50
F0200A67Y	Tan - 570	1520 60	45.7 50
F0200A75Y	Burgundy - 576	1520 60	45.7 50
F0200A98Y	Charcoal - 558	1520 60	45.7 50



White



Silver Gray

Page Navigation

Please turn to pages 29 for more information on care & cleaning fabrics from Marlen Textiles



# Marlen Textiles

Note: Color representation from 4-color process is for reference purposes only. Please inquire for color sample of actual fabric.

Top Notch 9 - Solution Dyed Polyester



- ▲ Solution dyed polyester - colorfast & UV resistant.
- ▲ Previously known as Top Notch Elite.
- ▲ Excellent tear & tensile strength.
- ▲ Breathable & water repellent.
- ▲ 5 year warranty
- ▲ Weight: 305gsm/9.0oz sq yd.



Top Notch 1S - Solution Dyed Polyester



- ▲ Solution dyed polyester - colorfast & UV resistant.
- ▲ Previously known as Vista.
- ▲ Clear back coating - water resistant.
- ▲ Excellent tear & tensile strength.
- ▲ 5 year warranty
- ▲ Weight: 255gsm/7.5oz sq yd.



Black\*



Forest Green



White



Caribbean Blue



Tan

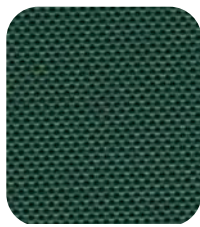

Charcoal

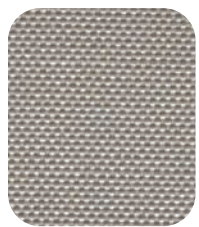

Silver Gray



Admiral Navy

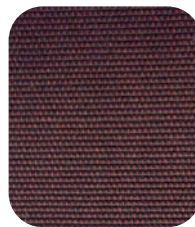

Burgundy Weave

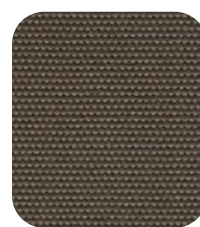

Taupe

Top Notch 9

Part No.	Color	Width:		Length:	
		mm/in		m/yd	
F0700A98Y	Charcoal - 2692	1520	60	45.7	50
F0700A46Y	Forest Green - 2688	1520	60	45.7	50
F0700A60Y	Black - 2649	1520	60	45.7	50
F0700A97Y	Silver Gray - 2648	1520	60	45.7	50
F0700A18Y	Caribbean Blue - 2694	1520	60	45.7	50
F0700A66Y	Tan - 2642	1520	60	45.7	50
F0700A23Y	Admiral Navy - 2674	1520	60	45.7	50
F0700A77Y	Burgundy Weave - 2609	1520	60	45.7	50
F0700A00Y	White - 2687	1520	60	45.7	50
F0700A65Y	Taupe - 2608	1520	60	45.7	50
F0700A66Y	Tan - 2642	1520	60	45.7	50



Marlen Textiles

Note: Color representation from 4-color process is for reference purposes only. Please inquire for color sample of actual fabric.

NO MATTER YOUR APPLICATION



WE'VE GOT YOU COVERED

**Marlen Textiles**

**TOP NOTCH** **TOP GUN**

**Odyssey** **Softouch**<sup>®</sup>

[www.marlentextiles.com](http://www.marlentextiles.com)

## Stainless Steel Bolster Clip

- ▲ Attaches bolster cushions to cockpit.
- ▲ Premium 316 stainless steel.
- ▲ 1/4" Offset
- ▲ Size: 3/4"/19mm x 2 1/4"/56mm



Not To Scale

Part No.	Description
G228S	Stainless Steel Bolster Clip
G235SSET	Stainless Coaming/Bolster Pad Hook & Eye Set

## Rigid Hook Washer

- ▲ Screws or glues onto hull. Attaches to seats, cushions, velcro or loop products.
- ▲ Washer could replace many adhesive backed hook fasteners.
- ▲ Available only in White.
- ▲ Sold in packs of 25 pieces only.



45mm Diameter

Part No.	Length: mm/in	Color	Pack Quantity
E714WT	45 1 3/4"	White Only	25

## T-Nuts - Stainless Steel

- ▲ Marine grade type 302 stainless steel
- ▲ Sold in packs of 25 pieces.
- ▲ Thread: 1/4" x 20
- ▲ Barrel: 3/8"
- ▲ Flange: 3/4"
- ▲ Thickness: 0.042



Part No.	Description	Pack Quantity
G246S	Stainless Steel Tee Nut - 1/4" x 20 x 3/8" barrel	25

## Welt Cord

- ▲ 5/32" Foam welt cord is very flexible - ideal for tight cushion corners etc. Does not rot or mildew.
- ▲ 1/4" Polyethylene hollow core tube is ideal for making custom color awning cord. Does not rot or mildew.



Part No.	Color	Diameter: mm/in	Av Roll Length: M/Yds
E390	White	3.97 5/32"	457 500
E494	White	6.35 1/4"	304 333.3

## Pneumatic Upholstery Staple Gun

- ▲ Ergonomic handle and rubber grip.
- ▲ Bottom loading magazine aides speed of reloading.
- ▲ Two finger trigger.
- ▲ Rear exhaust with muffler.
- ▲ Applications: Marine & automotive upholstery, Bedding, Molding.



Part No.	Description
C754	Heavy Duty Empire Pneumatic Upholstery Staple Gun

## Upholstery Staples - Stainless Steel

- ▲ Specifically for the pneumatic staple gun.
- ▲ Sold in boxes of 10,000 pieces.
- ▲ Stainless Steel.
- ▲ #7 - 1/4", 3/8" & 1/2" sizes.



Part No.	Description
D744	Stainless Steel #7 Upholstery Staples 1/4"
D748	Stainless Steel #7 Upholstery Staples 3/8"
D742	Stainless Steel #7 Upholstery Staples 1/2"

## Staple Remover



Part No.	Description
C519	Metal Push-Type Staple Remover

## Ultraleather®

Ultraleather fabrics have the look and feel of the finest European calfskin, engineered for better performance.

- ▲ Ultraleather is not a PVC (Vinyl) but is an advanced polyurethane product.
- ▲ Easy to clean, washable with soap & water.
- ▲ Scratch, nick and blemish resistant.
- ▲ Resists cracking, crocking and peeling.
- ▲ Will not stiffen in cold or feel sticky in heat.
- ▲ Excellent color fastness.
- ▲ Environment-friendly. No plasticizers or formaldehyde.
- ▲ Weight: 315gsm/9.3oz sq yd.

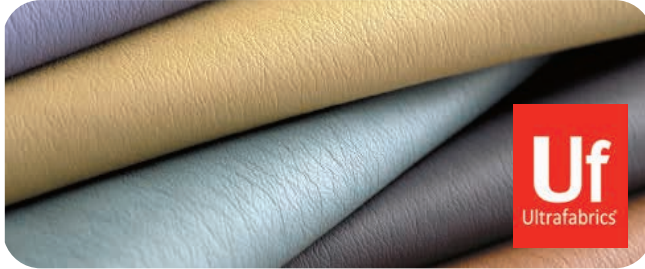

Part No.	Color	Width: mm/in	Length: m/yd
FL291-0000	Ultraleather Range	1370 54	27 30

## Ultraleather Plus®

- ▲ Anti-microbial - shields bacterial growth.
- ▲ Meets CA 117e, NFPA 260, ASTM E 84.
- ▲ Please see color card for full range of colors.
- ▲ Weight: 420gsm/12.4 oz sq yd.



Part No.	Color	Width: mm/in	Length: m/yd
FL398-0000	Ultraleather Plus Range	1370 54	27 30

## Ultraleather Promessa®

- ▲ Realistic and distinctive grain pattern taken from those found in nature.
- ▲ Resists UV/mildew/rot/atmospheric chemicals.
- ▲ Meets CA 117e, NFPA 260 & ASTM E 84.
- ▲ Please see color card for full range of colors.



Part No.	Color	Width: mm/in	Length: m/yd
FL363-0000	Promessa Range	1370 54	27 30

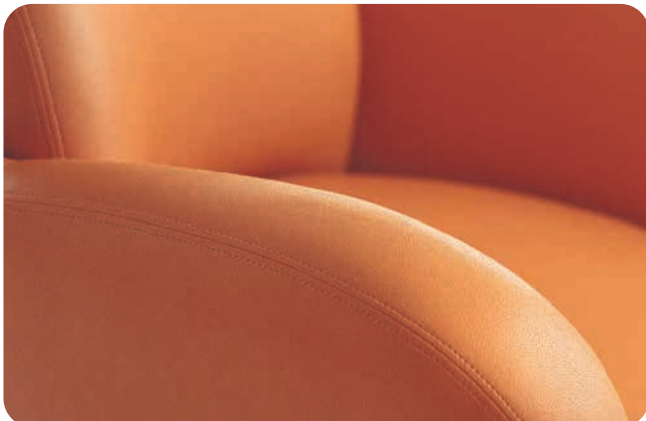

## Ultraleather Brisa®

- ▲ One of the most popular fabrics in the range.
- ▲ Meets CA 117e, NFPA 260 and ASTM E 84.
- ▲ Please see color card for full range of colors
- ▲ Weight: 312gsm/9.2 oz sq yd.



Part No.	Color	Width: mm/in	Length: m/yd
FL303-0000	Brisa Range	1370 54	27 30



## Ultraleather Brisa Distressed®

- ▲ Part of the lifestyle collection, with a unique distressed pattern.
- ▲ Please see color card for full range of colors.
- ▲ Weight: 312gsm/9.2 oz sq yd.



Part No.	Color	Width: mm/in	Length: m/yd
FL335-0000	Brisa Distressed Range	1370 54	27 30

## Ultraleather Brisa Outdoor®

Brisa High UV can traverse between indoor and outdoor use as it addresses the unique requirements of extreme light installations.

- ▲ Breathable Technology.
- ▲ Solar endurance resists fading.
- ▲ Mildew resistant.
- ▲ Please see swatch card for full range of colors.
- ▲ Weight: 326gsm/9.6 oz sq yd.



Part No.	Color	Width: mm/in	Length: m/yd
FL393-0000	Brisa Outdoor Range	1370 54	27 30

- Clean regularly with soap and water
- Wipe up spills as soon as they occur
- Lift most stains with alcohol based cleaner
- Disinfect using a 5:1 water/bleach solution
- Rinse off cleaning solution with water - air dry



Note: Color representation from 4-color process is for reference purposes only. Please inquire for color sample of actual fabric.

### Ultrasuede® Ambiance

- ▲ Soft, plush suede hand.
- ▲ Meets FR codes: CA 117 Class 1, ASTM E84 Class A.
- ▲ Excellent colorfastness.
- ▲ Spot-cleanable and washable.
- ▲ 100% polyester microfiber.
- ▲ Uses: Upholstery, wallcoverings etc.
- ▲ Weight: 376 gsm / 11.1oz sq yd.



ultrasuede®  
Ambiance



Part No.	Color	Width: mm/in		Length: m/yd	
FA862-0000	Ambiance Range	1397	55	30	33

### Sensuede®

Superior quality man-made suede, ideal for upholstery and interior applications.

- ▲ Sensuede is resistant to fade.
- ▲ Easy to clean, washable.
- ▲ 88% polyester and 12% polyurethane.
- ▲ Flammability passes Calif Bulletin 117, NFPA-260.
- ▲ Excellent color fastness.
- ▲ Easy to sew, hold a stitch.
- ▲ Weight: 275gsm/13.2 oz lin. yd.



imagine it in  
sensuede



Part No.	Description	Width: mm/in		Roll Length: m/yd	
FSSENS/****	Sensuede	1420	56	30	33

### Sunbrella® - Furniture Grade



- ▲ A lighter weight version of Sunbrella's 100% solution dyed acrylic fabric. See the color card for full range of available styles and colors.
- ▲ Resists UV, mildew, rot and atmospheric chemicals.
- ▲ Limited 2 or 3 year warranty.
- ▲ Colors available to special order.
- ▲ Weight: 271gsm/8oz sq yd.



Part No.	Width: mm/in		Roll Length: m/yd	
FURNITURE	1370	54	32 - 50	35 - 55



Note: Color representation from 4-color process is for reference purposes only. Please inquire for color sample of actual fabric.

## Seabrook - Marine Upholstery

- ▲ Premium UV protected marine grade vinyl upholstery fabric.
- ▲ Leather like feel.
- ▲ Special backing allows for easier tailorability.
- ▲ Excellent durability.
- ▲ Designed to meet California Flammability Reg. 117; Section E.
- ▲ Mildew resistant and UV stabilized.
- ▲ Passes 1000 hour weather meter.
- ▲ Weight: 725gsm/31oz per linear yard.



**Morbern**



Part No.	Color	Width: mm/in		Av Roll Length: m/yd	
F0960A008	Chalk White	1370	54	36.6	40
F0960A048	Sea White	1370	54	36.6	40
F0960A068	Stinger Cream	1370	54	36.6	40
F0960A088	Stinger Bisque	1370	54	36.6	40
F0960A108	American Beauty	1370	54	36.6	40
F0960A138	Ruby	1370	54	36.6	40
F0960A158	Blue	1370	54	36.6	40
F0960A228	Midnight Blue	1370	54	36.6	40
F0960A358	Marigold	1370	54	36.6	40
F0960A428	Lime	1370	54	36.6	40
F0960A468	Forest Green	1370	54	36.6	40
F0960A518	Lite Glacier	1370	54	36.6	40
F0960A528	Moonlite Gray	1370	54	36.6	40
F0960A538	Marble Gray	1370	54	36.6	40
F0960A568	Porcelain	1370	54	36.6	40
F0960A998	Ebony	1370	54	36.6	40

## Seabrook - Dull/Matte Marine Upholstery Vinyl

Part No.	Color	Width: mm/in		Av Roll Length: m/yd	
F0963A008	D - Chalk White	1370	54	36.6	40
F0963A048	D - Sea White	1370	54	36.6	40
F0963A038	D - Gel White	1370	54	36.6	40
F0963A078	D - Sea Shell	1370	54	36.6	40
F0963A488	D - Nu Teal	1370	54	36.6	40
F0963A548	D - Purple	1370	54	36.6	40
F0963A558	D - Hot Orange	1370	54	36.6	40

Seabrook marine upholstery vinyl is now available in channel.



## Seabrook - Quilted Vinyl 1 1/2" Channel

- ▲ UV protected marine grade vinyl upholstery fabric.
- ▲ Quilted channel is 38mm/1 1/2" width spacing.
- ▲ 52" useable width.
- ▲ Weight: 916gsm/40.5oz per linear yard.

**Morbern**



Part No.	Color	Width: mm/in		Av Roll Length: m/yd	
F0960C008	Chalk White	1320	52	18.3	20
F0960C048	Sea White	1320	52	18.3	20
F0960C068	Stinger Cream	1320	52	18.3	20
F0960C088	Stinger Bisque	1320	52	18.3	20
F0960C228	Midnight Blue	1320	52	18.3	20
F0960C468	Forest Green	1320	52	18.3	20
F0960C518	Lite Glacier	1320	52	18.3	20
F0960C538	Marble	1320	52	18.3	20
F0960C528	Moonlite Gray	1320	52	18.3	20

## Seabrook - Dull/Matte Quilt Vinyl Channel

Part No.	Color	Width: mm/in		Av Roll Length: m/yd	
F0963C008	Quilt D - Chalk White	1370	52	18.3	20
F0963C048	Quilt D - Sea White	1370	52	18.3	20
F0963C058	Quilt D - Gel White	1370	52	18.3	20
F0963C078	Quilt D - Sea Shell	1370	52	18.3	20

## Seabrook Hidem Gimp

- ▲ Hidem gimp is made from Seabrook vinyl - folded & sewn.
- ▲ Used to hide staples or tacks and serves as a binding.
- ▲ Use with Seabrook marine vinyl & quilted channel fabrics.
- ▲ Available in most colors.

**Morbern**



Part No.	Color	Width: mm/in		Av Roll Length: m/yd	
LS613CK	Chalk White	15	5/8	22.8	25
LS613DGWT	Dull Gel White	15	5/8	22.8	25
LS613DSWT	Dull Sea White	15	5/8	22.8	25
LS613DWT	Dull White	15	5/8	22.8	25
LS613BK	Ebony Black	15	5/8	22.8	25
LS613LGL	Light Glacier	15	5/8	22.8	25
LS613ML	Moonlight	15	5/8	22.8	25
LS613PN	Porcelain	15	5/8	22.8	25
LS613SC	Stinger Cream	15	5/8	22.8	25
LS613SW	Sea White	15	5/8	22.8	25

Note: Color representation from 4-color process is for reference purposes only. Please inquire for color sample of actual fabric.



## Seabrook Welt

- ▲ 5/32" Welt is made from Seabrook vinyl.
- ▲ Use with Seabrook marine vinyl fabrics.
- ▲ Sold in full 50 yard reels only.
- ▲ Available in many colors - call for details.



Part No.	Color	Width: mm/in	Av Roll Length: m/yd
LS622CK	Chalk White	- -	45.7 50
LS622GEL	Gel White	- -	45.7 50
LS622ML	Moonlight	- -	45.7 50
LS622BK	Ebony Black	- -	45.7 50

## Cantech Upholstery Vinyl

- ▲ Unique marine grade upholstery vinyl.
- ▲ Perfect match for Cantech gel coat color.
- ▲ Weight: approx. 725gsm/21oz sq. yd or 915gsm/27oz sq. yd for channel.
- ▲ Channel is quilted at 25mm/1" spacing.



Part No.	Style	Width: mm/in	Av Roll Length: m/yd
F0965A008	Cantech White	1370 54	36.6 40

## Cantech Quilted Vinyl - 1" Channel

Part No.	Style	Width: mm/in	Av Roll Length: m/yd
F0965C008	Cantech White Channel	1320 52	18.3 20

## Marine Hull Liner

- ▲ Very durable carpet material for use inside boat hulls.
- ▲ Geometric pattern with raised bumps. Can also be used as headliner & wallcovering in RV's etc.
- ▲ Mold & mildew resistant.
- ▲ Easy to cut and fit to desired shape.
- ▲ Meets FMVSS 302 FR rating.
- ▲ Weight 509gsm/15oz sq yd.



Cream

Sand

Silver

Part No.	Style	Width: mm/in	Av Roll Length: m/yd
FH435CR	Hull Liner - Cream	1830 72	45.7 50
FH435SD	Hull Liner - Sand	1830 72	45.7 50
FH435SVR	Hull Liner - Silver	1830 72	45.7 50

## Marine Headliner

- ▲ Marine grade UV protected vinyl.
- ▲ Apply with adhesives.
- ▲ Available with standard vinyl or vinyl laminated to 6.4mm/ 1/4" clickable foam.
- ▲ Available in perforated or flat styles.

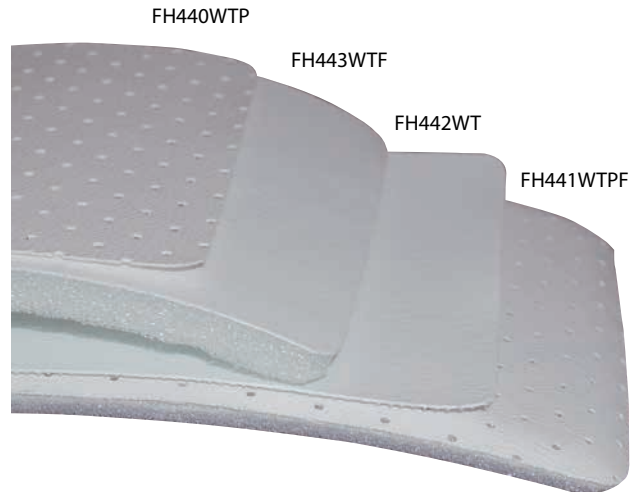

## Headliner - White Perforated Vinyl

Part No.	Style	Width: mm/in	Av Roll Length: m/yd
FH440WTP	Plain Perforated - 13.9oz	1370 54	45.7 50
FH441WTPF	1/4" Foam Perforated -14.oz	1370 54	22.8 25
FH449WTP	Plain Perforated - 8.6oz	1370 54	45.7 50

## Headliner - White Flat Vinyl

Part No.	Style	Width: mm/in	Av Roll Length: m/yd
FH442WT	Plain - 8.9oz	1370 54	45.7 50
FH443WTF	1/4" Foam - 16.5oz	1370 54	22.8 25

## Underlining

- ▲ Lightweight vinyl coated polyester fabric designed for bottom side of cushions, seats and upholstery to let water drain out and air to circulate.
- ▲ Weight 305gsm/9oz sq yd.
- ▲ Breathes to release moisture, and resist rot and mildew.

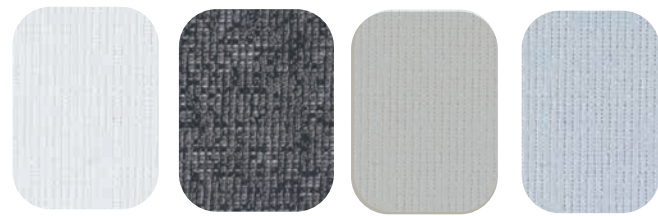

White

Black

Beige

Gray

Part No.	Color	Width: mm/in	Av Roll Length: m/yd
FH456WT	White	1370 54	91.4 75
FH456BK	Black	1370 54	91.4 75
FH456GY	Gray	1370 54	91.4 75
FH456BEG	Beige	1370 54	91.4 75

## Nautolex Vinyl Range



- ▲ Premium UV protected marine grade expanded vinyl upholstery fabric.
- ▲ Designed to meet CA. FR 117-75, Sec.E.
- ▲ Excellent tear strength.
- ▲ Products with Prefix have outstanding stain resistance and cleanability.
- ▲ Superior abrasion resistance.
- ▲ Mildew resistant.

### Capitano

- ▲ Smooth emboss, semi-dull finish, knit backing backing.
- ▲ A wide range of colors are available.

Part No.	Color	Width: mm/in	Length: m/yd
F0999A***	Capitano Range	1370 54	33.6 40

### Grand Cayman **PreFixx**

- ▲ Medium emboss, medium shine finish, terry loop - nonwoven backing.
- ▲ A wide range of colors are available.

Part No.	Color	Width: mm/in	Length: m/yd
F0948A***	Grand Cayman Range	1370 54	33.6 40

### Heidi

- ▲ Deep grain emboss, semi-dull finish, terry loop - nonwoven backing.

Part No.	Color	Width: mm/in	Length: m/yd
F0910A008	Brite White	1370 54	27 30
F0910A948	Medium Opal	1370 54	27 30



Prefix by OMNOVA is a unique protective/wipe clean finish that provides immediate cleaning satisfaction without the need for harsh cleaning chemicals.

An original in the industry, OMNOVA's PreFixx protective coating delivers excellent durability and performance by providing a formidable layer of protection against abrasions, grease and grime. Even the toughest stains, like ink, grease and mustard can be wiped away without harming the upholstery when the recommended three-step cleaning process is followed. Please call for more details.



Please refer to the current Nautolex swatch cards for full details of the colors available in each fabric range

### Wallaby **PreFixx**

- ▲ Medium emboss, medium shine finish, terry loop - nonwoven backing.

Part No.	Color	Width: mm/in	Length: m/yd
F0985A998	Black	1370 54	27 30
F0985A008	White	1370 54	27 39

### Monticello

- ▲ Deep grain emboss, medium shine finish, terry loop - nonwoven backing.

Part No.	Color	Width: mm/in	Length: m/yd
F0906A008	Crystal White	1370 54	27 30

### All Star **PreFixx**

- ▲ Smooth emboss, semi-dull finish, knit backing

Part No.	Color	Width: mm/in	Length: m/yd
F0950A***	All Star Range	1370 54	27



## Upholstery Vinyls – Care & Maintenance

Please turn back to page 35 for full details on how to clean and care for upholstery vinyls





### Nautolex Voyager Hidem



▲ Hidem Gimp is made from premium marine grade Nautolex vinyl with PreFixx specially folded onto itself and sewn at both edges to form a 15.9mm / 5/8" binding used to hold/hide staples or tacks and serves to trim/bind fabricated pieces.

▲ Hidem is sold full reels only.



Part No.	Color	Width: mm/in	Av Roll Length: m/yd
LS603WT	Mystic White	15 5/8	22.8 25
LS603OW	Off White	15 5/8	22.8 25
LS603OW	Soft Sand	15 5/8	22.8 25

### Nautolex Voyager Channel Upholstery Quilt, Roll & Pleat



▲ Marine grade Nautolex vinyl with PreFixx and 224gsm/6.6 ounce, 100% polyester batting and liner. The channels in our material are 38mm/1 1/2 inches apart.

▲ Please note channels run perpendicular to the edge of the roll and do not extend the full distance edge to edge. The actual usable material is only 1320mm/52 inches wide.

▲ Weight: 916gsm/37oz per linear yard.



Mystic White

Off-White

Part No.	Color	Width: mm/in	Av Roll Length: m/yd
F0900C008	Mystic White	1370 54	13 14
F0900C058	Off White	1370 54	13 14

### Nautolex Voyager



- ▲ Premium UV protected marine grade expanded vinyl upholstery fabric with knitted fabric backing.
- ▲ 600 hour UV resistance.
- ▲ The unique Nautolex formula with PreFixx ensures an overall protective performance.
- ▲ Expanded vinyl has a fabric mesh backing for reduced stretch.
- ▲ Mildew resistant.
- ▲ Designed to meet California Flammability Regulation 117-75, Sec.E.
- ▲ Outstanding stain resistance and cleanability.
- ▲ Superior abrasion resistance.
- ▲ Eliminates blocking and prevents premature aging.
- ▲ Weight: 678gsm/30oz per linear yard.

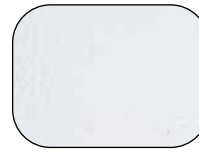

Mystic White

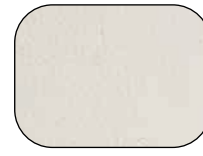

Off-White

Part No.	Color	Width: mm/in	Av Roll Length: m/yd
F0900A008	Mystic White	1370 54	27 30
F0900A058	Off-White	1370 54	27 30

### Nautolex Voyager Welt



- ▲ 5/32" Upholstery Welt.
- ▲ Sold In full 50 yard reels only.
- ▲ Available in Mystic White & Off White.



Part No.	Color	Width: mm/in	Av Roll Length: m/yd
LS605WT	Mystic White	3.968 5/32"	45.9 50
LS605OWT	Off White	3.968 5/32"	45.9 50
LS605SS	Soft Sand	3.968 5/32"	45.9 50

Page Navigation

Please see page 39 for information on our range of upholstery hardware products.



Note: Color representation from 4-color process is for reference purposes only. Please inquire for color sample of actual fabric.

## Shelter-Rite® 18oz

The most popular weight vinyl coated polyester product in the trucking industry. It features excellent tear, good abrasion and overall durability.

- ▲ Coated for excellent abrasion, puncture & tear resistance.
- ▲ Water resistant. Non-wicking.
- ▲ Cold crack -60°F. Not affected by extreme temperature changes.
- ▲ Resistant to fungicidal growth.
- ▲ Will not become stiff due to volatility loss.
- ▲ Uses: Truck covers, tailgate curtains, marine covers, gym.
- ▲ Weight: 610gsm/18oz sq yd.



Part No.	Color	Width: mm/in	Av Roll Length: m/yd
FH418WT	White	1550 61	101 110
FH418RD	Red	1550 61	101 110
FH418BU	Royal Blue	1550 61	101 110
FH418YE	Yellow	1550 61	101 110
FH418GY	Gray	1550 61	101 110
FH418BK	Black	1550 61	101 110
FH418BI	Beige	1550 61	101 110

## Shelter-Rite® 22oz

Extra heavy duty vinyl coated polyester product. It features excellent tear, good abrasion and overall durability.

Part No.	Color	Width: mm/in	Av Roll Length: m/yd
FH422WT	White	1550 61	101 110
FH422BU	Blue	1550 61	101 110



## Bainflate 210 - 7.5 oz Vinyl

210d plain nylon with a balanced, pigmented PVC coating.

- ▲ UV resistant, waterproof, good tear tensile strength.
- ▲ Uses: Inflatable advertising structures, canopies, banners.
- ▲ \* Color to be phased out.
- ▲ Weight: 255gsm/7.5oz/sq yd.

Part No.	Color	Width: mm/in	PMS
FH210WT	White	1530 60	
FH210RB	Royal Blue	1530 60	293
FH210NV	Navy Blue	1530 60	228
FH210YE	Yellow	1530 60	116
FH210GR	Green	1530 60	336
FH210RD	Red	1530 60	187
FH210OR	Orange	1530 60	172
FH210GY	Gray	1530 60	007
FH210BK	Black	1530 60	
FH210BGR	Bright Green	1530 60	355

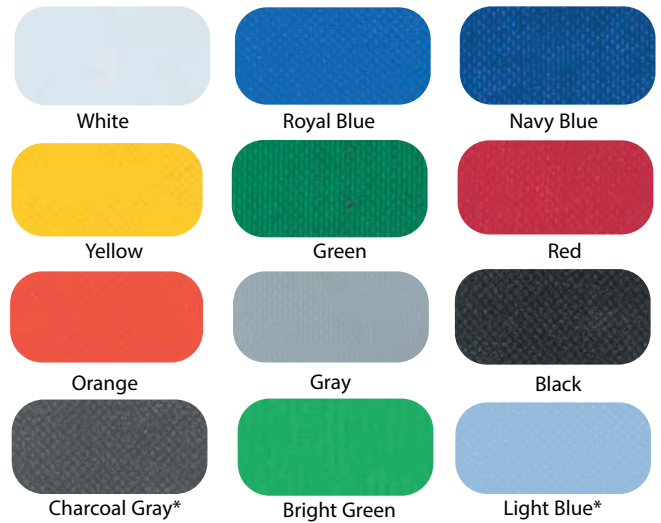

## Baintex 600

600 Denier woven nylon with embossed pigmented PVC coating one-sided. Other colors are now available to special order. Full rolls only.

- ▲ Accepts pressure sensitive graphics or screen printing.
- ▲ Fire retardant, meets California fire code 117, section E.
- ▲ Uses: Golf bags, banners/signs, indoor awnings & covers.
- ▲ Weight: 373gsm/11oz/sq yd.



Part No.	Color	Width: mm/in	Av Roll Length: m/yd
FH600BK	Black	1530 60	45.7 50
FH600NV	Navy Blue	1530 60	45.7 50
FH600RB	Royal Blue	1530 60	45.7 50
FH600RD	Red	1530 60	45.7 50
FH600SR	Silver	1530 60	45.7 50

Note: Color representation from 4-color process is for reference purposes only. Please inquire for color sample of actual fabric.

## “1.9 Ounce” 70 Denier Ripstop Nylon

- ▲ 70d ripstop nylon with a ¾ ounce urethane coating.
- ▲ Light weight and strong. with very good tear strength.
- ▲ Uses: Windssocks, flags and banners, cold air inflatable advertising structures, dancing tubes.
- ▲ Other colors are available to special order.
- ▲ \*FR Version is also available in several colors to meet CPAI 84 and ISO 6940.
- ▲ Weight: 88gsm/2.6oz/sq yd. and ISO 6940.

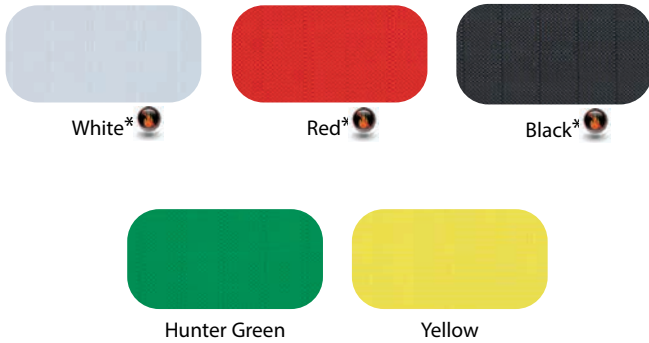

Part No.	Color/PMS	Width: mm/in	Av Roll Length: m/yd
FH019WT*	White	1520 60	92 100
FH019GR	Hunter Green	1520 60	92 100
FH019RD*	Red/187	1520 60	92 100
FH019YE	Yellow/101	1520 60	92 100
FH019BK*	Black	1520 60	92 100

## 210 Denier Oxford Nylon

- ▲ Durable, water repellent urethane coated, UV inhibited 210 denier nylon.
- ▲ Uses: Sail bags, soft-sided luggage, backpacks, garment bags, stuff bags, flags, banners, apparel.
- ▲ Other colors are available to special order - full rolls only.
- ▲ Weight: 105gsm/3.1oz/sq yd.



Part No.	Color	Width: mm/in	Av Roll Length: m/yd
F5600D00W	White	1520 60	101 110
F5600D10W	Red	1520 60	101 110
F5600D79W	Royal Blue	1520 60	101 110



### Caution!

Nylon High Intensity colors are likely to fade quickly. Nylon may bleed when wet!

## 420 Denier Nylon Pack Cloth

- ▲ 420 denier x 420 denier nylon with urethane coating.
- ▲ Uses: Sail bags, soft-sided luggage, backpacks, garment bags, stuff bags.
- ▲ Other colors are available to special order - full rolls only.
- ▲ Weight: 193gsm/5.7oz/sq yd.
- ▲ Note: Yellow is now available only to special order.

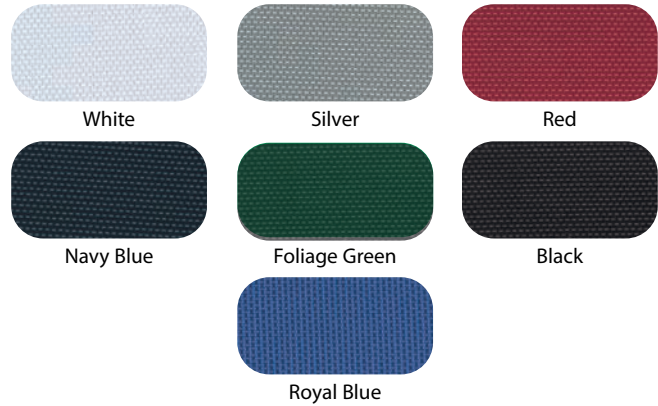

Part No.	Color	Width: mm/in	Av Roll Length: m/yd
F5240D00W	White	1520 60	64 70
F5240D08W	Silver	1520 60	64 70
F5240D10W	Red	1520 60	64 70
F5240D22W	Navy Blue	1520 60	64 70
F5240D47W	Foliage Green	1520 60	64 70
F5240D60W	Black	1520 60	64 70
F5240D79W	Royal Blue	1520 60	64 70

## 1000 Denier Texturized Nylon

- ▲ 1000 denier super tough woven, high tenacity nylon with a 33gsm/1 ounce urethane coating for durability and water repellency.
- ▲ Excellent resistance to abrasion, tear. High tensile strength
- ▲ Uses: Heavy duty bags, soft-sided luggage, apparel, horse blankets, backpacks, recreational equipment.
- ▲ Weight: 458gsm/13.5oz/sq yd.

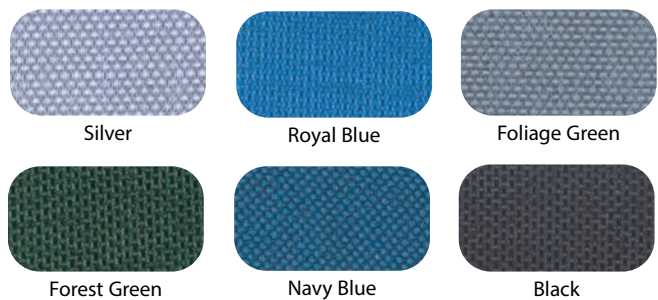

Part No.	Color	Width: mm/in	Av Roll Length: m/yd
F5300D08W	Silver	1520 60	46 50
F5300D47W	Foliage Green	1520 60	46 50
F5300D79W	Royal Blue	1520 60	46 50
F5300D22W	Navy Blue	1520 60	46 50
F5300D46W	Forest Green	1520 60	46 50
F5300D60W	Black	1520 60	46 50

Note: Color representation from 4-color process is for reference purposes only. Please inquire for color sample of actual fabric.

## Polyester Three Bar Knit Mesh

- ▲ Uses: Flags, windsocks, sublimated graphic etc.
- ▲ Weight: 130gsm/3.8oz/Sq yd.

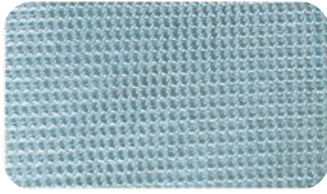

Part No.	Color	Width: mm/in		Roll Length: m/yd	
FHKP60WT	White	1530	63	91	100

## Light Weight Polyester Knit Mesh

- ▲ Uses: Breathable panels for bags/safety nets.
- ▲ Weight: 109gsm/3.2oz/Sq yd.

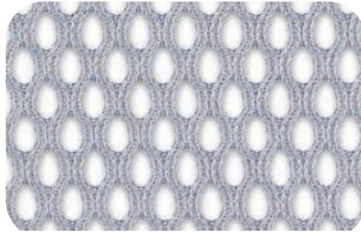

Part No.	Color	Weight: gsm/oz/sq yd		Width: mm/in		Roll Length: m/yd
FH062WT	White	109	3.2	1575	62	160 175
FH062BK	Black	109	3.2	1575	62	160 175

## Heavy Weight Polyester Knit Mesh

- ▲ Uses: Breathable panels for bags/safety nets.
- ▲ Weight: 339gsm/10oz/Sq yd.

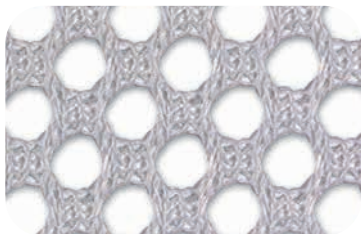

Part No.	Color	Weight: gsm/oz/sq yd		Width: mm/in		Roll Length: m/yd
FH063WT	White	339	10	1600	63	46 50

Page Navigation

**Webbing**  
Please turn to pages 106-109 for our full range of nylon, polyester and polypropylene webbing products.



## "No See-Um" Polyester Netting

- ▲ Flame retardant: CPAI84.
- ▲ Uses: For insect screens.
- ▲ Weight: 31gsm/0.9oz/sq yd.



Part No.	Color	Width: mm/in		Roll Length: m/yd	
FH172GY	Slate Gray	1830	72	183	200

## Fiberglass Screen

- ▲ Long wear fiberglass screen with excellent flexing and superior ultraviolet resistance.
- ▲ Fire retardant (CPAI-84).
- ▲ 18 x 14 construction.
- ▲ Uses: Insect and bug screens. Boat cover vents.
- ▲ Weight: 85gsm/2.5oz/Sq yd.

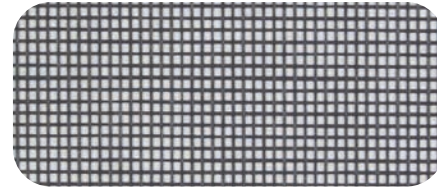

Part No.	Color	Width: mm/in		Roll Length: m/yd	
FH372CG	Charcoal	1830	72	30	33

## Guard Rail Safety Netting

- ▲ 100% Nylon Diamond Mesh - reinforced top & bottom edge.
- ▲ Height: 15 3/4" - 24" / 40 - 60cm.
- ▲ Length\* depends on height of lifeline.
- ▲ Diamond Mesh Aperture: 55mm / 2 3/16"
- ▲ Cord Clanch: 2mm / 5/64".



Part No.	Color	Width: cm/in		Roll Length: m/yd*	
P14938	White	40-60	15 3/4" - 24"	10m	32.8ft

## Heavy Duty Tramp

- ▲ Heavy duty trampoline is a very strong woven polyester mesh with a thick vinyl coating & UV/mildew inhibitors.
- ▲ Designed for industrial applications as well as trampolines on large catamarans.
- ▲ Weight: 848gsm/25oz/sq yd.

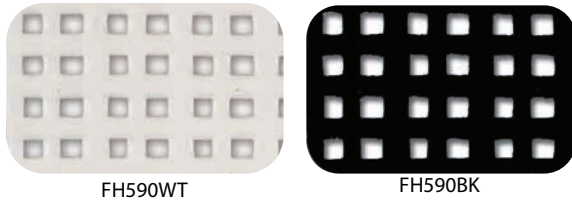

Part No.	Color	Roll Width: mm/in	Roll Length: m/yd
FH590WT	White	1800 71	50 54
FH590BK	Black	1800 71	50 54

## Extra Heavy Duty SuperTramp

- ▲ SuperTramp, with mildew inhibitors, designed for tensile structures. High strength, durability and resistance to the elements.
- ▲ Can be used for large catamaran applications, - greater strength and durability than standard trampoline products. It has also been used for large fixed outdoor shades, with FR standard M2 rating (equals NFPA 701).
- ▲ Weight: 1017gsm/30oz/sq yd.



Part No.	Color	Roll Width: mm/in	Roll Length: m/yd
FH592WT	White	1800 71	50 54

## Multi-Purpose Vinyl Tight Mesh

- ▲ 9 x 12 knitted polyester mesh with vinyl coating.
- ▲ White mesh is fire retardant and meets California Fire Marshall 117, section E specifications.
- ▲ Uses: Wind and sun screens, banners, breathable cushion bottoms.
- ▲ Weight: 271gsm/8oz/sq yd.



Part No.	Color	Roll Width: mm/in	Roll Length: m/yd
FH162WTFR	White	1520 62	91 100

## Sleeveknit Vinyl Mesh

- ▲ 9 x 9 knitted polyester mesh with vinyl coating.
- ▲ Uses: Windscreens, banners, outdoor furniture, shades.
- ▲ Weight: 220gsm/6.5oz/sq yd.



Part No.	Color	Roll Width: mm/in	Roll Length: m/yd
FH160RD	Red	1524 60	91.4 100
FH160GR	Green	1524 60	91.4 100
FH160BK	Black	1524 60	91.4 100
FH160BK	Blue	1524 60	91.4 100
FH160WT	White	1524 60	91.4 100

## Trampoline Cloth

- ▲ UV inhibited monofilament polypropylene basketweave.
- ▲ Weight: 270gsm/8oz/sq ft.



Part No.	Color	Width: mm/in	Roll Length: m/yd
FH374BK	Black	1880 74	45.7 50



Note: Color representation from 4-color process is for reference purposes only. Please inquire for color sample of actual fabric.

## TEXTILENE® - Mesh

- ▲ PVC vinyl encapsulated polyester mesh.
- ▲ 45%-65% shade factor depending on color.
- ▲ Very strong, good tear & abrasion resistance.
- ▲ Fire retardant, meets California Fire Marshall 117, sec E.
- ▲ Uses: Wind and sun screens, breathable cushion bottoms, signs and banners.
- ▲ Weight: 350gsm/10.3oz/sq yd.



Part No.	Color	Roll Width: mm/in	Roll Length: m/yd
FH354WT	White	1370 54	59 65
FH354GY	Dove Gray	1370 54	59 65
FH354NV	Navy Blue	1370 54	59 65
FH354RB	Royal Blue	1370 54	59 65
FH354BK	Black	1370 54	59 65
FH354AL	Driftwood	1370 54	59 65
FH354GR	Forest Green	1370 54	59 65
FH354YE	Yellow	1370 54	59 65

## TEXTILENE PLUS® - Mesh

- ▲ PVC vinyl encapsulated polyester mesh.
- ▲ 88% to 92% shade factor depending on color & profile angle.
- ▲ Fire retardant: CA Title 19, NFPA 701-2004.
- ▲ Weight: 414gsm 12.2oz/sq yd.
- ▲ Note: \*This range is to be phased out by the mill in 2015.



Part No.	Color	Roll Width: mm/in	Roll Length: m/yd
FH352BI*	Beige	1525 61	54 60
FH352DSD*	Desert Tan	1525 61	54 60
FH352DGR*	Dark Green	1525 61	54 60

## SUNSURE® - Mesh

- ▲ 42 x 12 woven PVC vinyl encapsulated polyester mesh material.
- ▲ 95% shade factor.
- ▲ Fire retardant to California Fire Marshall 117, Sec E.
- ▲ Uses: Wind and sun screens, banners.
- ▲ Weight: 550gsm/16.3oz/sq yd.

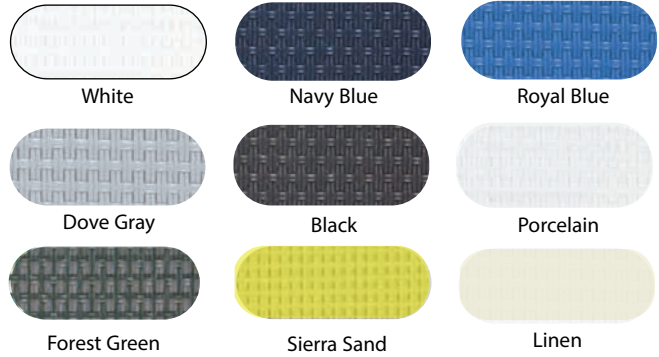

Part No.	Color	Roll Width: mm/in	Roll Length: m/yd
FH359WT	White	1370 54	59 65
FH359NV	Navy Blue	1370 54	59 65
FH359RB	Royal Blue	1370 54	59 65
FH359SD	Sierra Sand	1370 54	59 65
FH359PN	Porcelain	1370 54	59 65
FH359GY	Dove Gray	1370 54	59 65
FH359GR	Forest Green	1370 54	59 65
FH359BK	Black	1370 54	59 65
FH359LN	Linen	1370 54	59 65

## SUNSURE PLUS® - Mesh

- ▲ PVC vinyl encapsulated 500d polyester.
- ▲ 95% shade factor.
- ▲ Fire retardant: CA Title 19 & NFPA 701-2004.
- ▲ Uses: Screens, banners, outdoor furniture.
- ▲ Weight: 485gsm/14.3oz/sq yd.
- ▲ Note: \* to be phased out by the mill

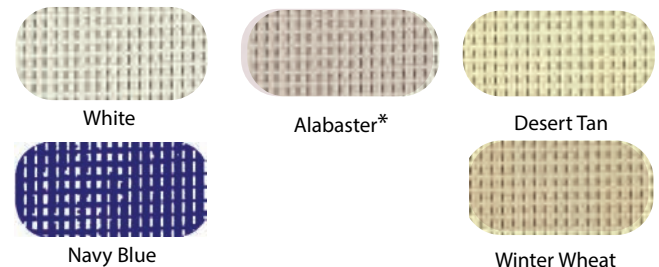

Part No.	Color	Roll Width: mm/in	Roll Length: m/yd
FH357ALB*	Alabaster	1525 61	54 60
FH357WT	White	1525 61	54 60
FH357DSD	Desert Tan	1525 61	54 60
FH357WWH	Winter Wheat	1525 61	54 60
FH357NV	Navy Blue	1525 61	54 60

Note: Color representation from 4-color process is for reference purposes only. Please inquire for color sample of actual fabric.



## TEXTILENE 80® - Mesh



- ▲ PVC vinyl coated 1000d polyester mesh.
- ▲ Up to 80% shade factor depending on color.
- ▲ Very strong, excellent tear & abrasion resistance.
- ▲ Fire retardant, meets CS191-53 & CA 117 sec E.
- ▲ Uses: Wind and sun screens, breathable cushion bottoms, signs and banners.
- ▲ Width: 72"/183cm
- ▲ Weight: 441gsm/13oz/sq yd.

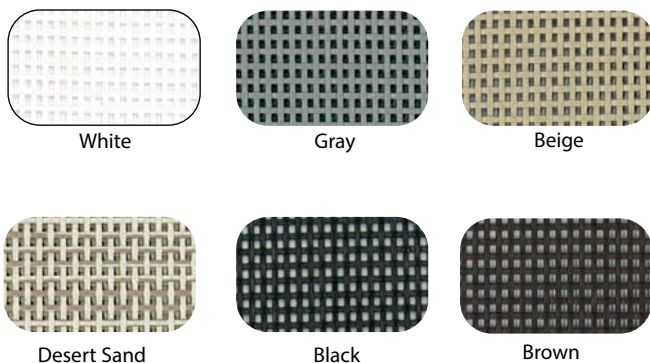

▲ Other widths available by special order.

Part No.	Color	Roll Width: mm/in		Roll Length: m/yd	
FH358BEG72	Beige	1830	72	59	65
FH358BK72	Black	1830	72	59	65
FH358BRN72	Brown	1830	72	59	65
FH358DSD72	Desert Sand	1830	72	59	65
FH358GY72	Gray	1830	72	59	65
FH358WT72	White	1830	72	59	65



## TEXTILENE 90® - Mesh



- ▲ PVC vinyl coated 1000d polyester mesh.
- ▲ Up to 90% shade factor depending on color.
- ▲ Very strong, excellent tear & abrasion resistance.
- ▲ Fire retardant, meets California Fire Marshall 117, sec E, CA Title 19, NFPA 701.
- ▲ Uses: Wind and sun screens, breathable cushion bottoms, signs and banners, Privacy Screens.
- ▲ Weight: 536gsm/16oz/sq yd.
- ▲ Width: 72"/183cm.

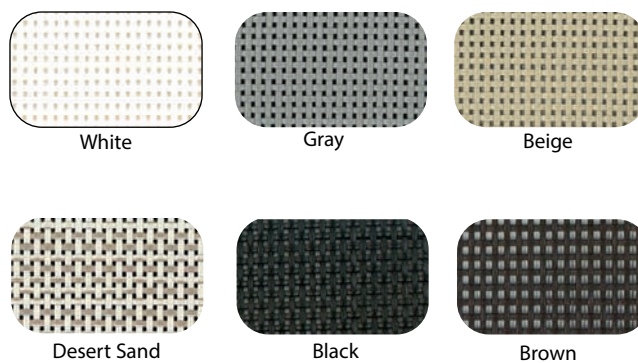

▲ Other widths available by special order.

Part No.	Color	Roll Width: mm/in		Roll Length: m/yd	
FH355BEG72	Beige	1830	72	59	65
FH355BK72	Black	1830	72	59	65
FH355BRN	Brown	1830	72	59	65
FH355DSD72	Desert Sand	1830	72	59	65
FH355GY72	Gray	11830	72	59	65
FH355WT72	White	1830	72	59	65

Part No.	Color	Roll Width: mm/in		Roll Length: m/yd	
FH355BEG12	Beige	1830	120	59	65
FH355BK12	Black	1830	120	59	65

Page Navigation

Awning Track & Keder  
Please turn to pages 64 & 65  
for our full range of Keder Tape  
and Awning Track products.



Note: Color representation from 4-color process is for reference purposes only. Please inquire for color sample of actual fabric.



**CLEARLY SUPERIOR**  
PRESS POLISHED VINYL WINDOWS

**Continental** delivers outstanding optical clarity, durability and versatility for boats and vehicles.

Easy to Clean | Scratch Resistant Special Coating |  
UV Resistant | Sunscreen, Bug Spray & Jet Fuel Resistant |  
Preferred OEM Supplier



Made in the USA



Don't forget to  
**CLEAN, PROTECT, PRESERVE**

## O'Sea® Scratch Resistant Window Glass

- ▲ Best quality scratch resistant clear PVC material.
- ▲ Excellent UV durability.
- ▲ Available only in full drums.
- ▲ Note: Item K228/3SM\* is Light Gray Smoke tint.
- ▲ Made In the USA.

Part No.	Gauge Thickness: mm/in	Width: mm/in	Sheet Length: mm/in	Sheets Per Drum
K227-3	0.75 0.030	1370 54	2820 110	3
K227-5	0.75 0.030	1370 54	2820 110	5
K228-3	1.02 0.040	1370 54	2820 110	3
K228-3SM*	1.02 0.040	1370 54	2820 110	3
K228-5	1.02 0.040	1370 54	2820 110	5
K229-3	1.53 0.060	1370 54	2820 110	3



## Aquatech - Cleaner & Protectant

- ▲ Protects and cleans clear vinyl and polycarbonate.
- ▲ Does not contain ammonia or alcohol.
- ▲ Cleans, shines and protects clear vinyl while leaving a water repellent finish.



Part No.	Description	Liquid Measure: ml/floz	Case Qty
M185	Aquatech Cleaner & Protectant	473 16	12

## Regalite® Pressed Polished Window Materials

- ▲ Best quality glass-clear PVC material.
- ▲ Regalite is a registered trademark of O'Sullivan Films, Inc.



Part No.	Gauge Thickness: mm/in	Sheet Width: mm/in	Sheet Length: mm/in	Qty per Drum
K221	0.50 0.020	740 29	1730 68	45
K222-5	0.76 0.030	1370 54	2794 110	5
K223	1.02 0.040	610 24	1370 54	35
K225-3	1.02 0.040	1370 54	2794 110	3
K225-5	1.02 0.040	1370 54	2794 110	5

## Novus Plastic Polish

- ▲ Novus 1 gently cleans plastic without scratching. Leaves shines that resists fogging, repels dust and eliminates static. Contains no abrasives.
- ▲ Novus 2 removes fine scratches and haziness, helps restore faded and discolored plastics.
- ▲ Novus 3 Removes heavy scratches and abrasion from most acrylic surfaces. Use when damage is too severe for No. 2 polish.
- ▲ Use on Lexan, Plexiglass, clear vinyl, monofilm, polycarbonate, etc.



M171



M172



M173

Part No.	Description	Liquid Measure: ml/floz	Case Qty
M174KIT	Novus#1 & #2 & Polish Mates	59 2	12
M171	Novus#1	59 2	12
M181	Novus#1	236 8	12
M172	Novus#2	59 2	12
M182	Novus#2	236 8	12
M173	Novus#3	59 2	12
M183	Novus#3	236 8	12
M180	Polish Mates Cloth (10/pack)	- -	48

# Marine Fabric for All Types of Weather



Webton®  
**regatta**®



Proud Member  
of IFAI and MFA



# HERCULITE®

Powered by Innovation ♦ Proven by Performance

## Crystal Clear "20/20"

- ▲ Clear press-polished vinyl sheet produced by Strataglass.
- ▲ Same quality clarity, and perfection as Strataglass.
- ▲ Available only in full drums.



Canvas Designers Inc, FL.

## Crystal Clear - Clear & Smoke Tint

Part No.	Gauge Thickness: mm/in		Width: mm/in		Sheet Length: mm/in		Sheets Per Drum
K130-3	0.76	0.030	1370	54	2820	111	3
K130-5	0.76	0.030	1370	54	2820	111	5
K140-3	1.02	0.040	1370	54	2820	111	3
K140-5	1.02	0.040	1370	54	2820	111	5
K140-5LSM	1.02	0.040	1370	54	2820	111	5

### General Maintenance

When New: 3M Adhesive Remover may be used to remove glue left from fabrication. Final clean with IMAR Strataglass Protective Cleaner. We recommend using IMAR Strataglass Protective Polish as the final step in installation to provide a base of protection and a good watershed.

For the Customer: We recommend using IMAR Strataglass Protective Polish every 2 – 3 months (every 4 – 6 weeks in areas of high fallout). In the interim, use IMAR Strataglass Protective Cleaner frequently.

Note: All new vinyl can easily get impressions on itself. We recommend new enclosures to be left in place to the extent possible. If completely removed must be interleaved with either acid-free paper (available from framing shops) or old sheets (the best choice) to prevent 'pooling' in the glass. Vinyl 'seasons' over time and becomes less impressionable. Roll all curtains down and fasten in place nightly to keep perfect appearance. (Review this information at: [www.strataglass.com](http://www.strataglass.com))



Page Navigation

**Awning Track & Keder**  
Please turn to page 53 for the full range of IMAR cleaners, polish and protectant products.



## Strataglass - Scratch Resistant Glass

- ▲ Leading scratch resistant clear vinyl.
- ▲ Tested to 12 years accelerated UV.
- ▲ Easy roll-up, the same as regular vinyl.
- ▲ Available only in full drums.
- ▲ UV Blocking.
- ▲ Use: boat curtains, automotive windows, tents & awnings.



Canvas Designers Inc, FL.

# STRATAGLASS™

## Strataglass - Clear

Part No.	Gauge Thickness: mm/in		Width: mm/in		Sheet Length: mm/in		Sheets Per Drum
K305-2	0.76	0.030	1370	54	2820	111	2
K305-5	0.76	0.030	1370	54	2820	111	5
K310-2	1.02	0.040	1370	54	2820	111	2
K310-3	1.02	0.040	1370	54	2820	111	3
K310-5	1.02	0.040	1370	54	2820	111	5
K315-2	1.50	0.060	1370	54	2820	111	2

## Strataglass - Smoke Tint

Part No.	Gauge Thickness: mm/in		Width: mm/in		Sheet Length: mm/in		Sheets Per Drum
K310-2SM	1.02	0.040	1370	54	2820	111	2
K310-5SM	1.02	0.040	1370	54	2820	111	5
K315-2LSM	1.02	0.060	1370	54	2820	111	2

### Strataglass – Care & Maintenance

We recommend using only IMAR Strataglass Protective Polish, IMAR Strataglass Protective Cleaner and mild soap (preferably IMAR Yacht Soap Concentrate) on Strataglass. (We no longer recommend the use of any other products regardless of the manufacturer's claims.)



### Caution!

- ▲ Use of RAINEX on Strataglass appears to work for a short time but then dulls the surface and presents an 'Orange Peel' effect. Do not use RAINEX.
- ▲ Use of cleaners, polishes, scratch removers, or any other product made from regular, uncoated vinyl will damage Strataglass. Do not use these products.
- ▲ DO NOT HANDLE STRATAGLASS (OR ANY VINYL) WITH SUNSCREEN ON YOU HANDS! This will permanently cloud the vinyl where handled.

## Roll-A-Glass Window Material

- ▲ Clear vinyl.
- ▲ Best quality roll goods available. Can use RF to heat seal seams against water penetration.
- ▲ K230/232 Glass - clear with paper interleaving for protection.



Part No.	Gauge Thickness: mm/in		Roll Width: mm/in		Roll Length: m/yd	
K230	0.40	0.016	1370	54	23	25
K232	0.50	0.020	1370	54	18.2	20
K333	0.76	0.030	1370	54	18.2	20
K334	1.02	0.040	1370	54	13.7	15

## Roll-A-Glass Scratch Resistant Material

K442SR	0.76	0.030	1194	47	21	23
--------	------	-------	------	----	----	----

## Super Clear FR Roll Glass

- ▲ Sparkling clarity, better quality UV window material.
- ▲ Rated at -20°F cold crack.
- ▲ Fire resistant: Meets CAPI-84 CSFM, NFPA-701.



Part No.	Gauge Thickness: mm/in		Roll Width: mm/in		Roll Length: m/yd	
K231FR	0.48	0.018	1370	54	27.4	30
K333FR	0.76	0.030	1370	54	18.2	20

## 1000 hour UV Roll-A-Glass

- ▲ Clear vinyl.
- ▲ Sparkling clarity.
- ▲ Extended UV life window material.
- ▲ 0°F cold crack.
- ▲ FMV 302 Fire resistant.



Passes 1000 hour UV weatherometer

Part No.	Gauge Thickness: mm/in		Roll Width: mm/in		Roll Length: m/yd	
K631	0.50	0.020	1370	54	27.4	30

## CLEAR-VU High Optical Clarity Roll Glass

Clear-VU is a top quality extruded vinyl product that offers optical clarity approaching the best press polished sheet vinyl, while still retaining the benefits of roll glass convenience.

- ▲ K432 is a soft hand similar to roll-a-glass in stiffness.
- ▲ K434 has a firm hand as pressed polished sheets.



Part No.	Gauge Thickness: mm/in		Roll Width: mm/in		Roll Length: m/yd	
K432	0.76	0.030	1370	54	18.2	20
K434	1.02	0.040	1370	54	14.0	15.3
K434SO	1.02	0.040 soft	1370	54	14.0	15.3



Caution!

### Do Not:

- ▲ Use harsh detergents.
- ▲ Use Products containing silicones or alcohol. This will age vinyls.
- ▲ Rub the plastic window when dry. This will scratch the window. Always flood the window with water before gently wiping it with a damp, soft cotton cloth.
- ▲ Stow the convertible top when it is dirty because it will scratch or mildew.

## Clear Vinyl Care & Cleaning

The smooth, highly polished surfaces of flexible plastic windows & clear vinyl are sensitive and can be easily scratched and marred if mishandled during unpacking, handling and cleaning.

- ▲ Never pull individual sheets from a drum as this will cause scratches across the narrow width of the sheet.
- ▲ DO NOT put any weight onto "Roll A Glass". It is better to store rolls standing up.
- ▲ Never use harsh brushes or abrasives when cleaning plastic windows.
- ▲ The effect of sunlight combined with environmental pollution will actually alter the chemical structure of your plastic window, resulting in permanent discoloration and brittleness.
- ▲ To maintain the clarity and extend the life of your plastic window, it is essential that you wash dirt and salt water off the surfaces and treat the window on a regular basis with 303 UV Protection or 210 products.



## X-Clear Polyester Film

- ▲ Black polyester DIAX laminated with 4 mil optically clear film.
- ▲ Low stretch, high tear strength.
- ▲ Ideal for laminate and woven race sail windows.



Part No.	Thickness: mm/in		Roll Width: mm/in	
F6002X00M	0.15	0.006	1370	54

## Monofilm

- ▲ See-through polyester film for a light weight performance material for boardsails and telltale windows.
- ▲ Use J090 series seaming tapes (see page 114) for sewing panels together.

Part No.	Gauge Thickness: mm/in/microns			Roll W/dth: mm/in	Roll Length: m/yd		Weight: gm/oz
E078	0.12	0.005	120	1370 54	46	50	111 3.9
E088	0.18	0.007	180	1370 54	46	50	156 5.5
E080	0.25	0.010	250	1370 54	46	50	224 7.9

## 210 Cleaner & Polish

- ▲ Easy removal of all kinds of marks.
- ▲ Provides anti-static/anti-fog coating.
- ▲ Can be used on polycarbonate, acrylic, fiberglass, formica, PVC and others.



Part No.	Description	Liquid Measure: ml/floz		Case Qty
M210/7	210 Cleaner	207	7	12
M210/14	210 Cleaner	414	14	12
M211/15	210 Scratch Remover/Polish	443	15	12

## IMAR Yacht Soap

- ▲ Formulated to create highly polished appearance, non-streaking, non-spotting.
- ▲ Rinses clear and decreases drying time.
- ▲ No harsh alkalis, acids or abrasives.



M224/16

M224/128

Part No.	Description	Liquid Measure: ml/floz		Case Qty
M224/16	Bottle	473	16	12
M224/128	Gallon Refill	3785	128	4

## IMAR Strataglass Protective Cleaner

- ▲ Uniquely formulated to clean and shine and protect Strataglass & Crystal Clear 20/20.
- ▲ Special UV inhibitors extend the useful life of Strataglass by minimizing the deteriorating effects of sunlight.
- ▲ Safe for use daily and recommended to use often.



Part No.	Description	Liquid Measure: ml/floz		Case Qty
M221/4	Pump Spray	118	4	24
M221/16	Pump Spray	473	16	12
M221/128	Gallon Refill	3785	128	4

## IMAR Strataglass Protective Polish

- ▲ Formulated to safely clean, polish and protect Strataglass and Crystal Clear 20/20.
- ▲ Creates a nearly invincible protective barrier against the damaging effects of marine pollutants.
- ▲ Recommended for use every 2 – 3 months.
- ▲ Frequent use of Imar Strataglass Protective Cleaner between polishing will increase protection.



Part No.	Description	Liquid Measure: ml/floz		Case Qty
M222/4	Bottle	118	4	24
M222/16	Bottle	473	16	12

## Color Availability

Part No.	Description
FS4751	Hemlock Tweed Fancy
FS4755	Pacific Blue Fancy
FS4762	Era Silk Stripe
FS4763	Era Indigo
FS4766	Era Ash
FS4767	Preston Radiance
FS4768	Preston Stone
FS4770	Providence Americana
FS4776	Chocolate Chip Fancy
FS4777	Gray/Beige Chip Fancy
FS4778	Essex Curry
FS4789	Manhattan Classic
FS4790	Forest Green Fancy
FS4796	Beige/White Fancy
FS4798	Burgundy/Black/White
FS4799	Gray/Black/White
FS4806	Forest Green/Natural 6 Bar
FS4813	Eastland Redwood
FS4817	Westfield Mushroom
FS4856	Colonnade Juniper
FS4857	Colonnade Redwood
FS4859	Silica Dune
FS4860	Silica Sesame
FS4861	Silica Stone
FS4862	Silica Silver
FS4868	Kiawah Spa
FS4876	Manhattan Fog
FS4878	Rodanthe Sunrise
FS4884	Saxon Cascade
FS4885	Saxon Chili
FS4887	Westport
FS4888	Clinton Granite
FS4889	Courtland Pebble
FS4891	Manhattan Dune
FS4894	Motive Dusk
FS4895	Motive Denim
FS4896	Silica Sage
FS4897	Silica Charcoal
FS4901	Captain Navy/Forest Green/Yellow/Red
FS4902	Captain Navy/Natural Classic
FS4907	Taupe Five Bar
FS4909	Plum Fancy
FS4916	Navy/Taupe Fancy
FS4921	Mediterranean/Canvas Block Stripe
FS4923	Black Forest Fancy
FS4932	Forest Green/Beige/Natural
FS4939	Brass/Black Cherry Classic
FS4945	Taupe Tailored Bar Stripe
FS4946	Black/Taupe Fancy
FS4948	Sapphire Vintage Bar Stripe
FS4949	Forest Vintage Bar Stripe
FS4954	Heather Beige Classic
FS4955	Fern Classic
FS4959	Fern/Heather Beige Block Stripe
FS4961	Putty Regimental
FS4969	Henna/Fern

## Sunbrella® Stripe

- ▲ 100% solution dyed woven acrylic fabric in 1170mm/46 inch widths.
- ▲ Excellent fade and weather resistance.
- ▲ Durable, UV resistant.
- ▲ Colorfast, water repellent, mildew and stain resistant.
- ▲ Breathable for moisture evaporation/cooler covered area.
- ▲ Fabric covered by 10 year limited warranty.
- ▲ Average roll length: 59m/65 yards.
- ▲ Weight: 305gsm/9oz sq yd.

Part No.	Description
FS4985	Havelock Brick
FS4987	Cooper Navy
FS4988	Cooper Black
FS4989	Hatteras Raven
FS4992	Baycrest Sky
FS4993	Baycrest Pacific
FS4994	Eastridge Cocoa
FS4995	Ashford Forest
FS5702	Yellow/White 6 Bar Stripe
FS5704	Black/White 6 Bar Stripe



Page Navigation

Sunbrella® Solid Colors  
Please turn to pages 8 & 9 for  
more details on the full range.







Note: Color representation from 4-color process is for reference purposes only. Please inquire for color sample of actual fabric.

## Firesist

- ▲ Fire-retardant product woven from high UV and fade resistant, solution dyed fiber & backed with a durable urethane/acrylic coating.
- ▲ Meets NFPA701-99, test method II fire retardant specifications.
- ▲ Meets many other fire codes for exterior & interior use.
- ▲ Weight: Approx. 297 gsm/8.75oz sq yd.
- ▲ Width: 1520mm / 60".

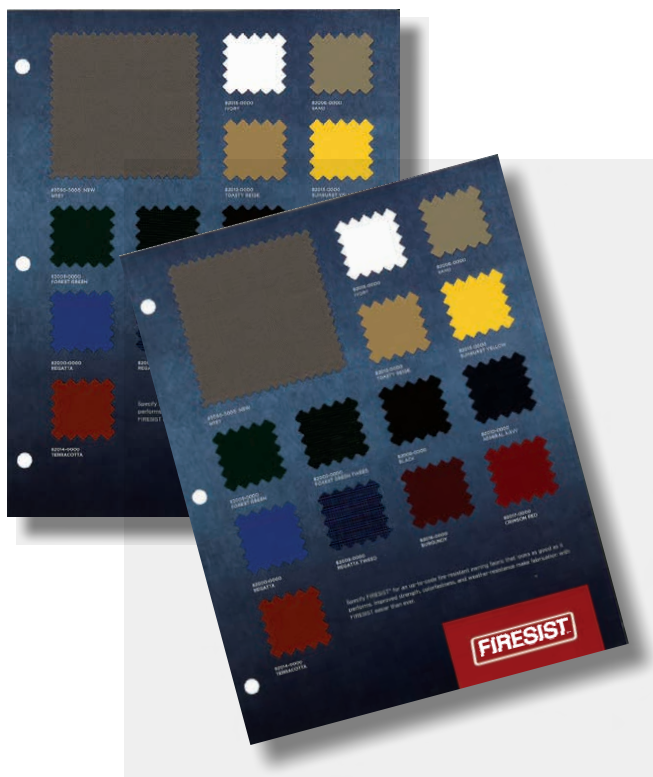

Part No.	Color	Finished Width: mm/in	
FS82200	Regatta	1520	60
FS82002	Forest Green Tweed	1520	60
FS82003	Forest Green	1520	60
FS82005	Regatta Tweed	1520	60
FS82006	Sand	1520	60
FS82008	Black	1520	60
FS82010	Admiral Navy	1520	60
FS82012	Toasty Beige	1520	60
FS82013	Sunburst Yellow	1520	60
FS82014	Terracotta	1520	60
FS82015	Ivory	1520	60
FS82016	Burgundy	1520	60
FS82017	Crimson Red	1520	60
FS82030	Gray	1520	60

## Sunbrella® Plus

- ▲ 100% solution dyed Acrylic fabric with a water resistant urethane coating.
- ▲ Resists sunlight, mildew, rot and atmospheric chemicals.
- ▲ Excellent abrasion resistance.
- ▲ Dimensionally stable.
- ▲ Bright and colorfast - regular Sunbrella compatible.
- ▲ Use Sunbrella Plus for: canopies, biminis, dodgers, awnings, travel covers & camper tops.
- ▲ Average roll length: 59m/65 yards.
- ▲ Other colors available against special order.
- ▲ Weight: Approx. 348gsm/10.25 oz sq yd.



Part No.	Color	Finished Width: mm/in	
FS8430	Cadet Gray	1520	60
FS8401	Pacific Blue	1520	60
FS8417	Royal Blue	1520	60
FS8428	Toast	1520	60
FS8437	Forest Green	1520	60
FS8404	Natural	1520	60
FS8408	Black	1520	60
FS8442	Oyster	1520	60
FS8446	Captain Navy	1520	60
FS8479	Ocean Blue	1520	60



## Sunbrella Products Care & Cleaning

Sunbrella® fabric should be cleaned regularly before substances such as dirt, roof particles, etc. are allowed to accumulate on and then become embedded in the fabric.

Clean the fabric only with mild detergent solution and rinse well. Do not allow the fabric to be folded up for long periods of time when wet.

Please refer to the full cleaning instructions on the manufacturers color swatch card.

Note: Color representation from 4-color process is for reference purposes only. Please inquire for color sample of actual fabric.

## Weathermax 80



A patented outdoor performance fabric developed for demanding applications and environments. Super high strength and durability combine with long-term color retention to deliver a truly versatile outdoor fabric for a variety of applications.

The most balanced and cost-effective fabric available for marine covers and tops, awnings, or other outdoor applications requiring outstanding durability, higher water repellence and excellent breathability.

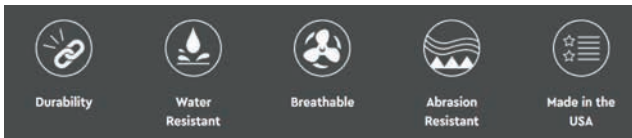

Part No.	Color	Width: mm/in		Av Roll Length: m/yd	
FH080BEIGE	Beige	1520	60	68.5	75
FH080BLK	Black	1520	60	68.5	75
FH080BURG	Burgundy	1520	60	68.5	75
FH080CNV	Captain Navy	1520	60	68.5	75
FH0800FGR	Forest Green	1520	60	68.5	75
FH080GRAPH	Graphite	1520	60	68.5	75
FH0800LCHR	Lite Charcoal	1520	60	68.5	75
FH0800MIST	Mist	1520	60	68.5	75
FH0800MOSS	Moss	1520	60	68.5	75
FH0800OYS	Oyster	1520	60	68.5	75
FH0800PBU	Pacific Blue	1520	60	68.5	75
FH0800ROY	Royal Blue	1520	60	68.5	75
FH0800SAND	Sand	1520	60	68.5	75
FH0800SANH	Sandstone Heather	1520	60	68.5	75
FH0800SAPTW	Sapphire Tweed	1520	60	68.5	75
FH0800SLTH	Slate Heather	1520	60	68.5	75
FH0800SCAR	Scarlet	1520	60	68.5	75
FH0800TAUP	Taupe	1520	60	68.5	75
FH0800TRED	True Red	1520	60	68.5	75
FH0800TST	Toast	1520	60	68.5	75
FH0800WHT	White	1520	60	68.5	75
FH0800YEL	Yellow	1520	60	68.5	75



## Specifications for Weathermax® Fabrics

- ▲ 10 Year Limited Warranty
- ▲ 8.0 oz / yd<sup>2</sup> (271 g / m<sup>2</sup>)
- ▲ No Sagging
- ▲ No Color Bleeding or Rub-Off
- ▲ Easier Handling and Stowing
- ▲ 2X Strength & Durability
- ▲ 6X Abrasion Resistance
- ▲ 50% Higher Water Resistance
- ▲ Twice the Fade Resistance
- ▲ Double the Strength Retention
- ▲ High Water Resistance + High Breathability

## Color Availability



Weathermax 80

Note: Color representation from 4-color process is for reference purposes only. Please inquire for color sample of actual fabric.



# A FULL SERVICE DISTRIBUTOR FOR THE AWNING INDUSTRY. NOW WITH THREE LOCATIONS IN NORTH AMERICA.

### FABRICS:

Sunbrella  
Firesist  
Sattler 745FR  
Sattler 745 Evo  
Weathermax  
Ferrari Light  
Ferrari Top  
Top Gun FR

### HARDWARE:

Pipe & Tubing  
Steel Fittings  
Blocks & Pulleys  
Keder Tape &  
Awning Rope  
Awning Tracks  
Flex-A-Rail II  
Xtreme Seal

### FINDINGS:

Bonded Thread  
Tenara Thread  
YKK Zippers  
Fasteners  
Buckles/Hooks  
Velcro  
Rope & Cord  
Bindings/Braid

### TOOLS:

Hot Knives  
Bendarc  
Crownac  
Shears  
Measures  
Clamps  
Setting Tools  
Dies/Punches



Huntington Beach, CA  
t: (800) 433-0101



Canton, MA  
t: (800) 422-5684



Pompano Beach, FL  
t: (855) 599-7741

[www.bainbridgeintusa.com](http://www.bainbridgeintusa.com)

Full Service Distribution

## Top Gun FR - Flame Retardant Fabric

# TOP GUN<sup>®</sup> FR



- ▲ 100% Polyester awning fabric - acrylic coated.
- ▲ Formerly known as 'Holiday'
- ▲ Super high strength with great abrasion resistance.
- ▲ Dimensionally stable fabric with maximum stretch or shrinkage of less than 1%.
- ▲ UV and mildew resistant.
- ▲ Water repellent, permeable to water vapour but will not trap excess moisture.
- ▲ 5 year manufacturers limited warranty.
- ▲ Meets CA State Fire Marshall 117e, NFPA 701, CPAI-84 and ASTM, E84-84 codes.
- ▲ Uses: Awnings, covers, gazebos, tents, etc.
- ▲ Weight: 407gsm/12oz sq yd.

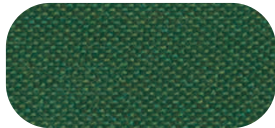

Hunter Green



Silver Grey



Black

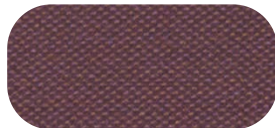

Burgundy

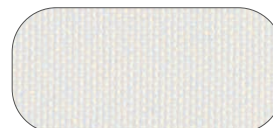

White



Royal Blue



Tan



Ivory



Chocolate Brown



Terracotta

Part No.	Color	Width: mm/in	Av Roll Length: m/yd
F0350A75Y	Burgundy	1570 62	45.7 50
F0350A60Y	Black	1570 62	45.7 50
F0350A97Y	Silver Grey	1570 62	45.7 50
F0350A47Y	Hunter Green	1570 62	45.7 50
F0350A13Y	Ivory	1570 62	45.7 50
F0350A87Y	Ocean Blue	1570 62	45.7 50
F0350A79Y	Royal Blue	1570 62	45.7 50
F0350A00Y	White	1570 62	45.7 50
F0350A35Y	Tan	1570 62	45.7 50
F0350A62Y	Chocolate Brown	1570 62	45.7 50
F0350A71Y	Terracotta	1570 62	45.7 50

Please turn back to pages 28-34 for more information on marine fabrics from Marlen Textiles.



## Marlen Textiles

Note: Color representation from 4-color process is for reference purposes only. Please inquire for color sample of actual fabric.

## SATTLER 745 Evolution



- ▲ PVC Coated Material
- ▲ Matte Varnish - helps to reduce glare
- ▲ 100% Waterproof
- ▲ Graphics Receptive
- ▲ Flame Retardant to: ASTM E 84 CI A, NFPA701, CA-T19
- ▲ REACH Compliant
- ▲ 63"/1600mm width for ease of handling
- ▲ A Multi-Range Product Ideal for:  
Canopies, Tents, Tensile Umbrellas, Shade Structures, Awnings, and many more.
- ▲ 10 Year Limited Warranty
- ▲ 18.9 oz / yd<sup>2</sup> (640.8 g / m<sup>2</sup>)

Sattler 745 Evolution is a flame-retardant, PVC coated textile; specifically designed for the North American markets. It boasts all of the popular new color styles. It comes standard with a matte varnish, accepting multiple type of graphic options. A durable fabric that can be used in more than one type of application, Sattler 745 Evolution gets the job done in the harshest environments.

Produced in Austria, all our fabrics fulfill strictest quality and environmental standards. This is guaranteed by ISO 9001:2015 Quality Management System and ISO 14001:2015 Environmental Management System certificates.



Part No.	Color	Width: mm/in		Av Roll Length: m/yd	
FHE745BRG	Burgundy	1600	63	26.9	29.5
FHE745BLK	Black	1600	63	26.9	29.5
FHE745BRK	Brick	1600	63	26.9	29.5
FHE745COF	Coffee	1600	63	26.9	29.5
FHE745DBU	Directoire Blue	1600	63	26.9	29.5
FHE745GGRN	Galapagos Green	1600	63	26.9	29.5
FHE745GR	Green	1600	63	26.9	29.5
FHE745OBU	Ocean Blue	1600	63	26.9	29.5
FHE745NBU	Navy Blue	1600	63	26.9	29.5
FHE745NWT	Navajo White	1600	63	26.9	29.5
FHE745OLV	Olive Green	1600	63	26.9	29.5
FHE745ORG	Orange	1600	63	26.9	29.5
FHE745QGRY	Quite Gray	1600	63	26.9	29.5
FHE745RBU	Royal Blue	1600	63	26.9	29.5
FHE745RED	Red	1600	63	26.9	29.5
FHE745SGRY	Steel Gray	1600	63	26.9	29.5
FHE745TWL	Twill	1600	63	26.9	29.5
FHE745WHT	White	1600	63	26.9	29.5
FHE745WPEP	White Pepper	1600	63	26.9	29.5
FHE745WHT	White	1600	63	26.9	29.5
FHE745YEL	Yellow	1600	63	26.9	29.5

## Color Availability



### Information

Sattler 745 Evolution®  
Please contact your Sales Representative for the latest card



## Sattler 745 FR Awning Fabric



- ▲ Flame retardant, PVC coated polyester membrane.
- ▲ Meets NFPA 701, CPAI-84, CSFM Title 19, CPAI-84, BS7837, CAN/ULC-S109, NFB 92-507
- ▲ Excellent self cleaning effect due to high-gloss acrylate top varnish coating.
- ▲ High level of adhesion for strong welding seams.
- ▲ Width: 98"/2500mm
- ▲ Weight: 641gsm/18.9oz sq yd.
- ▲ Uses: Fixed awnings, Light structures, Canopies, Tents, Partition curtains etc.
- ▲ Eight Year Limited Warranty.

Part No.	Color	Width: mm/in		Av Roll Length: m/yd	
F745BLKFR	Jet Black	2500	98	45.7	50
F745CBUFR	Cobalt Blue	2500	98	45.7	50
F745CHOFR	Chocolate Brown	2500	98	45.7	50
F745GRNFR	Moss Green	2500	98	45.7	50
F745GYFR	Road Grey	2500	98	45.7	50
F745MOCFR	Mocca	2500	98	45.7	50
F745MOWTFR	Oyster White	2500	98	45.7	50
F745MOGRFR	Opal Green	2500	98	45.7	50
F745DBUFR	Deep Blue	2500	98	45.7	50
F745REDFR	Ruby Red	2500	98	45.7	50
F745WTFR	White	2500	98	45.7	50



Black



Cobalt Blue



Chocolate Brown



Moss Green



Road Grey



Mocca



Ruby Red



White

Sattler 745 FR

### When the job demands a tough, flame retardant and weatherproof, performance fabric.

## 745 FR / 98"

**Flame Retardant and Weatherproof**

Sattler's new 745FR is a flame retardant PVC-coated membrane, especially adapted to U.S. market requirements. It boasts top features such as a high gloss top varnish which ensures best self-cleaning properties and protects the fabric against aging. A strong polyester base fabric combined with an adequately thick, knife-coated PVC layer gives you the fabric you need for those heavy duty applications.

Produced in Austria, all our fabrics fulfill strictest quality and environmental standards. This is guaranteed by ISO 9001:2001 Quality Management System and ISO 14001:2004 Environmental Management System certificates.

**Applications:**

- light structures
- fixed awnings
- canopies
- tents
- partition curtains

**Features:**

- excellent durability with 18.9oz/sqyd
- efficient standard width of 98 inches (on request up to 125 inches width possible, please ask for minimum quantities)
- excellent self-cleaning effect due to high-glossy acrylate top varnish (on request weldable or non-weldable PVDF-varnish possible, please ask for minimum quantities)
- excellent UV-resistance, color- and weatherfastness
- perfect flatness of fabric panels, therefore easy to handle in welding process
- excellent adhesion for strong welding seams
- warranted quality

Note: Color representation from 4-color process is for reference purposes only. Please inquire for color sample of actual fabric.

## Awning Pipe & Tubing

GATORSHIELD top quality awning products are available in a wide variety of sizes and gauges.

- ▲ GATORSHIELD is a superior, triple layer rust & corrosion resistant product.
- ▲ Coatings of zinc, chromate & then a clear polymer are applied for maximum durability.
- ▲ Interior surfaces also have a corrosion resistant coating.



G556\*



G550/0500



G550/0625



G550/0815



G550/1029

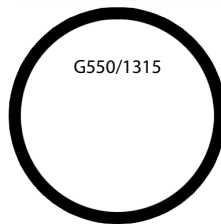

G550/1315

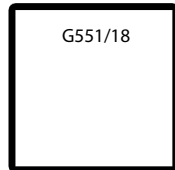

G551/18



G551/16

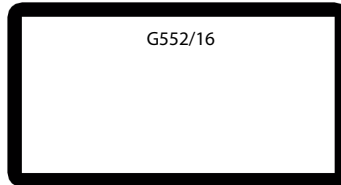

G552/16



G554/15

Note: G556 is not a Gatorshield product

Part No.	Description	Size	Gauge	Length: m/ft	
G556*	Solid Rod	.500 OD	Solid	6	20
G550/0500	1/2" Head Rod	.500 OD	18 ga	6	20
G550/0625	3/8" Tie Down	.625 OD	16 ga	6	20
G550/0815	1/2" Round	.815 OD	15 ga	6	20
G550/1029	3/4" Round	1.029	14ga	6	20
G550/14	1" Round	1.315 OD	14 ga	6	20
G551/16	1" x 1" Square	1"	16 ga	6	20
G551/18	1" x 1" Square	1"	18 ga	6	20
G552/16	1" x 2" Rectangle	1" x 2"	16 ga	7.3	24
G554/15	2" x 2" Square	2" x 2"	15 ga	7.3	24

Note: End profile illustration above is for reference purposes only and not to be used for measurement/comparisons etc.



WSZ031



WSZ032



Part No.	Finish	Pack Qty
WSZ031	Single Awning Pulley	100
WSZ032	Double Awning Pulley	100
WSZ401	Swivel Eye Single Pulley-Stamped Steel 3/16" Rope	100



WSZ101



WSZ007



WSZ001



## Aluminum Awning Fittings

LITCO Premium cast aluminum awning

- ▲ Cast from an alloy that is best suited
- ▲ Smooth surface with a bright finish.



## Steel Zinc Awning Fittings

A high quality line of rust resistant awning fittings.

- ▲ Products are Zinc Die Cast or Stamped Steel - hot dipped, galvanized or galvanized malleable iron.
- ▲ Stainless Steel square head screws ensure a secure attachment.



Part No.	Finish	Pack Qty
WA122	Aluminum #2 Cleat - 6"	100
WA130	Aluminum #2 Camel Back Hinge 3/4"	100
WA140	Aluminum 1" Slip Fit Eye End	25
WA145	Aluminum 1" Rafter & Front Bar Clamp Fitting	25
WA160	Aluminum Tie Down Clamp	25
WA171	Aluminum Slip Fit Elbow	25
WA172	Aluminum Single Hole Head Rod Clamp	100
WA202	Aluminum #2 Head Rod Clamp	100
WA204	Aluminum 1" Post Hole Socket	25
WA204	Aluminum 1" Post Socket - Two Wood Screws	25

Part No.	Finish	Pack Qty
WSZ001	Zinc Steel "Z" Bracket	250
WSZ007	Zinc Steel "U" Bracket	100
WSZ101	Zinc Steel #1 Cleat - 4"	100
WSZ122	Zinc Steel #2 Camel Back Hinge	100
WSZ130	Zinc Steel 1" Slip Fit Eye End	25
WSZ140	Zinc Steel 1" Tee Adjustable Front Bar Fitting	25
WSZ142	Zinc Steel Front Bar Clamp	25
WSZ145	Zinc Steel Tie Down Clamp	25
WSZ147	Zinc Steel 1" Tie Down Clamp	25
WSZ160	Zinc Steel Slip Fit Elbow	25
WSZ171	Zinc Steel Single Hole Head Rod Clamp	25
WSZ172	Zinc Steel #2 Head Rod Clamp	25
WSZ175	Rod & Rafter Holder	25
WSZ202	Zinc Steel 1" Post Hole Socket	25
WSZ203HD	Zinc Steel H/D 1" Post Hole Socket	25
WSZ301	Zinc Steel 1" Pipe Clamp	100

Awning Track and Keder are now featured on pages 64 & 65. Please call for more information.



## Keder Tape

- ▲ Durable woven polyester tape welded to a polyethylene core.
- ▲ Sold in 100m/328' reels.
- ▲ Cut yardage available at a surcharge.
- ▲ Available in two sizes.
- ▲ White or Black.
- ▲ Split tail version also available.

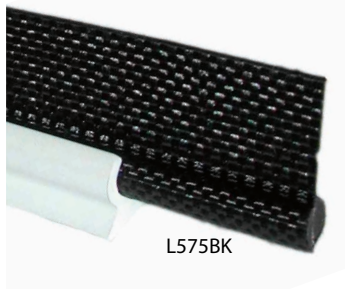

L575BK

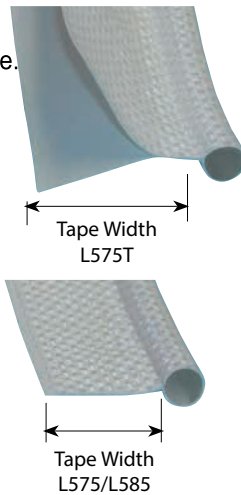

Part No.	Color	Diameter: mm/in	Tape Width: mm/in	Use With
L555	White	5.5 7/32	20 3/4	G535/95
L575	White	7.5 9/32	20 3/4	G512
L575T	White	7.5 9/32	25 1	G512
L575BK	Black	7.5 9/32	20 3/4	G512
L585	White	8.5 1 1/32	20 3/4	G515/G530/G541
L585BK	Black	8.5 1 1/32	20 3/4	G515/G530/G541

## Vinyl Extruded Awning Rope

- ▲ Awning rope is supplied on 30.5m/100 foot reels.
- ▲ Not for Flex-A-Rail.
- ▲ Cut lengths will be surcharged.



Part No.	Diameter: mm/in	Tape Width: mm/in	Color
L520	6.3 1/4	20 3/4	White

## Awning Welt Cord

- ▲ 1/4" Welt cord, made from HARD POLY TUBING
- ▲ Does not rot or mildew.
- ▲ Make your own custom welt to match your fabrics.
- ▲ Sold only in 1000ft/304m reels.



Part No.	Color	Width: mm/in	Av Roll Length: m/ft
E494	White	6.35 1/4"	304/1000

## 3M VHB Attachment Tape

- ▲ High performance acrylic adhesive.
- ▲ Medium density white acrylic foam tape.
- ▲ Adhesive on both sides with red release liner.
- ▲ Use: Attaching automotive and marine trim, awning track, flex a rail.



Part No.	Width: mm/in	Roll Length: m/yd	Case Qty
J112V	12.7 1/2	18 20	12
J117V	22.5 7/8	18 20	12



Warning: Always test adhesive bond strength for your material and application.

## Keder Track Slide

- ▲ Allows quick and easy installation to many awning tracks.
- ▲ New ball-end design to suit both aluminium and vinyl track (not Flex-a-Rail).
- ▲ Potentially removes the need for awning ropes.
- ▲ Ideal for making curtains that open and close.
- ▲ Ball end fits 3/8" internal diameter.



Part No.	Color	Pack Qty
A091WT	White	100

## HD Vinyl Awning Track

- ▲ UV stabilized PVC construction.
- ▲ Keder track can be sewn on.
- ▲ Compatible with L585 Keder or most BI awning ropes and Keder tapes.



G530

Part No.	Color	Internal Diameter: mm/in	Track Length: mm/ft
G530	White PVC	9mm 3/8	4850 16
G530OW/20	Off White PVC	9mm 3/8	6062 20
G537WT-95	White PVC (180 Degree)	9mm 3/8	2425 8

## Aluminum Awning Track

- ▲ Bright polished aluminum awning track.
- ▲ Compatible with most BI awning ropes and Keder tapes.
- ▲ Use pan head screws to install.
- ▲ Use with L585 Keder tape.



Part No.	Color	Internal Diameter: mm/in	Track Length: mm/ft
G520	Anodised Aluminum	9 3/8	4850 16
G520-8	Anodised Aluminum	9 3/8	2425 8

## Cover Trax System

Unique low profile awning rail system with polyester awning rope and sliding screw cover panel to hide attaching screws.

- ▲ Premium grade extruded PVC with UV inhibitors.
- ▲ Sleek and ultra low profile.
- ▲ Can be used for mounting enclosures, curtains etc.
- ▲ Use with L555 Keder tape.



Part No.	Description	Length: mm/in	
G535WT/95	White Cover Trax System Includes Awning Track and Screw Cover Panel	6100	20
G534-95HD	Heavy Duty Cover Trax	2400	94.5

## Heavy Duty Center Mount Track

- ▲ Increased PVC profile allows extra load capability for large covers, bimini and track to track enclosures.
- ▲ Can be heat formed to most radius.
- ▲ Large channel opening allows use of large Stainless Steel No.6 oval head screws for more secure attachment.
- ▲ Deeper screw trough base design allows for use of L585 8.5mm Keder with sufficient clearance of screw heads.
- ▲ G517WT/16 fits curved surfaces - tubing etc.

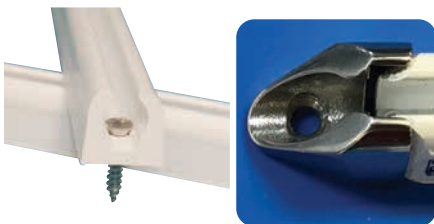

G515WT/24

G724S

Part No.	Description	Length: mm/ft	
G515WT/24	White HD Center Mount Track	7275	24
G515OW/24	Off White HD Center Mount Track	7275	24
G515BK-24	Black HD Center Mount Track	7275	24
G517WT/16	White HD Concave Center Mount Track	4850	16
G724S	Costa Stainless Steel Track Cap		

## Vinyl Keder Track

- ▲ UV stabilized PVC construction.
- ▲ Keder track can be sewn on.
- ▲ Compatible with L585 Keder or most Bainbridge awning ropes and Keder tapes.



G541WT/8

Part No.	Color	Internal Diameter: mm/in	Track Length: mm/ft	
G541WT-8	White PVC	9 $\frac{3}{8}$	2438	8
G546T-10	White PVC/Twin Track	9 $\frac{3}{8}$	2987	9.8

## Flex-A-Rail II Awning Track

- ▲ Flexible, non-corrosive, extruded PVC track for BI awning ropes.
- ▲ Works best with L575 & L575BK.
- ▲ Highly flexible for easy installation.
- ▲ Use flat or oval head screws to install (D371 or D355).
- ▲ Use 3M VHB tape to help install Flex-A-Rail.

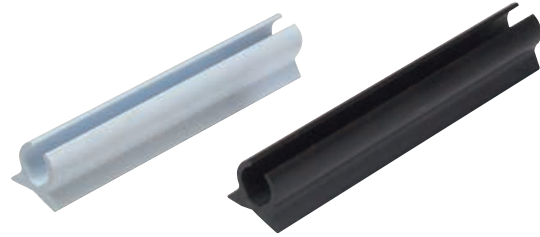

Part No.	Color	Internal Diameter: mm/in		Track Length: mm/ft	
G512	White PVC	8	$\frac{5}{16}$	2300	7'6"
G512-15	White PVC	8	$\frac{5}{16}$	4600	15'
G512BK	Black PVC	8	$\frac{5}{16}$	2300	7'6"

## Stainless Steel Screws for Attaching Track

- ▲ Use to attach Flex-A-Rail, Cover Trax and other types of awning track.
- ▲ Screws are sold in full packs of 100.

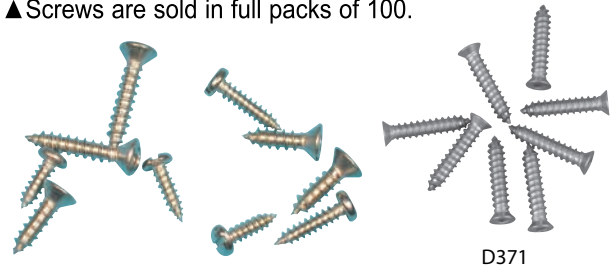

D371

Part No.	Size: mm/in	Style	Head
D350	No. 4 x $\frac{3}{8}$ (10)	Self Tapping	Pan
D351	No. 4 x $\frac{1}{2}$ (12)	Self Tapping	Pan
D353	No. 6 x $\frac{1}{2}$ (12)	Self Tapping	Pan
D355	No. 6 x $\frac{1}{2}$ (12)	Self Tapping	Flat
D352	No. 6 x $\frac{3}{8}$ (10)	Self Tapping	Pan
D372	No. 6 x $\frac{3}{4}$ (19)	Self Tapping	Flat
D373	No. 6 x $\frac{3}{4}$ (19)	Self Tapping	Oval
D371	No 4 Head with No 6 Body 19mm/ $\frac{3}{4}$ inch	Self Tapping	Square

## Square Head Screwdriver

- ▲ Use with D371 square head screws.
- ▲ Narrow shaft will NOT scratch Flex-a-Rail.

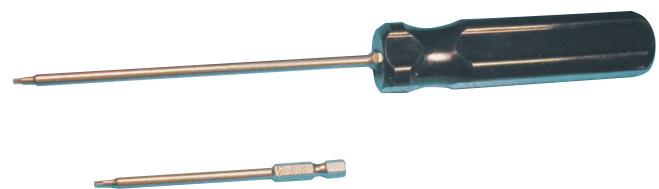

Part No.	Description
C335	Size 0 Square Head Screwdriver
C336	Size 0 Square Head Screwdriver Bit

## Xtreme Seal®

Xtreme Seal edge seal is a closed-cell, flexible material that can be glued or sewn to most materials and surfaces.

- ▲ Edge seal creates a three-point contact seal on most surfaces.
- ▲ Perfect choice as an edge seal on all types of custom covers.
- ▲ Can be used on convertible tops, side curtains, windshield tops, radar arches and awnings.



L710BK



L710WT

Part No.	Color	Edge Seal Width: mm/in		Length: m/ft	
L710BK	Black	50	2	15	50
L710WT	White	50	2	15	50

## Xtreme Pro Seal®

Pro Seal is a dual durometer exclusive to Xtreme Seal. This ground breaking edge seal is soft foam at the seal side and flat on the sewing side, so it can be sewn under the binding for a perfect seal.

- ▲ Provides an excellent seal.
- ▲ Black Only.



L718BK

Part No.	Color	Edge Seal Width: mm/in		Length: m/ft	
L718BK	Black	28	1 1/8	30	100

## Ultra Seal®

This new profile is designed for a great edge seal. Works well with commonsense fasteners and giving a flatter finished profile.

- ▲ Designed for a great edge seal.
- ▲ Black Only.

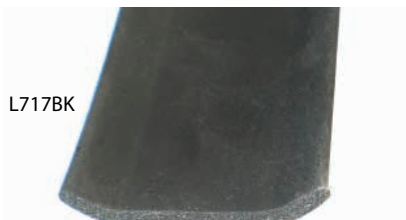

L717BK

Part No.	Color	Edge Seal Width: mm/in		Length: m/ft	
L717BK	Black	45	1 3/4	30	100

## Xtreme Awning Seal®

For the awning manufacture that is looking for the best seal and ease of installation. A self adhesive tape makes for a fast installation.

- ▲ Ideal for awning manufacturers.
- ▲ Provides the best seal available.
- ▲ Easy installation with 3M self-adhesive backing.

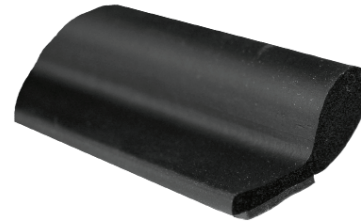

L712BK

Part No.	Color	Edge Seal Width: mm/in		Length: m/ft	
L712BK	Black	28	1 1/8	30	100

## Xtreme V Seal®

V Seal is the perfect choice for tight corners, bow covers and smaller cutouts, anywhere an edge seal is needed with a smaller profile but still has a water penetration problem.

- ▲ The ideal choice for small cutouts and tight corners.
- ▲ Perfect for bow covers and radar arch cutouts.



L715VBK

L715VWT

Part No.	Color	Edge Seal Width: mm/in		Length: m/ft	
L715VBK	Black	20	7/8	30	100
L715VWT	White	20	7/8	30	100

## Spray Welt with Adhesive

Functional spray welt manufactured from extruded foam rubber. Ideal for almost all applications where a tight, waterproof seal is required.

- ▲ P-section design ensures maximum efficiency.
- ▲ Durable extruded foam rubber composition.
- ▲ Hi-tack adhesive with release paper on rear.
- ▲ Economical 15m/50 ft reels.
- ▲ This product is ideal weather strip for sealing: enclosures, dodgers, covers etc.



L705BKA

Part No.	Color	Edge Seal Width: mm/in		Length: m/ft	
L705BKA	Black	34	1 1/8	15	50



**MADE IN THE USA**

Side curtains snapped DOT on horse drawn buggies.



The Tin Lizzie meant more applications for DOT.

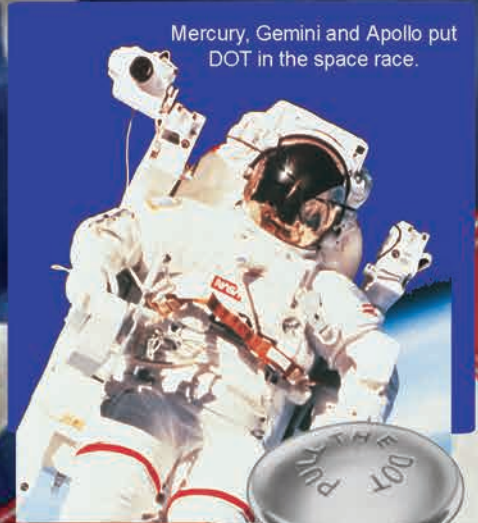

Mercury, Gemini and Apollo put DOT in the space race.



Football helmets snap with DOT from the sandlot to Superbowl.



Since WWI military applications have snapped with DOT.



DOT sails the seven seas and the oceans of the world.



**LIFT-THE-DOT<sup>®</sup> COMMON SENSE<sup>®</sup> PULL-THE-DOT<sup>®</sup> DURABLE<sup>™</sup>**

**100 Years of Quality Stamped in History**

## Button Snap Fastener

When superior snap action and holding strength is needed, the durable DOT fastener is the one to use, it is self-piercing, so no pre-punching is required, the durable DOT fastener's heavy-duty construction assures a firm grip that will remain secure through years of use.

- ▲ All manufactured in nickel plated brass.
- ▲ May be used with Quick-Fit locating tools.
- ▲ Available only in full packs of 100.



G140



G142, G155



G143



G145

Part No.	Description	Mfr #
G140	Nickel Button with 5mm/ 3/16" Barrel	93-X2-10128
G140BU	Pacific Blue Enamel Button with 5mm/ 3/16" Barrel	93-XV-10150
G140BK	Black Enamel Button with 5mm/ 3/16" Barrel	93-XV-10150
G140WT	White Enamel Button with 5mm/ 3/16" Barrel	93-XV-10150
G140NV	Navy Enamel Button with 5mm/ 3/16" Barrel	93-XV-10150
G141	Nickel Button with 6.5mm/ 1/4" Barrel	93-X2-10127
G141L	Nickel Button with 10mm/ 3/8" Barrel	93-X2-10112
G142	Regular Action Socket	93-XB-10224
G145	Eyelet with 6.5mm/ 1/4" Barrel	93-BS-10412
G146	Eyelet with 8mm/ 5/16" Barrel	93-BS-10413
G147	Eyelet with 10mm/ 3/8" Barrel	93-BS-10414
G155	Stiff Action Socket	93-XX-10224
G140BKM	Matte Black Enamel Button with 5mm/ 3/16" Barrel	93-XV-10150
G140CGY	Charcoal Grey Enamel Button with 5mm/ 3/16" Barrel	93-XV-1050
G140HBG	Heather Beige Enamel Button with 5mm/ 3/16" Barrel	93-XV-10150
G140TST	Toast Enamel Button with 5mm/ 3/16" Barrel	93-XV-10150

## Button Snap Fastener Specialty Studs

- ▲ All manufactured in nickel plated brass/stainless steel.
- ▲ Available only in full packs of 100.



Part No.	Description	Mfr #
G143	Stud for use with Eyelet	93-BS-10370
G144	Deep Stud	93-BS-10379
G174	Rivet Stud 3.2mm/ 1/8"	93-10314
G148	Stud, Reversible Type (use with G142)	93-XB-10342
G156	20mm/ 3/4" Windshield Clip	93-10388
G157	28.6mm/ 7/8" Windshield Clip	93-10391
G158	Windshield Stud Clip	-
G182	Flangeless Stud	93-10373

## Stainless Steel Button Snap Fastener

- ▲ The new all stainless steel DOT Buttons are stronger than the standard brass/nickel buttons, and resist corrosion.
- ▲ The stainless steel barrels allows it to self-pierce through a greater variety and thickness of material without the need for pre-punching.
- ▲ The brass/nickel plated cap with stainless steel style self-pierces through nylons, Dacrons and webbings.
- ▲ Available only in full packs of 100.



G142SS/G149SS



G143SS



G140SS



G145SS

Part No.	Description	Mfr #
G140SS	S.S. Button with 4.8mm/ 3/16" S.S. Barrel	93-XN-10128
G140BS	Brass/Nickel Button with 4.8mm/ 3/16" S.S. Barrel	93-XB-10128
G141SS	S.S. Button with 6.4mm/ 1/4" S.S. Barrel	93-XN-10128
G142SS	S.S. Regular Action Socket	93-XN-10224
G143SS	S.S. Stud for use with Eyelet	93-NS-10370
G145SS	S.S. Eyelet with 6.5mm/ 1/4" Barrel	93-NS-10412
G149SS	Easy Action S.S. Socket	93-XN-10225

## Button Snap Fastener Screw Studs

- ▲ Manufactured in nickel plated brass.
- ▲ Available only in full packs of 100.
- ▲ Screws in brass or stainless steel.



G151  
G151SS



G152OS



G153  
G154



G171FW



G171  
G175



G083TWT

Part No.	Description	Mfr #
G152OS	Stud with Oversize S.S. Screw (#10 Deep Phillipsx15.9mm/ 5/8")	93-10934
G151	Stud with 10mm/ 3/8" Phillips Head Screw (#8)	93-X8-103934-12
G151SS	Stud with S.S. 10mm/ 3/8" Phillips Head Screw (#8)	93-XN-103934-12
G152	S.S. Stud with 15mm/ 5/8" Phillips Head Screw (#8)	93-X8-103937-20
G153	Stud w. Phillips Head (#10-32 Brass Machine x 9.5mm/ 3/8")	93-XB-10708-12
G154	Stud w. Phillips Head (#10-32 Brass Machine x 15.9mm/ 5/8")	93-XB-10708-20
G171	Self-Drilling S.S. Screw (#8 Deep Phillips Head x 12.7mm/ 1/2")	93-10301-14
G175	Self-Drilling S.S. Screw (#8 Deep Phillips Head x 20mm/ 3/4")	93-10301-20
G171FW	Plastic Flexi-Washer for Eyelet, Button or Studs	
G083BLK	Snapit Screw Black 1/4-20	
G083TWT	Snapit Screw White 1/4-20	

### Pull-the-Dot Fasteners

- ▲ A heavy duty, three sided locking snap fastener that is built to withstand extreme pressure on three sides without unlocking.
- ▲ When pulled on the fourth side where the Pull-the-Dot trademark appears, the fastener releases instantly.
- ▲ DOT fasteners are sold in full packs of 100 only.



Part No.	Description	Mfr #
G170	Pull-the-Dot Button Cap	92-XE-18100
G172	Pull-the-Dot Socket	92-XX-18201
G173	Pull-the-Dot Stud	92-BS-18303
G176	Pull-the-Dot Screw Stud	92-18307
G145	6.4mm/ 1/4 " Post	93-BS-10412
G146	7.0mm/ 9/16 " Post	93-10413

Note: Special tools are required for Pull-the-Dot G170, G172 and G173.

### Quick-Fit Canvas Tools

- ▲ Quick-Fit holding tools snap onto existing studs and provide a quick and easy way to hold material while fitting boat covers. Plastic holding cap fits onto the pin, holding the material in place.
- ▲ Quick-Fit tools may be used over and over.
- ▲ Great for fitting with material and also holding paper or plastic material patterns.
- ▲ Accurately mark the cover where sockets are placed.
- ▲ Use on tonneau covers, cockpit covers, side curtains, enclosures, biminis, dodgers, etc...
- ▲ Kit contains 50 fit pins, 25 holding caps and 1 release

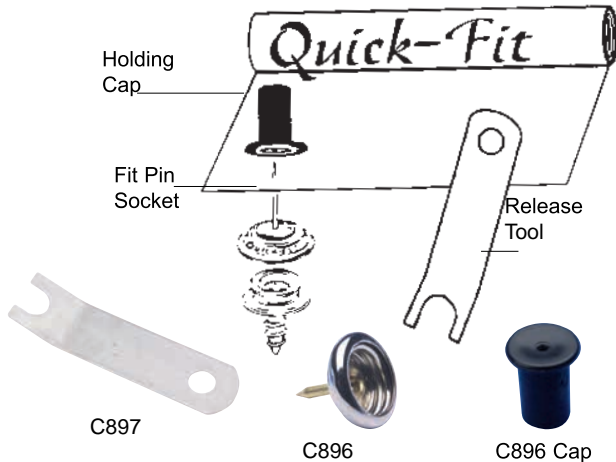

Part No.	Description	Pack Qty
C896CAP	Plastic Holding Cap	each
C896	Fit Pin Socket	50/box
C897	Release Tool	each
C896KIT	Kit	each

### YKK SNAD Fasteners

- ▲ Unique 25mm & 40mm low profile design.
- ▲ Aggressive VHB adhesive pad on rear to attach to hull etc.
- ▲ Versions available to attach to button sockets or studs.
- ▲ Impact and UV resistant.
- ▲ Note: Prepare surface for best adhesion.



Part No.	Description	Fastener
G190BK	Black 40mm YKK Dome Adhesive Fastener - Stud	G143/G155
G190WT	White 40mm YKK Dome Adhesive Fastener - Stud	G143/G155
G191BK	Black 40mm YKK Dome Adhesive Fastener - Socket	G143
G191WT	White 40mm YKK Dome Adhesive Fastener - Socket	G143
G192BK	Black 25mm Flexible Adhesive Fastener - Stud	G143
G192CLR	Clear 25mm Flexible Adhesive Fastener - Stud	G143
G192WT	White 25mm Flexible Adhesive Fastener - Stud	G143
G193CLR	Clear 40mm Flexible Adhesive Fastener - Stud	G143
G194BK	Black 25mm YKK Adhesive Dome Fastener - Stud	G142/G143
G194WT	White 25mm YKK Adhesive Dome Fastener - Stud	G142/G143

### Vadney Clip

- ▲ Unique split design allows fitment of a screw stud without drilling into frame
- ▲ Short version available for shallow tracks.
- ▲ Available in black only.
- ▲ Sold in packs of 100 pieces.



Part No.	Description	Use With Fastener
G052BK	Vadney Clip - Standard	G151, G106, G115S, G167
G053BK	Vadney Clip - Short	G151, G106, G115S, G167

## Commonsense Turnbutton Fastener Studs

Traditional fastenings for boat and marine covers and canvas work. Recommended for incorporating secure fastening combined with easy access.

- ▲ All manufactured in nickel plated brass.
- ▲ Available only in full packs of 100.



Part No.	Description	Mfr #
G100	Single Stud with 2 Screw Base	91XB78322
G101	Double Stud with 2 Screw Base	91XB78323
G103A	Single Stud with 2 Prong Fastener Stud	91XB78332
G102A	Double Stud with Two Prongs	91XB78333
G103BP	Clinch Plate for Studs with Two Prongs	91BS78507
G106	Single Stud with Brass Screw (No.7 x 15mm/ 5/8")	91XB783247
G106S	Single Stud with Stainless Steel Screw (No.7 x 15mm/ 5/8")	91XB783247
G107	Double Stud with Brass Screw (No.7 x 15mm/ 5/8")	91XB78325
G107/25	25 Pk Double Stud with Brass Screw (No.7 x 15mm/ 5/8")	91XB78325
G108	Single Stud with Rivet Base	91BS78317
G108BP	Backplate for Rivet Base	91BS78502
G101FW	Flexiwasher for G100/G101	91BS78522

## Commonsense Turnbutton Fastener Eyelets

- ▲ All manufactured in nickel plated brass.
- ▲ Available only in full packs of 100.

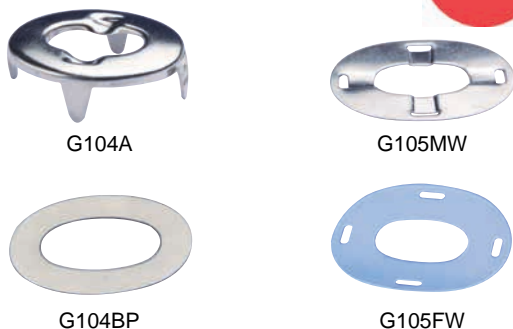

Part No.	Description	Mfr #
G104A	Eyelet with Regular Prongs	91BS78403
G105A	Eyelet with Long Prongs	91BS78404
G104BP	Washer for G104A/G105A	91BS78505
G105MW	Metal Washer for Eyelet	91BS78510
G105FW	Plastic Flexi-washer for Eyelet	91PS78511

## Lift-the-Dot® Fastener Studs

- ▲ All manufactured in nickel plated brass.
- ▲ Available only in full packs of 100.



Part No.	Description	Mfr #
G110	Single Stud with 2 Screw Base	90X316347
G120A	Rivet Stud	90XB16358
G120BP	Washer for Rivet Stud	90BS16509
G119A	Single Stud with Two Prong	90BS16349
G119BP	Clinch Plate for G119A	90BS16501
G113	Stud with Machine Brass Screw	90XB16362-12
G115S	Stud with 10mm/ 3/8 " Stainless Steel Screw	90XB16360-12
G116S	Stud with 15mm/ 5/8 " Stainless Steel Screw	90XB16360-20
G103BP	Clinch Plate for Stud with 2 Prongs	91BS78507
G117	3/4 " Windshield Clip	90X816376
G118	7/8 " Windshield Clip	90X816377

## Lift-the-Dot® Fasteners

- ▲ All manufactured in nickel plated brass.
- ▲ Available only in full packs of 100.

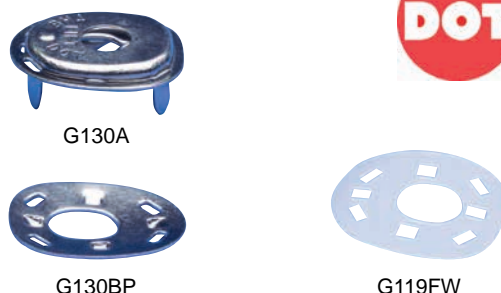

Part No.	Description	Mfr #
G130A	Regular Socket	90XX16205
G130LP	Long Prong Socket	90XX16206
G130BP	Clinch Plate for Socket	90BS16506
G119FW	Plastic Flexi-washer for Eyelet	90BS16510



### Commonsense Cutting Punches

▲ To prolong life of tool, use a mallet and a cutting pad.

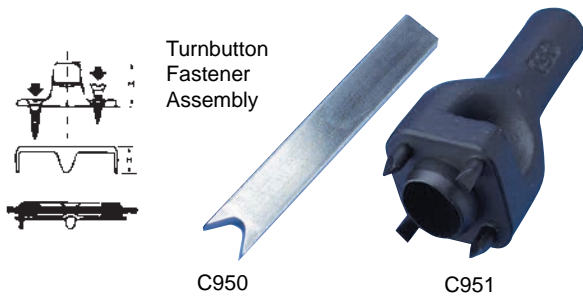

Part No.	Description	Fastener
C950	Cutting Punch	G102A/G103A
C951	Heavy Duty Cutting Punch	G104A/G105A

### Common Sense Fastener Tools

Fastener Part #.	Hand Tool Part No.
G102	C950
G103	C950
G104	C951 or C136
G105	C951 or 136

### Commonsense Hand Setting & Drill Tools

▲ Ideal for hand setting G106 & G107 studs.



Part No.	Description
C957HAND	Hand Setting Tool For G106/G107
C957DRL	Drill Mount For Holding G106/G107

### Tylaska Snap Setter

A new die solves the problem of setting two fasteners at once, by having two precisely spaced cavities allowing two buttons or eyelets to be installed at the same time.

- ▲ Time saving tool.
- ▲ Made from heat treated chrome-moly aerospace steel.
- ▲ One side is for 2 x G140 buttons & the other for 2 x G145



Part No.	Description
C959	Button and Eyelet Tool

### Lift-the-Dot® Tools

▲ To prolong life of tool, use a mallet and a cutting pad.



Part No.	Description	Fastener
C950	Cutting Punch	G119A
C952	Hand Set Hex Head	G113/115S/116S
C953	Cutting Punch	G130A

### Tools For Use With Lift-the-Dot Fasteners

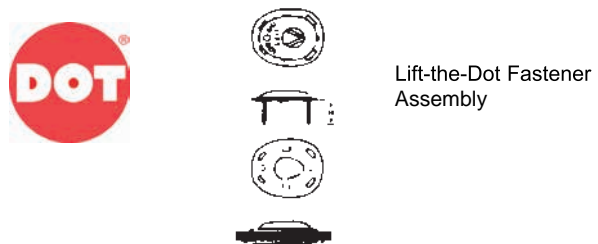

Fastener Part No.	Bench Press Tool Part No.	Hand Tool Part No.	Press-N-Snap
G113	-	C952	-
G115	-	C952	-
G116	-	C850	-
G119	-	C952	-
G120	C944A	-	C368
G120A	C944B	-	C369

### Tools For Use With Button Snap/ Durable Dot Fasteners



Fastener Part #.	Bench Press Tool Part #	Hand Tool Part #	Press-N-Snap
G140	C941A	C954/C955	C361
G141	C941A	C954/C955	C361
G142	C941B	C954/C955	C361
G143	C942A	C954/C955	C361
G145	C942B	C954/C956	C361
G146	C942B	C954/C956	C361
G147	C942B	C954/C956	C361
G148	-	-	C474

DOT Fasteners

## Snapmaster M840

- ▲ The DOT Snapmaster M840 hand-operated attaching press for snap fasteners offers many features of larger and heavier bench and foot presses, yet is portable and comes in a carrying case. Specialized dies enable the user to pre-punch the BS78403, BS78505 eyelets and washer for Common Sense fasteners as well as setting Button fasteners.
- ▲ The Snapmaster is a rugged tool of all aluminum and steel construction with a warranty direct from the manufacturer.



Part No.	Description
C930	Snapmaster M840 - Use with Only Snapmaster Dies

### Dies for the Snapmaster M840



Part No.	Mfg #	Description	Use With
C931A	4103	Common Sense Top Punch	G104A/G104BP
C931B	4203	Common Sense Bottom Punch	G104A/G104BP
C932A	4403	Button Snap Top Setting Die	G140/G141
C932B	4303	Button Snap Bottom Setting Die	G142/G155
C933A	4304	Button Snap Top Setting Die	G143
C933B	4404	Button Snap Bottom Setting Die	G145
C934A	4101	Lift-the-Dot Top Punch	G130A
C934B	4201	Lift-the-Dot Bottom Punch	G130BP

## Bench Press

- ▲ Deep throat and long padded handle improves leverage.
- ▲ Easily sets snap fasteners or self-piercing grommets.
- ▲ Light weight aluminum - ideal for portable applications where strength and weight savings are critical.
- ▲ Bench press machine will accept most dies with a 9.5mm/ 3/8 inch shank.



Part No.	Material	Throat Depth mm/in	Approx Weight lbs	Use With Dies
C620	Steel	121 4 3/4	12	C941-5

### Die Tools for use with Bench Press

- All dies have 9.5mm/ 3/8 inch diameter shank.



Part No.	Die	Mfg #	Use With
C941A	Top	1401	G140/G170 - Button
C941B	Bottom	1410	G142/G155/G172 - Socket
C942A	Top	1412	G143/G173 - Stud
C942B	Bottom	1407	G145/G146/G147 - Eyelet
C944A	Top	1456	G120 - Rivet Stud
C944B	Bottom	1457	G120 - Rivet Stud
C938	2 pc Die Set	-	Snapfast Fastener

### Press-N-Snap Tool

- ▲ A hand action tool for closing grommets, rivets and setting button snap fasteners.
- ▲ C360 tool comes complete with die sets for both No1 washer grommets and button snaps.

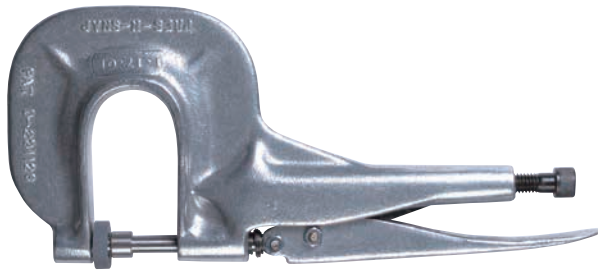

Part No.	Description	Fastener
C360	Press-N-Snap Tool	G140/147,

### Vise Pliers and Attachments

- ▲ C371 - Four piece set.



C370

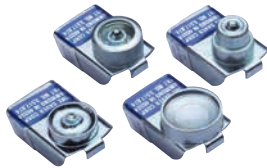

C371

Part No.	Description	For Use With
C370	Vise Pliers	C371
C371	Die Set for Button Snap Fasteners	G140/7

### Dies For Self-Piercing Grommets

- ▲ Self holding Press-N-Snap grommet dies for use with self-piercing grommets and washers.
- ▲ Two piece sets.



Part No.	Size	Mfg #
C366	Size 1, D101 or D111	230
C367	Size 2, D102 or D112	250

### Dies for Press-N-Snap Tool

- ▲ C361 - Four piece set.
- ▲ C362/363 - Two piece sets.

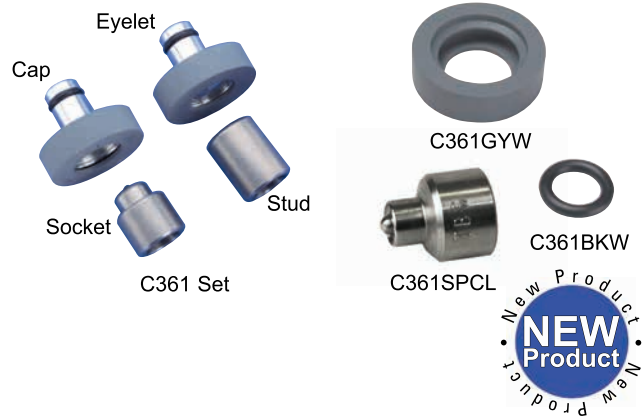

Part No.	Description	For Use With
C361	Button Fasteners, Set (Includes 1 Washer Grommet set)	G140/7
C361SPCL	Special Narrow Socket Die For	
C362	No 0 Spur Grommet, Set	D003
C363	No 1 Spur Grommet, Set	D004
C361GYW	Spare Gray Washer	
C361BKW	Spare Black "O" Ring	
C368	Die for L-T-D Washer #8	G120BP
C369	Die for L-T-D Stud #58	G120A
C374	Die for Gypsy Stud #22	G148
C376	Die Set for Turnbutton Single Stud with Rivet Base	G108/G108BP
C378	Pull The Dot Socket Die	G172

## Stayput Fasteners

- ▲ Stayput fasteners are manufactured from UV stabilized nylon with nickel plated brass tabs and pivot pins.
- ▲ G850 - Horizontal single stud with two screw base. Works with No 1 spur or No 2 plain grommet.
- ▲ G852 - Vertical single stud with two screw base. Works with No 1 spur or No 2 plain grommet.
- ▲ G854 - Fitted through fabric or through a grommet.



Part No.	Description	Color	Pack Qty
G850	Horizontal Stud	White	100
G852	Vertical Stud	White	100
G854	Canvas-to-Canvas	White	100
G850SS	Horizontal Single	Stainless Steel	Each
G852SS	Vertical single	Stainless Steel	Each

## Snapfast

- ▲ Non-corrosive directional fastener.
- ▲ Unlocks in one direction.
- ▲ Stainless steel pronged cap self-pierces most fabrics.
- ▲ Install covers onto fiberglass, wood or other hard surfaces with no. 8 screw.
- ▲ Stud attaches to fabric with long eyelet.



Part No.	Description	Color	Pack Qty
G061	Stainless Steel	-	100
G061LP	Stainless Steel	-	100
G062BK	Socket	Black	100
G062WT	Socket	White	100
G063BK	Stud	Black	100
G063WT	Stud	White	100
C938	2 pc Bench Press Die Set	-	-



## Permalock Fasteners

- ▲ All manufactured from Dupont® non-corrosive, UV stabilized "Zytel".
- ▲ Attach with flathead screws or rivets.
- ▲ Can be attached using 2 x G145/G147 eyelets.
- ▲ Available only in full packs of 100.

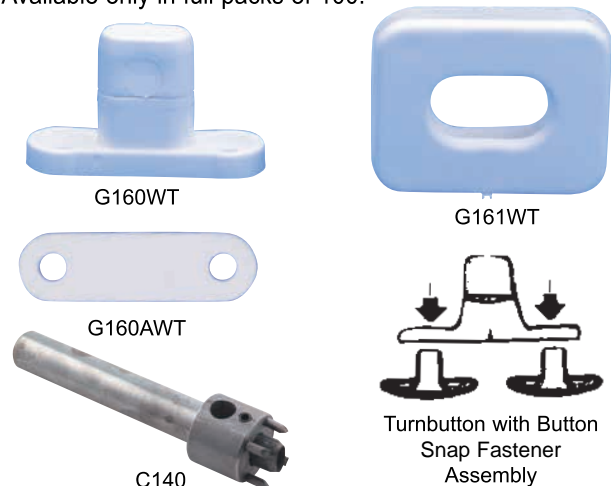

Part No.	Description	Color	Pack Qty
G160BK	Single Stud with 2 Screw Base	Black	100
G160WT	Single Stud with 2 Screw Base	White	100
G160ABK	Backplate for Stud	Black	100
G160AWT	Backplate for Stud	White	100
G161BK	Eyelet Clinch Lock (2 Part)	Black	100
G161WT	Eyelet Clinch Lock (2 Part)	White	100
C140	Eyelet Cutting Tool	-	1

## Loxx Fasteners

- ▲ Used on superior quality boats and cars.
- ▲ Positive locking action.
- ▲ Also previous known as Tenax brand.
- ▲ Made In Germany

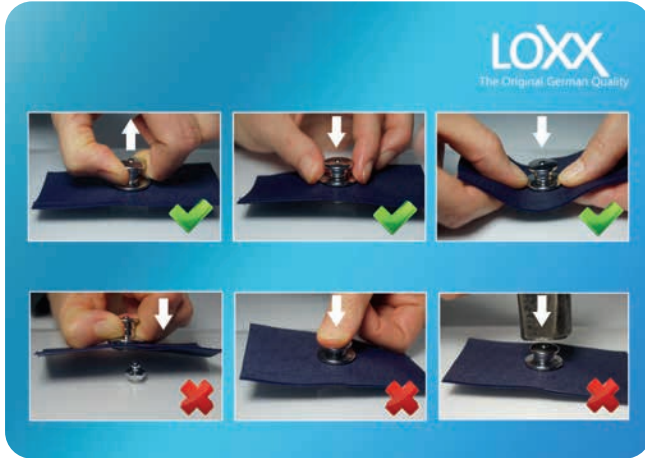

G165GCL



G165GCS



G164GC



G167GC



G165GTOOL

Part No.	Description	Pack Qty
G165GCL	Large Pull Top with Lock Washer	10
G165GCS	Small Pull Top with Lock Washer	10
G167GC	Wood Screw Stud 12mm	10
G165GTOOL	Basic Loxx Tool for Lock Washer	1
G164GC	M5 x 10mm Machine Screw	10

## Tenax Fasteners

- ▲ Used on superior quality boats and cars.
- ▲ Positive locking action.
- ▲ Made in England.

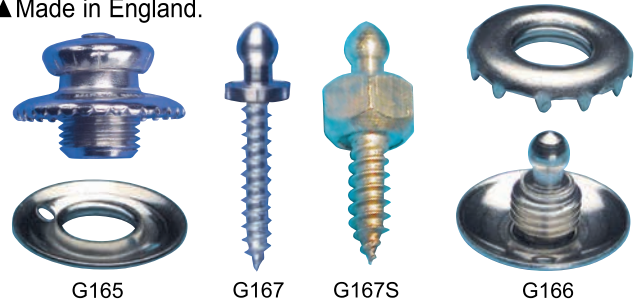

G165

G167

G167S

G166



G168

G164

G165TOOL

Part No.	Description	Manufacturers #	Pack Qty
G165	Standard Pull Top with Lock Washer	31/302	10
G166	Cloth Base Stud with Lock Washer	1/10	10
G167	Wood Screw Stud (1/8" x 1/2" thread)	11	10
G167S	Stud - Self Tapping SS Screw (5/32" x 1/2")	76	10
G168	2 Screw Stud	21	10
G165TOOL	Tool for Lock Washer	34	1
G164	#15 Machine Screw (5/32" x 1/2" thread)	15	10



## Eye Ends

- ▲ Die cast type 316 stainless steel.
- ▲ Mirror polished finish.
- ▲ G621SHD, G631SHD & G641SHD have 2 set screws and 5/16" pin hole in eye tab.
- ▲ Note: Standard style eye ends all have a 6.35mm/1/4" pin hole in the eye tab (except G642S - use with G640SHD).



Part No.	Description	Pack Qty
G611S	Eye End for 19mm/3/4" Tube	50
G621S	Eye End for 22mm/7/8" Tube	50
G631S	Eye End for 25mm/1" Tube	50
G642S	Eye End for 25mm/1" Tube with 5/16" pin hole	50
G621SHD	Heavy Duty Eye End for 22mm/7/8" Tube with 2 Set Screws	50
G631SHD	Heavy Duty Eye End for 25mm/1" Tube with 2 Set Screws	50
G641SHD	Heavy Duty Eye End for 32mm/1 1/4" Tube with 2 Set Screws	50

## Ball Swivel Jaw Slide and Eye Ends

- ▲ Increase frame versatility.
- ▲ Allows full movement range.
- ▲ Manufactured from 316 stainless steel.
- ▲ Double set screws.



Part No.	Description	Pack Qty
G730S	25mm/1" Ball Swivel Jaw	50

## Jaw Slides/Eye Ends

- ▲ Die cast type 316 stainless steel.
- ▲ Mirror polished finish.
- ▲ Note: G630SHD has 2 set screws and 1/4" pin hole.
- ▲ Note: G640SHD has 2 set screws and 5/16" pin hole.



Part No.	Description	Pack Qty
G610S	Jaw Slide for 19mm/3/4" Tube	50
G620S	Jaw Slide for 22mm/7/8" Tube	50
G630S	Jaw Slide for 25mm/1" Tube	50
G630SHD	H/Duty Jaw Slide for 25mm/1" Tube with 2 Set Screws	50
G640SHD	H/Duty Jaw Slide for 32mm/1 1/4" Tube with 2 Set Screws	50
G640SCR	5/16" Flat Head Spare Screw for G640SHD	5

## Double Jaw Slide with Swivel Hinge

- ▲ Manufactured from 316 stainless steel.
- ▲ Allows 2 eye ends to be connected to the same jaw.
- ▲ Accepts all sizes of eye end.
- ▲ Both ends take a 1/4" threaded screw



Part No.	Description	Pack Qty
G697S	25mm/1" Double Jaw with Swivel Hinge	50

## Split Hinged Jaw Slide For Q/R Pins

Mounts without the need to disassemble the rail. Ideal for use on rails that are welded together. Split jaw slide is permanently attached together to enable easier attachment to the rail in the exact position you desire.

- ▲ Package consists of one rail fitting and a stainless steel screw & nut.
- ▲ Type 316 stainless steel.
- ▲ Order G625PIN, G627PIN or G637PIN to connect eye ends with 1/4" pins.



Part No.	Description	Pack Qty
G820S	22mm/7/8" Outside Diameter	50
G830S	25mm/1" Outside Diameter	50
G840S	31mm/1 1/4" Outside Diameter	50

## Side Mount Jaw Slide

- ▲ Allows outboard or inboard mounts of Gemlock struts.
- ▲ Outboard mount allows Gemlock strut to act as grab rail.
- ▲ Grab rail stands off to allow bimini to fold flat.



Part No.	Description
G633S	22mm/7/8" Stainless Steel - Sliding
G635S	25mm/ 1" Stainless Steel - Sliding
G636S	32mm/1 1/4" Stainless Steel - Sliding

G655S	22mm/7/8" Stainless Steel - Separating
G656S	25mm/ 1" Stainless Steel - Separating
G657S	32mm/1 1/4" Stainless Steel - Separating

## Split Jawslide/Rail Fitting with Screw

Mounts without the need to disassemble the rail. Ideal for use on rails that are welded together. Split jaw slide is permanently attached together to enable easier attachment to the rail in the exact position you desire.

- ▲ Jaw Slide contains attaching screw and screw pin to secure eye end.
- ▲ Mirror polished Type 316 stainless steel.
- ▲ All sizes accept fitting with 1/4" pin hole.

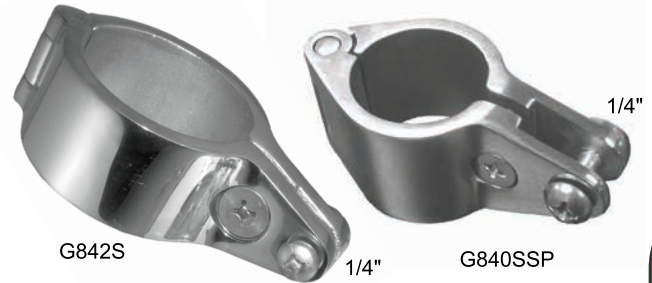

Part No.	Description	Pack Qty
G820SSP	Split Jaw Slide for 22mm/7/8" Outside Diameter tube	50
G830SSP	Split Jaw Slide for 25mm/1" Outside Diameter tube	50
G840SSP	Split Jaw Slide for 31mm/1 1/4" Outside Diameter tube	50
G842S	Split Jaw Slide for 50mm/2" Outside Diameter tube	10

## Black Nylon Boat Top Fittings

- ▲ High strength black nylon fittings.
- ▲ Excellent UV resistance
- ▲ Works with either stainless steel or aluminum tubing.



Part No.	Description	Pack Qty
G621BK	For Use with Tube Outside Diameter 22mm/7/8"	50
G620BK	For Use with Tube Outside Diameter 22mm/7/8"	50
G622BK	Flat Fitting with Screw Pin	50

## Universal Deck Hinges - All Stainless Steel

Universal deck hinge compensates for different angles of decks and coamings. Made from mirror polished stainless steel, even vertical surfaces can be accommodated.

- ▲ Die cast type 316 stainless steel.
- ▲ Mirror polished finish.
- ▲ Accepts all sizes of eye end.
- ▲ Compensates for different deck and coaming angles including vertical surfaces.



G615S

Part No.	Description	Pack Qty
G615S	Universal Deck Hinge with Screw	50

## Low Profile Deck Hinge

- ▲ Made in 316 stainless steel.
- ▲ Use G646S for larger angles.



G645S

G646S

G647A (\*Concave shoe only - deckmount fitting not included.)

Part No.	Description	Pack Qty
G645S	Angle Deck Hinge	50
G646S	Straight Universal Deck Hinge	50
G647A	*Concave Nylon Shoe Only	50

## Concave Hinges - Stainless Steel

- ▲ Manufactured from 316 stainless steel.
- ▲ G702S is 1" post mount, G704S is 1" fork mount.
- ▲ Concave base allows for rail/tube mounting.



G702S

G704S

Part No.	Description	Pack Qty
G702S	1" Post Mount	50
G704S	1" Fork Mount	50

## Ball Swivel with Quick Release Deck Mount

- ▲ Manufactured from 316 stainless steel.
- ▲ Greater range of motion.
- ▲ Base screws to the deck.
- ▲ Removing quick pin allows hinge to slide off the base.
- ▲ Double set screws.



G771S

G731S

Part No.	Description	Pack Qty
G771S	22mm/ 7/8 " Ball Swivel Deck Hinge	50
G731S	25mm/1" Ball Swivel Deck Hinge	50



## Deck Hinge Fittings - Screw Pin

- ▲ Die cast type 316 stainless steel.
- ▲ Mirror polished finish.



Part No.	Description	Pack Qty
G622S	Flat Hinge with Screw Pin	50
G623S	Angle Hinge with Screw Pin	50
G626S	Concave Hinge with Screw Pin	50

## Deck Hinge Fittings - Removable Pin

- ▲ Die cast type 316 stainless steel.
- ▲ Mirror polished finish.



Part No.	Description	Pack Qty
G625S	Flat Hinge with Removable Drop Nose Pin	50
G625SQP	Flat Hinge with Quick Release Pin	50
G628S	Angle Hinge with Removable Drop Nose Pin	50
G628SQP	Angle Hinge with Quick Release Pin	50
G651S	Concave Hinge with Removable Drop Nose Pin	50



## Side Mount Fitting

- ▲ Die cast type 316 stainless steel.
- ▲ Mirror polished finish.
- ▲ Accepts all sizes of eye end.



Part No.	Description	Pack Qty
G624S	4 Hole Side Mount 8.0mm/ 5/16 " Bolt	50
G632S	4 Hole Side Mount 6.4mm/ 1/4 " Bolt	50
G629S	2 Hole Side Mount 6.4mm/ 1/4 " Bolt	50

## Lanyard

- ▲ Lanyard is used to attach quick release pin to the deck hinge to prevent accidental loss.

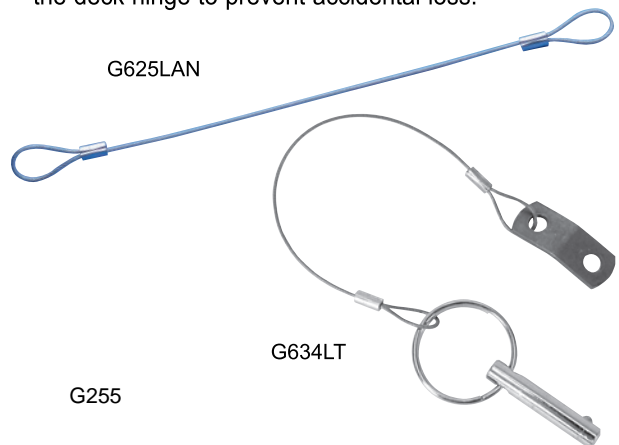

Part No.	Description	Pack Qty
G625LAN	Stainless Steel Wire - 152mm/6"	50
G634LT	6.4mm/ 1/4" I.D. Pin, 152mm/6" S.S. Wire with Tab	50
G255	3/16" SS Aft Pin Welded Ring	50

## Removable Pins

- ▲ Die cast type 316 stainless steel.
- ▲ Mirror polished finish.



Part No.	Description	Pack Qty
G627PIN	Drop Nose Pin 6.4mm/ 1/4 " O.D.	50
G625PIN	Quick Release Pin 6.4mm/ 1/4 " O.D. with S.S. Ring	50
G637PIN	Drop Nose Pin 6.4mm/ 1/4 " O.D. with S.S. Ring	50
G681PIN	Pin W/Lanyard For Ball Deck Hinge	50
G255	3/16" SS Aft Pin Welded Ring	50

## Frame Tube Hinge with Quick Release Locking Pin

- ▲ Heavy duty design and construction.
- ▲ Allows frame or strut to fold.
- ▲ Quick release locking pin, locks only when straight.
- ▲ Manufactured from 316 stainless steel.



Part No.	Description	Tube Size: mm/inch	
G744S	Heavy Duty Stainless Steel Tube Hinge	25	1
G747S	Heavy Duty Stainless Steel Tube Hinge	22	7/8

## Stainless Steel Spring Ball

- ▲ All stainless steel designed for tubing 19mm/3/4 inch to 32mm/1 1/4 inch inside diameter.

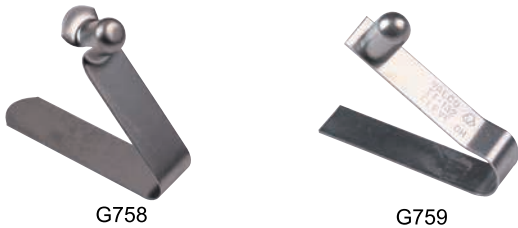

Part No.	Description	Pack Qty
G758	Stainless Steel Snap - Spring Ball - Hollow Head	100
G759	Stainless Steel Snap - Spring Ball - .250 Insert	100

## Stainless Steel Set Screws

- ▲ Spare stainless steel set screws for eye ends or jawslides.
- ▲ Available only in full packs of 5 or 10.



Part No.	Description	Qty Per Pack
G620SS	6.4mm/ 1/4 " - 20 Stainless Steel Set Screws	10
G623SS	Spare Screw for G622S, G623S, G626S, G615S etc.	10
G640SCR	5/16" Flat Head Spare Screw for G640SHD	5

## Ball & Socket Fittings

Ball and socket design offers quick and easy fold and removal of bimini tops. A variety of tube, deck and side mounting options are available.

- ▲ Full rotation of top frame.
- ▲ Delrin inserts insure smooth movement and a rattle free fit.
- ▲ Pin lanyard system for secure positioning and quick release.
- ▲ Polished 316 stainless steel.



G672S  
G682S



G678S



G675S



G671S  
G681S



G677S

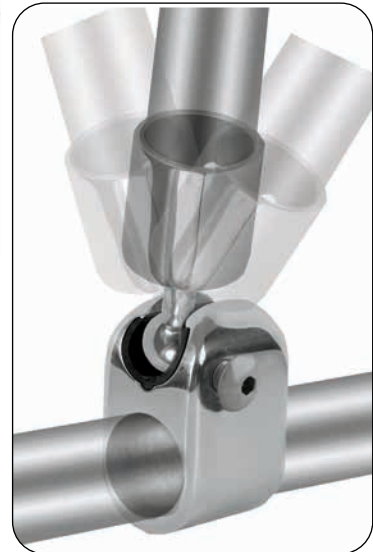

G674S

Part No.	Description
G671S	22mm/ 7/8 " Stainless Steel Ball Eye End
G681S	25mm/1" Stainless Steel Ball Eye End
G678S	22mm/ 7/8 " Stainless Steel 90 Degree Ball Eye End
G672S	22mm/ 7/8 " Stainless Steel Socket Jaw Slide
G682S	25mm/1" Stainless Steel Socket Jaw Slide
G675S	Stainless Steel Socket Deck Hinge with Pull Pin & Lanyard
G674S	Stainless Steel Concave Deck Hinge with Pull Pin & Lanyard
G677S	Stainless Steel Socket Deck Hinge with External Screw Mount
G687S	22mm/ 7/8 " Stainless Steel Swivel Double Jaw Slide
G681PIN	Pin W/Lanyard For Ball Deck Hinge

## HD Folding Deck Hinge

- ▲ Hinge system compensates for different angles of deck and coamings without the need for wedges.
- ▲ Folds flat when the canopy is removed preventing snagging and injury.
- ▲ Manufactured from type 316 stainless steel.
- ▲ Use with G611S, G621S, G631S and G641S.



Part No.	Description	Pack Qty
G607S	Stainless Steel HD Folding Deck Hinge	50

## Universal Flat Deck Hinge

- ▲ Manufactured from 316 stainless steel.
- ▲ Deck hinge swivels 180°.

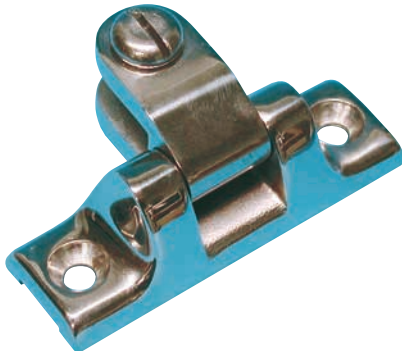

Part No.	Description	Pack Qty
G692S	Flat Universal Deck Hinge	50

## Quick Release Deck Mount - Black Nylon

- ▲ Manufactured from black nylon & stainless steel.
- ▲ Use with G611S, G621S, G631S and G641S.



Part No.	Description	Pack Qty
G605BK	Quick Release Deck Mount - Black Nylon	1

## Quick Release Deck Mount

- ▲ Spring-loaded release button ejects eye end for almost instant frame removal.
- ▲ Stylish and unique design.
- ▲ Manufactured from type 316 stainless steel.
- ▲ Use with G611S, G621S, G631S and G641S.



G605SHNT



G605SHBK

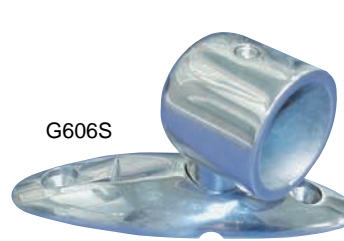

G606S



Part No.	Description	Pack Qty
G605S	Quick Release Deck Mount	24
G606S	22mm/ 7/8 " Quick Release Side Mount	50
G608S	25mm/1" Quick Release Side Mount	50
G605SHNT	Shim - Natural	50
G605SHBK	Shim - Black	50
G609S	Quick Release Loop 1" Stainless Steel	50

## Heavy Duty Quick Release Deck Mount

- ▲ Heavy duty design & construction.
- ▲ Allows full 360 degree rotation.
- ▲ Three position lock.
- ▲ Accepts extra wide tab eye ends.
- ▲ Secure three point mounting.



G604S

Part No.	Finish	Pack Qty
G604S	316 Stainless Steel	1

## Universal Boat Top Frame Kits

- ▲ Ready to assemble kit form.
- ▲ Easy to use, fits boats to 2.4m/96 inches wide.
- ▲ Manufactured from marine grade aluminum tube and die cast hardware.
- ▲ No bending tools required.
- ▲ Can ship UPS.

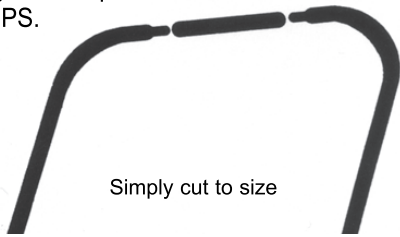

▲ Packaged 1 boat set per box with hardware. Boxes can be shipped by UPS. Made with 22mm/ 7/8 inch O.D. x 0.058" wall, 6063 T832 hard drawn marine aluminum tubing with a brite anodized finish and joined together with inside sleeves. The radius of the bends are 152mm/6 inch I.D.

## Extra Large 2 Bow Frame Kit

- ▲ Kit contains:  
4 x die cast eye ends.  
2 x die cast jaw slides.  
2 x die cast hinges.  
2 x bow assembly pre-formed 22mm/ 7/8 inch aluminum tubing.

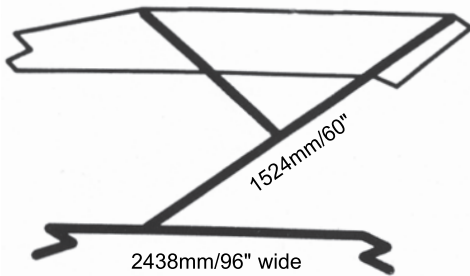

Part No.	Description
G522A	2 Bow Aluminum Frame Kit

## Bimini 3 Bow Frame Kit

- ▲ Kit contains:  
6 x die cast eye ends.  
4 x die cast jaw slides.  
2 x die cast hinges.

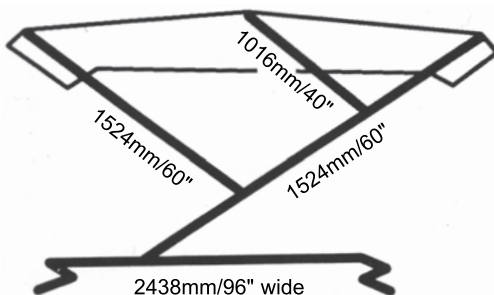

Part No.	Description
G523A	3 Bow Aluminum Frame Kit

## Heavy Duty Canopy Track System

- ▲ Top quality way to solve the problem of improving canopy or enclosure.
- ▲ This unique system is easily fitted and adds extra functionality to most modern styles of canopy or enclosure.
- ▲ 25mm/1 inch H.D. track system.
- ▲ Stainless steel fittings pre-assembled to car.



Part No.	Description	Pack Qty
G710	Car Includes S.S. Universal Deck Hinge	Each
G712	1.2m/48" Aluminum Track	Each
G718	1.8m/71" Aluminum Track	Each
G713	Track End Stops - Sold in Pairs	Pair

## Duo Track System

- ▲ Quick release adjustment.
- ▲ Manufactured from 316 stainless steel.
- ▲ Ultra low profile design with positive locking mechanism.
- ▲ Easily operated by hand or foot.
- ▲ Ideal for mounting biminis on center cockpits.

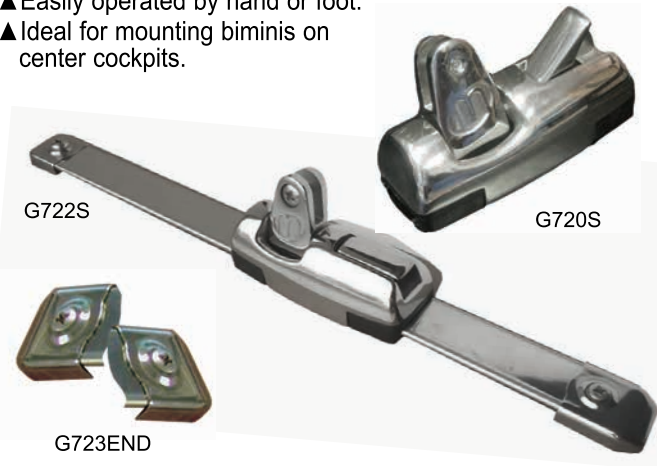

Part No.	Tube (External): mm/in	Pack Qty
G722S	Duo Track - 1.8 Meters Long	Each
G723END	Duo Track Stainless Steel End Stop	Each
G720S	Sleek Duo Track Car	Each
G719SLEFT	Sleek Duo Track Car - Left	Each
G719SRIGHT	Sleek Duo Tack car - Right	Each

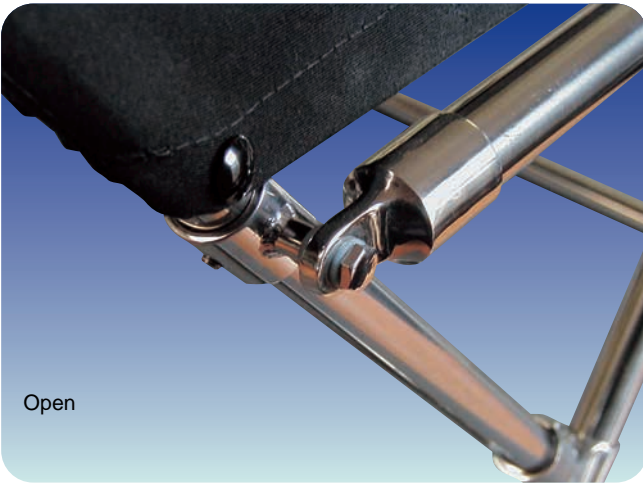

Open



Closed

## Gemlock Pre-Made Strut with Hinge

- ▲ Completely assembled struts with stainless steel hinges, either 22mm/ 7/8 inch or 25mm/1 inch tubing, locking sleeve and spring balls.
- ▲ Uses: folding dodger frames (DropTop™ style), spreader bars on biminis (strapless biminis), stowable dinettes and chart tables, cantilever supports for swim platforms and drop seats, support struts for davits and towers.

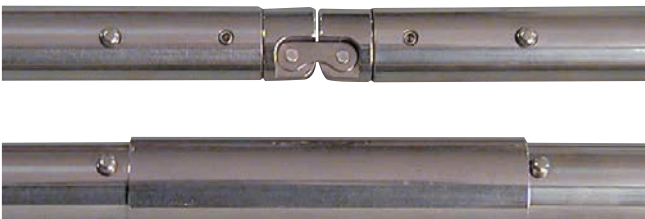

Part No.	Description	Tube Size: mm/in	Length: mm/in
G750SSET/3	Adjustable Strut	22 7/8	900 36
G751SSET/3	Adjustable Strut	25 1	900 36
G751SSET/6	Adjustable Strut	25 1	1800 72



**Caution!**

Warning: Each set comprises one complete strut - two struts are required to make a folding top.

## Gemlock Collapsible Hinge

- ▲ The Gemini™ hinge (patent pending) and strut assembly provides a simple way to build collapsible supports and folding frames with no disassembly of frame parts. To fold the strut, slide the locking sleeve and pop the hinge.
- ▲ Can be fitted to existing frames.
- ▲ Unique hinge design allows strut to fold completely flat.
- ▲ External sleeve locks joint and provides full working strength to the strut, protecting the hinge from loads.
- ▲ Spring ball lock sleeve in place stops accidental folding.
- ▲ A complete installation for each side will require 1 hinge, 1 locking sleeve, 2 snap buttons and 2 set screws.
- ▲ Full installation instructions sheet available upon request.
- ▲ Use for folding: spray hoods, biminis and tables.

## Gemlock Hinge & Sleeve



Part No.	Description	Tube Diameter: mm/in	Wall Thickness: mm/in
G750S	S.S. Gemini Hinge	22 7/8	1.6 0.065
G751S	S.S. Gemini Hinge	25 1	1.6 0.065
G760	S.S. Locking Sleeve	22 7/8	1.6 0.065
G761	S.S. Locking Sleeve	25 1	1.6 0.065
G761/10	S.S. Locking Sleeve	25 1	1.6 0.065

## Gemini Sliding Side Mount

- ▲ Allows outboard or inboard mounts of Gemlock struts.
- ▲ Outboard mount allows the Gemlock strut to act as grab rail.
- ▲ Grab rail stands off to allow bimini to fold flat.



Part No.	Description
G633S	22mm/ 7/8 " Stainless Steel
G635S	25mm/ 1" Stainless Steel
G636S	32mm/1 1/4" Stainless Steel
G655S	22mm/ 7/8 " Stainless Steel - Separating
G656S	25mm/ 1" Stainless Steel - Separating
G657S	32mm/1 1/4" Stainless Steel - Separating

## Bendarc Tube Bender

- ▲ Bendarc Quick-Switch - Gives strong bends with smooth, rounded corners.
- ▲ Designed for wall or bench mounting and easy pull down use, Bendarc can bend 152mm/6 inch radius to 300mm/12 inch radius, depending on which dies are purchased.
- ▲ Easy, pull-down use. Wall mounting allows your body weight to help.
- ▲ Quick and easy to switch sizes.
- ▲ Constructed of boiler plate steel with bearing supported roller and powerful 998kg/2200 lb. clamp.
- ▲ Rollers are high density polymer for mar resistant contact with fine tubing finishes.

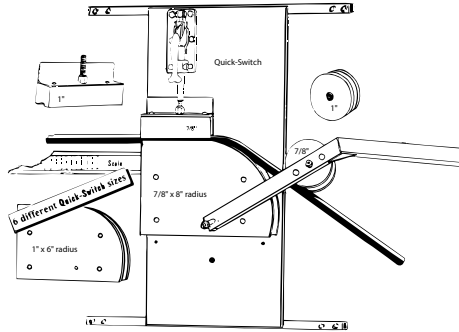

Part No.	Standard Bendarc With Dies To:
C997	Bend 25mm/1" Tube to 203mm/8" Radius Bend 25mm/1" Tube to 250mm/10" Radius
C995B	Bend 32mm/1 1/4" Tube to 250mm/10" Radius

Custom order to your specification.  
Order one or several die sizes.



## Crownarc Tube Bender

- ▲ Crownarc - The only crowner with gear drive.
- ▲ Mounted on the wall, a table or on the side or rear of a truck, Crownarc puts a crown onto tubing.
- ▲ Bends 19, 22 & 25mm/ 3/4, 7/8 & 1 inch outside diameter tubing using the same dies.
- ▲ Dies and rollers are mounted on a backplate of boiler plate steel.
- ▲ Rollers are high density polymer.
- ▲ The center roller is fully adjustable.

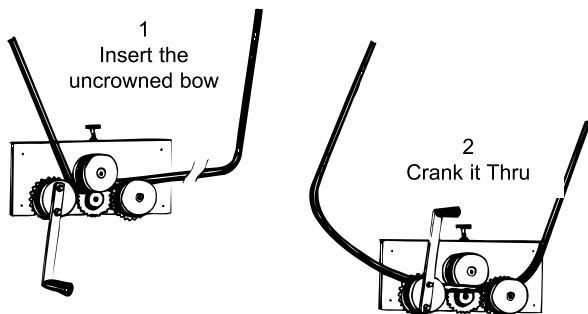

Part No.	Bends Tube Size
C998	19, 22 & 25mm/ 3/4, 7/8 & 1" Tubing
C998/114	1 1/4" Tubing

## Adjustable Eye Ends

- ▲ Designed to tighten canvas on bimini tops.
- ▲ A pair can adjust 2 inches in length.
- ▲ One pair = one right and one left thread.
- ▲ Requires one pair per strut - 2 pairs to make a set.

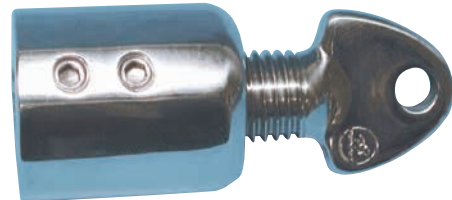

Part No.	Description	Pack Qty
G846S	25mm/1" Tube Adjuster	Pair

NOTE: 2 pairs of G846S are needed to make a set.



## Canvas Clip

- ▲ Helps to hold fabric on frame while patterning.
- ▲ One end can be used on 7/8", the other is for 1".



Part No.	Description	Pack Qty
G380	Canvas Clip	50

## Stainless Steel Tubing

- ▲ Tubing is sold in 7.3m/24 foot lengths only, and must ship by common carrier.
- ▲ Type 304.

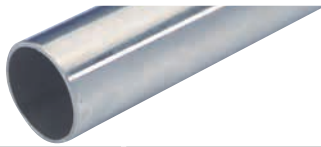

Part No.	Outside Tube Diameter: mm/in		Wall Thickness: mm/in	
G503S	22	7/8	1.7	0.065
G505S	25	1	1.7	0.065
G504S	32	1 1/4	1.7	0.065

## Aluminum Tubing

- ▲ Tubing is sold in 6.1m/20 foot lengths only, and must ship by common carrier.

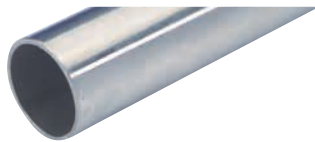

Part No.	Outside Tube Diameter: mm/in		Wall Thickness: mm/in	
G300A	22	7/8	1.2	0.058

## Drill Steady

Designed to clamp onto frames or tubing without disassembling frame.

- ▲ Swing over design.
- ▲ Bronze cast body.
- ▲ Requires 5/64" cobalt drill bit to set No.8 screws.



Part No.	Description
C899	Drill Steady

## Sunblocker Clip

Sunblocker is a self insulated protective clip which eliminates contact between your metal tubular top frame and the clear plastic windows.

Two or three Sunblocker clips on metal frame tubing can give maximum protection against destruction of clear plastic windows, by reducing singeing, scorching and heat cracking.

- ▲ Marine gray color.

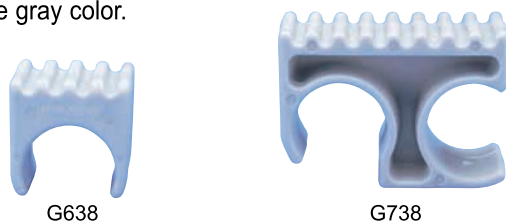

Part No.	Description	Pack Qty
G638	Single For Use with Tube Outside Diameter 22mm/ 7/8"	50
G639	Single For Use with Tube Outside Diameter 25.4mm/1"	50
G738	Twin For Use with Tube Outside Diameter 22mm/ 7/8"	50

## Stainless Steel Grab Rail w/Studs

- ▲ Manufactured from 316 stainless steel.
- ▲ Heavy duty polished construction.
- ▲ Stainless steel bolt with 1/4" – 20 threads x 1 3/4" long.



Part No.	Description	Pack Qty
G380/18	18" (457mm) Stainless Steel Grab Rail	10
G380/24	24" (610mm) Stainless Steel Grab Rail	10
G848S	Split Hand Rail End	10

## SUN SOX To Protect Plastic Windows

Windows resting against hot tube framing can be scorched, turn colors and be destroyed. New SUN Sox offer a simple and inexpensive protection.

Made from a non-woven poly blend of fibers with a velcro strip on one edge, SUN SOX simply wraps around tubing and secures to itself.

- ▲ 6" x 72" lengths can be cut to match tube size and come in six attractive colors.
- ▲ Simple do it yourself installation offers easy on easy off or leave year round.
- ▲ Fits 1 1/4" Tubing.

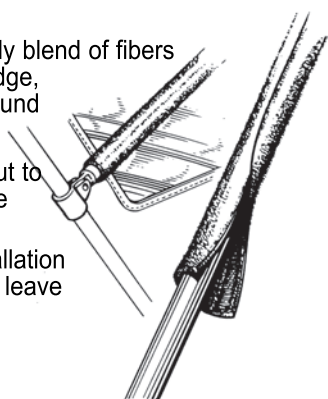

Part No.	Color	Length m/ft	
LS401GY	Gray	1.8	6
LS401BU	Blue	1.8	6
LS401BK	Black	1.8	6
LS401TN	Beige	1.8	6
LS401BG	Burgundy	1.8	6

## J-Hook

- ▲ Stainless steel hook to fit over 1 1/8" (29mm) gunwale.
- ▲ Requires no fitting on deck.
- ▲ 3/4" (19mm) wide x 2 1/2" (64mm) long.

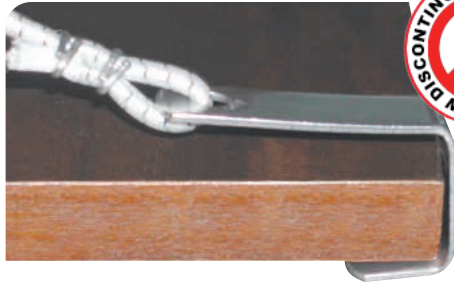

Part No.	Description
G858S	Stainless Steel J-Hook

## Plastic J-Hook

- ▲ Black plastic hook to fit over 1 1/8" (29mm) gunwale.
- ▲ Requires no fitting on deck.
- ▲ Sold each or in packs of 25 pieces.



Part No.	Description	Pack Quantity
A090BK	Black Plastic J-Hook	25

## Inflatable Boat Hook

- ▲ Rigid plastic boat hook.
- ▲ Manufactured from white nylon.
- ▲ Accepts 1/8" to 1/4" shock cord.



P44015

Part No.	Description	Pack Quantity
P44015	White Nylon Rigid Boat Hook	10



## Fender Hook

- ▲ Stainless Steel
- ▲ Sold each or full 100 per pack.



Part No.	Finish	Pack Qty
G225S	Fender Hook	100



## Speedy Rivets

- ▲ Use with B401 Hooks.
- ▲ Tap the two parts together with a hammer until they connect firmly.
- ▲ Only order by full pack - 100 per pack.



Part No.	Finish	Pack Qty
D050N	Nickel Plated Brass	100

## Screws – Stainless Steel

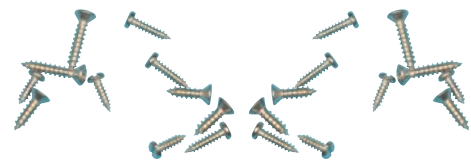

Part No.	Size: mm/in	Style	Head
D350	No. 4 x 3/8 (10)	Self Tapping	Pan
D351	No. 4 x 1/2 (12)	Self Tapping	Pan
D353	No. 6 x 1/2 (12)	Self Tapping	Pan
D355	No. 6 x 1/2 (12)	Self Tapping	Flat
D352	No. 6 x 3/8 (10)	Self Tapping	Pan
D372	No. 6 x 3/4 (19)	Self Tapping	Flat
D373	No. 6 x 3/4 (19)	Self Tapping	Oval



## Sew-on Cover Hooks & Eyelets - Plastic

- ▲ Injection moulded in nylon.
- ▲ Sew through plastic with straight stitch sewing machine.
- ▲ Can be used alone or together.



A068WT



A069WT

Part No.	Description	Color	Pack Qty
A069BK	Hook	Black	100
A069WT	Hook	White	100
A068BK	Eyelet	Black	100
A068WT	Eyelet	White	100

## Wire Cover Hooks

Ideal method for a simple lacing line run between grommets and cover hook.

- ▲ Hand sew or use D050N speedy rivets with washers.
- ▲ Suitable for up to 9.5mm/ 3/8 inch shock cord.
- ▲ Use SS washers as back plates.



B401S

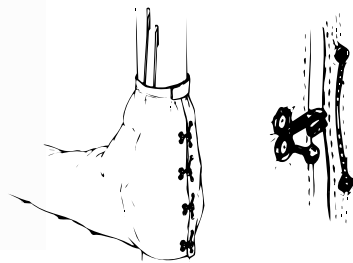

Part No.	Description	Material	Pack Qty
B401S	Hook	Stainless Steel	100

## Rivet-on Cover Hook - Plastic

- ▲ Injection moulded in nylon.
- ▲ Use D337 rivets or D383 rivets.
- ▲ Suitable for max 6.4mm/ 1/4 inch shockcord.



Part No.	Color	Pack Qty
A071	White	100

## Shock Cord Cover Clip

- ▲ Used with a lacing knob or other cord cover clip for a fast and simple tie-down.
- ▲ Does not require tool to set.
- ▲ Now easier attaching system.



Part No.	Overall Length: mm/in	Color	Pack Qty
G040BK	86 3 3/8	Black	50
G040WT	86 3 3/8	White	50

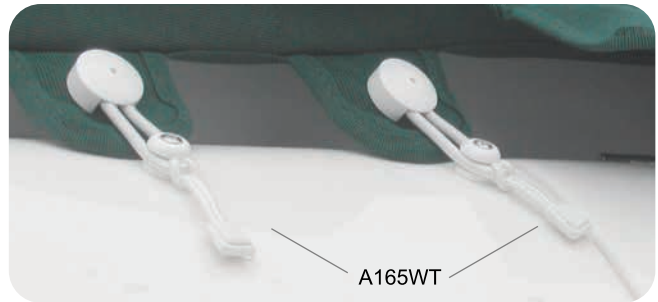

### Page Navigation

Zipper Pulls  
Please see page 102 for  
A165BK/WT Zipper Pulls.



## Shock Cord Lacing Knob

Used with a cord cover clip for a fast and simple tie-down.  
▲ Attaches with a screw.



Part No.	Use with Cord Diameter: mm/in	Knob Diameter: mm/in	Color	Pack Qty
G045BK	5 3/16	18 11/16	Black	100
G045WT	5 3/16	18 11/16	White	100



### Adjustable Support Pole with Cam Action

- ▲ Comes with three interchangeable tips.
- ▲ No. 1 – pole end fits No. 3 spur grommet.
- ▲ No. 2 – soft vinyl tip similar to the foot.
- ▲ No. 3 – with button snap accepts standard G142 socket.
- ▲ Aluminium support pole adjusts from 1m/40" to 1.7m/70".



Part No.	Description
G371	Support Pole with Cam Action - Adjusts from 1.0 to 1.7 meters (40" to 70")

### Boat Vent 3

- ▲ Larger opening than previously for 40%+ greater airflow.
- ▲ UV resistant material.
- ▲ Fast installation.- No screws or awls needed.
- ▲ Fits 3/4" or 7/8" tubing.
- ▲ Attach to the top of adjustable mooring pole (Please Note: G371 - IS NOT INCLUDED).
- ▲ Use for venting the area below the cover.



G050BK



G048BK

Part No.	Description
G048BK	Boat Vent 3 - Boat Cover Vent NEW
G050BK	Boat Ven 2 - Boat Cover Vent

### Rubber Mooring Pole Base

- ▲ Rubber pad to protect and hold the pole in position without sliding.
- ▲ Can be locked into the best position for the boat.



Part No.	Description
G049BK	Rubber Mooring Pole Base



### Boat Cover Socket

- ▲ Use one or more pairs of sockets with 45NT fiberglass batten material to support boat cover.
- ▲ Use No 8 flat or oval head screws.
- ▲ Sockets are sold in pairs only.



Part No.	Description	Pack Qty
G670	Chrome Die Cast	10 pair

### Fiberglass Bow Slat

- ▲ Use with boat cover sockets (G670, above) forming an arch to support boat cover.
- ▲ Bow Slat/Battens are supplied in 7.6m/25 ft lengths only.



Bow slat end profile

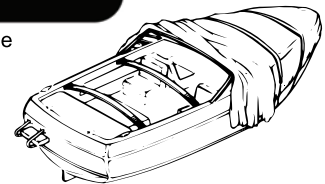

Part No.	Batten Width: mm/in	Batten Thickness: mm/in
45NT	45 1 3/4	6 1/4

### Adjustable Anodized Aluminum Awning Poles



Part No.	Description
G308	Adjusts from 4 to 8 feet (1.2 to 2.4 meters)
G309	Adjusts from 6 to 12 feet (1.8 to 3.6 meters) - Heavy Duty

### Pattern 2-X Pattern Material

- ▲ High quality semi-opaque product offering the best way to pattern a wide variety of projects.
- ▲ Manufactured from high quality polyethylene filaments coated on both sides to provide excellent tear strength & directional stability.



Part No.	Description	Thickness: mm/in		Roll Length: m/yd	
FP085-72	1380mm/72 inch Wide	0.12	0.005	91	100
FP087-144	3660mm/144 inch Wide	0.12	0.005	45.5	50

### Measuring Tapes - Metal

- ▲ Impact resistant ABS case with winding handle.
- ▲ Double sided 10mm blade: meters x cm/mm. reverse side: feet x inches/ 1/8 inches.



Part No.	Description
C705	30m/100ft Steel Tape

### Measuring Tapes - Fiberglass

- ▲ Impact resistant case.
- ▲ C713 - Graduated top edge: feet x inches/1/8 inches bottom edge: meters x centimeters/millimeters.
- ▲ C706 - Graduated top edge: feet x inches/1/10 inches bottom edge: meters x centimeters/millimeters.



Part No.	Description	Scale
C713	30m/100ft/ Fiberglass	ft-in/m-mm
C706	30m/100ft/ Fiberglass	ft/1/10 ft



Caution!

- ▲ Note: Always check the position of point zero before use.

### Pony Cloth Clamps



Part No.	Jaw Opening: mm/in		Overall Length: mm/in	
C515	25	1	102	4
C516	51	2	152	6
C517	76	3	229	9

### Washable Marking Pencils

Ideal for making marks on Sunbrella, Top Gun or most other fabrics and vinyls.

- ▲ Use a moist sponge or damp fabric towel to remove pencil marks.
- ▲ Pencils do not contain wax.

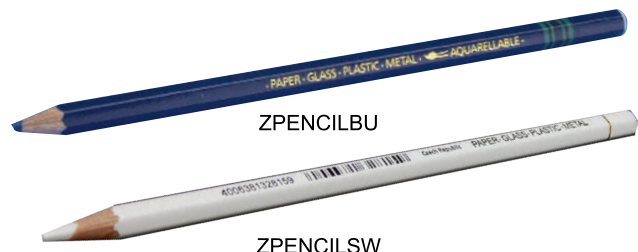

Part No.	Color	Pencils Per Box
ZPENCILSW	White	Each or 144
ZPENCILBU	Blue	Each or 144

### China Marker

Marks on boat top, industrial vinyls, glass, window vinyl, polycarbonate or any polished surface.

- ▲ String-pull sharpening.
- ▲ Wipes off easily with a damp cloth.



Part No.	Color	Pencils Per Box
ZMARKERWT	White	12



Caution!

- ▲ Note: Always test effectiveness of china markers and washable pencils on a scrap piece of the exact material before use on a new project.

## Flat Battens

Non-tapered pultruded fiberglass stock is sold by the foot for use in production sails where an economical batten is required. The larger sizes are also suitable for use in full batten mainsails.

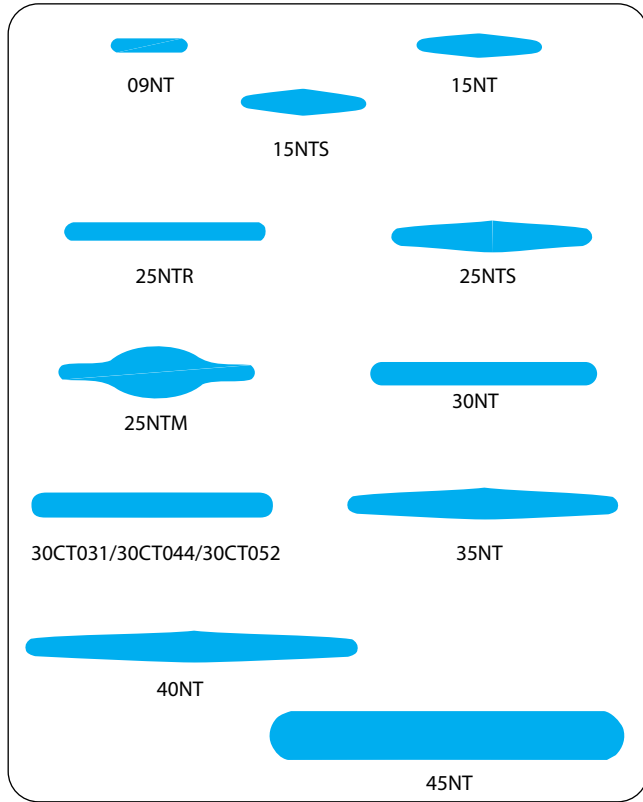

Pt No.	Width: mm/in	Thickness: mm/in	Stiffness	Weight: gm/m/oz ft	Length: m/ft
09NT	10mm 3/8"	2.4mm 0.98"	100	37.2gsm 0.4oz ft	4m 13ft
15NT	16mm 5/8"	3mm 0.118"	350	73gsm 0.9oz ft	4.6m 15ft
15NTS	16mm 5/8"	3.1mm 0.120"	450	76gsm 0.9oz ft	3.7m 12ft
25NTR	25mm 1"	2.4mm 0.098"	650	112gsm 1.2oz ft	4m 13ft
25NTS	25mm 1"	3.9mm 0.157"	1,100	130gsm 1.4oz ft	7.6m 25ft
25NTM	25mm 1"	7.7mm 0.304"	5,000	186gsm 2.0oz ft	7.6m 25ft
30NT	30mm 1 3/16"	3mm 0.118"	1,000	158gsm 1.7oz ft	4m 13ft
30CT031	30mm 1 1/4"	3.1mm 1/8"	1000	188gm/m 2.0oz/ft	6m 20ft
30CT044	30mm 1 3/16"	4.4mm 0.156"	3,000	266gsm 2.9oz ft	6m 20ft
30CT052	30mm 1 3/16"	5.2mm 0.218"	5,000	315gsm 3.4oz ft	6m 20ft
35NT	33mm 1 3/16"	3.9mm 0.157"	1,200	177gsm 1.9oz ft	6.1m 20ft
40NT	41mm 1 5/8"	3.9mm 0.157"	3,000	288gsm 3.1oz ft	6.1m 20ft
45NT	44mm 1 3/4"	6.4mm 0.250"	18,000	549gsm 5.9oz ft	7.6m 25ft

For more information on our full range of sailcloth & sailmaking hardware, please refer to our Sailcloth/Hardware Catalog



## Sailman™ Battens

Highest quality vinylester pultrusions deliver ultimate strength and durability for demanding full batten applications. Selected for the BT Global Challenge, a race around the world the hard way, they feature a logical and progressive range of stiffnesses, and a common 30mm width.

- Purpose designed range for Bainbridge International's range of full batten systems.
- Highest quality vinylester pultruded glassfiber.
- Ultimate tenacity for full batten sails in an offshore application.
- Race proven in the BT Global Challenge.
- Offer round batten stiffness without the problems of chafe and 'batten snake'.

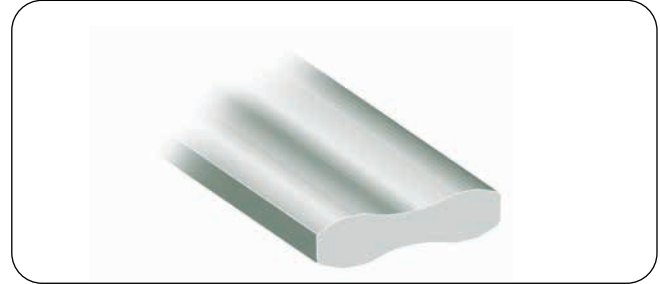

Pt No.	Width: mm/in	Thickness: mm/in	Stiffness	Weight: gm/m/oz ft	Length: m/ft
U30063	30mm 1.18"	6.3mm 0.25"	7,000gm	293gsm 3.2oz ft	12m 39.4ft
U30076	30mm 1.18"	7.6mm 0.31"	15,000gm	382gsm 4.1oz ft	12m 39.4ft
U30102	30mm 1.18"	10.2mm 0.40"	37,000gm	530gsm 5.7oz ft	12m 39.4ft
U30114	30mm 1.18"	11.4mm 0.44"	58,000gm	618gsm 6.6oz ft	12m 39.4ft

## Round Battens

Outstanding stiffness to weight combined with low cost make round section pultrusions an excellent choice for full batten applications, although they are more susceptible to breakage and can cause sail chafe.

- Considerably better stiffness/weight ratio than flat battens.



Pt No.	Width: mm/in	Stiffness gm/m/oz ft	Deflection m/ft	Weight:	Length:
06RD	6mm 1/4"	1,000 0.56oz ft	20ft	52gsm	6.1m
08RD	8mm 5/16"	3,500 0.95oz ft	20ft	88gsm	6.1m
10RD	10mm 3/8"	9,000 1.55oz ft	58 20ft	144gsm	6.1m
11RD	11mm 7/16"	17,000 2.27oz ft	29 20ft	211gsm	6.1m
15RD	16mm 5/8"	60,000 3.07oz ft	9 25ft	286gsm	7.6m
20RD	19mm 3/4"	6,030z ft	5 25ft	560gsm	7.6m

### Polyester Sailcloth Tape

- ▲ Other weights/widths can be supplied. Please inquire.
- ▲ All rolls are 70-110 yard nominal.
- ▲ Available only on full rolls.
- ▲ Can be supplied folded against special order.



Part No.	Weight: sm oz	Width: mm/in
F35/075	3.9 US sm oz Polyester	19.0 3/4
F35/100	3.9 US sm oz Polyester	25.0 1
F35/150	3.9 US sm oz Polyester	38.0 1 1/2
F35/200	3.9 US sm oz Polyester	50.0 2
F35/250	3.9 US sm oz Polyester	63.5 2 1/2
F35/300	3.9 US sm oz Polyester	76.0 3
F35/400	3.9 US sm oz Polyester	102.0 4
F50/150	5.0 US sm oz Polyester	38.0 1 1/2
F50/200	5.0 US sm oz Polyester	50.0 2
F50/250	5.0 US sm oz Polyester	63.5 2 1/2
F50/300	5.0 US sm oz Polyester	76.0 3
F50/350	5.0 US sm oz Polyester	89.0 3 1/2
F50/400	5.0 US sm oz Polyester	102.0 4
F50/500	5.0 US sm oz Polyester	127.0 5
F60/100	6.0 US sm oz Polyester	25.0 1
F60/150	6.0 US sm oz Polyester	38.0 1 1/2
F60/200	6.0 US sm oz Polyester	50.0 2
F60/250	6.0 US sm oz Polyester	63.5 2 1/2
F60/300	6.0 US sm oz Polyester	76.0 3
F60/350	6.0 US sm oz Polyester	89.0 3 1/2
F60/400	6.0 US sm oz Polyester	102.0 4
F60/500	6.0 US sm oz Polyester	127.0 5
F70/250	7.0 US sm oz Polyester	63.5 2 1/2
F70/300	7.0 US sm oz Polyester	76.0 3
F70/350	7.0 US sm oz Polyester	89.0 3 1/2
F70/400	7.0 US sm oz Polyester	102.0 4
F70/500	7.0 US sm oz Polyester	127.0 5
F70/600	7.0 US sm oz Polyester	152.0 6
F80/300	8.0 US sm oz Polyester	76.0 3
F80/400	8.0 US sm oz Polyester	102.0 4
F80/500	8.0 US sm oz Polyester	127.0 5
F90/300	9.0 US sm oz Polyester	76.0 3
F90/400	9.0 US sm oz Polyester	102.0 4
F90/500	9.0 US sm oz Polyester	127.0 5
F90/600	9.0 US sm oz Polyester	152.0 6

#### Custom Slitting

- ▲ Saves time.
- ▲ Almost any fabric can be slit.
- ▲ Your choice of widths.
- ▲ Hot or Cold slit.
- ▲ Hot slit is used to seal edges.
- ▲ Slitting done in Canton, MA.



### Polyester Colored Sailcloth Tape

- ▲ These tapes are manufactured from 167gsm/3.9sm oz polyester sailcloth.
- ▲ All rolls are 70-100 yards nominal.
- ▲ Available only on full rolls.



Part No.	Weight: smoz	Color	Width: mm/in
F35/100RD	3.9 US sm oz Polyester	Red	25 1
F35/100GR	3.9 US sm oz Polyester	Green	25 1
F35/100BU	3.9 US sm oz Polyester	Blue	25 1
F35/100BK	3.9 US sm oz Polyester	Black	25 1
F35/150RD	3.9 US sm oz Polyester	Red	38 1 1/2
F35/150GR	3.9 US sm oz Polyester	Green	38 1 1/2
F35/150BU	3.9 US sm oz Polyester	Blue	38 1 1/2
F35/150BK	3.9 US sm oz Polyester	Black	38 1 1/2
F35/200RD	3.9 US sm oz Polyester	Red	50 2
F35/200GR	3.9 US sm oz Polyester	Green	50 2
F35/200BU	3.9 US sm oz Polyester	Blue	50 2
F35/200YE	3.9 US sm oz Polyester	Yellow	50 2
F35/200BK	3.9 US sm oz Polyester	Black	50 2
F35/300RD	3.9 US sm oz Polyester	Red	76 3
F35/300GR	3.9 US sm oz Polyester	Green	76 3
F35/300BU	3.9 US sm oz Polyester	Blue	76 3
F35/300BK	3.9 US sm oz Polyester	Black	76 3

#### Page Navigation

**Repair & Seaming Tapes:**  
Please turn to page 112-115  
for full details.



### Folded Tape

- ▲ Pre-folded slit tape can be prepared from most polyester or nylon slit tapes.
- ▲ The folded tapes are placed on special reels to facilitate easy storage and handling.
- ▲ Price quoted covers folding only.
- ▲ Return each reel for a \$0.50 credit.

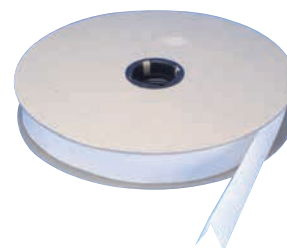

Part No.	Description
FOLD	Range of folded tapes - 3.9 ounces up to 8.0 ounces. Flat tape 1 1/2" to 6" width folds up to 3/4" to 3"



### Braided Polyester Leechline

- ▲ Low stretch line that keeps its round shape under load. Grips well in clamcleats or other v-jamb cleats.



Part No.	Size	Diameter: mm/in	Reel Size: m/ft
E330	40	1.2 3/16	305 1,000
E331	50	1.6 1/4	305 1,000
E332	205	2.0 5/16	305 1,000
E334	505	3.0 1/8	305 1,000
E335	705	4.2 5/8	183 600

### Yale ULS Double Braid Line

- ▲ **Construction:** Braided polyester cover, braided 24 strand polyester core.

- ▲ **Colors:** White with colored tracer: (black, navy, red, green). Solid cover: (black, navy, red, green) with white tracer.

- ▲ Improved strength and lower stretch. Firm, yet easily spliceable rope that allows for good handling.



Part No.	Weight Lbs/100ft	Weight Kg/100m	Diameter: mm/in	Strength: Lbs/Kg
YUL12**	1.10	1.64	5 3/16	1000 453.60
YUL16**	2.20	3.27	6 1/4	2100 952.56
YUL20**	3.50	5.21	8 5/16	4400 1995.81
YUL24**	5.00	7.44	9 3/8	5600 2540.12
YUL28**	6.30	9.38	11 7/16	7400 3356.58
YUL32**	8.80	13.10	12 1/2	9600 4354.49
YUL36**	11.60	17.26	14 9/16	11100 5034.96
YUL40**	14.10	20.98	16 5/8	14900 6758.64

### 3-Strand Spun Polyester

- ▲ Manufactured by New England Ropes.
- ▲ Line has moderate stretch with very good recovery, specifically engineered for use in luff of sails.



Part No.	Diameter: mm/in	Reel Size: m/ft
E320	4.8 3/16	366 1,200
E321	6.3 1/4	366 1,200
E322	7.9 5/16	183 600
E323	9.5 3/8	183 600
E324	11.1 7/16	183 600
E325	12.5 1/2	183 600

### Nylon Diamond Braid Utility Cord

- ▲ Braided filament nylon utility cord that is easily knotted or sewn for draw string or tie down.
- ▲ Available only on full rolls.
- ▲ Very soft hand.



Part No.	Size - Style	Diameter: mm/in	Reel Size: m/ft
E307	5-Soft Nylon	4.2 5/32	914 3,000

### Solid Braid Polyester Cord

- ▲ Solid braid are made from continuous filament, high tenacity yarns. Solid braid (lockstitch) construction offer excellent abrasion resistance, maintains uniform diameter and are superior to Diamond braid.
- ▲ Resists UV rays. Best for marine and outdoor use.



Part No. White	Part No. Black	Size	Diameter: mm/in	Reel Size: m/ft
E350P	E350PBK	4	3.0 1/8	305 1,000
E358P	-	5	3.9 5/32	305 1,000
E352P	E352PBK	6	4.8 3/16	305 1,000
E354P	E354PBK	8	6.3 1/4	305 1,000
E356P	-	10	7.9 5/16	152 500
E357P	-	12	9.5 3/8	152 500

### Fairlead Cleats (For Ropes to 6mm/1/4")

▲ Can hold heavy banners and flags.



CL253AN

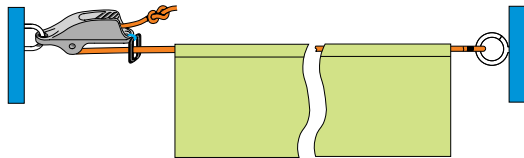

Part No.	Style	Diameter: mm/in	Pack Quantity
CL-253AN	Aluminum	4-8 5/32-5/16	10

### Power Grip Cleats

▲ Use on draw strings for bags.  
▲ Two-part simple cam action.



CL261



CL262

Part No.	Size - Style	Diameter: mm/in	Pack Quantity
CL261	Power Grip 1 (Alum.)	3-6 1/8-1/4	10
CL262	Power Grip 2 (Alum.)	3-6 1/8-1/4	10

### Sperry Cleat

▲ The Sperry cleat is a simple one-handed tensioning device.  
▲ Made from high grade, UV resistant nylon.  
▲ Allows for easy re-adjustment with strong holding power.  
▲ Use on tents, fenders, tie downs.

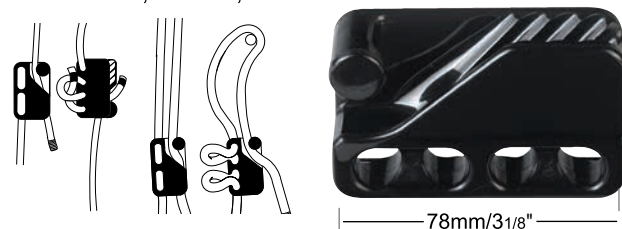

78mm/3 1/8"

Part No.	Size - Style	Diameter: mm/in	Pack Quantity
A083BK	CL-234	6-7 1/4-1/2	10

### Aero Cleat

▲ Easy to rig and adjust. The position of the cleat on the rope can be adjusted by hand. No tools required.



CL827-03

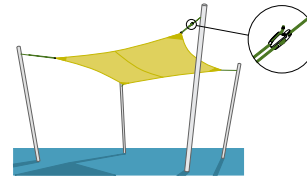

Part No.	Style	Diameter: mm/in	Pack Quantity
CL826-11AN	Hard Anodized	4-6 5/32-1/4	10
CL827-03	Nylon Junior	4-6 5/32-1/4	10

### Vertical Clamcleats

▲ A064 vertical cleat has an integral fairlead channel.  
▲ Attach with rivets, bolts and nuts or sew on.  
▲ Allows quick and easy adjustment.  
▲ Manufactured from high strength black plastic.

A064 (CL203)

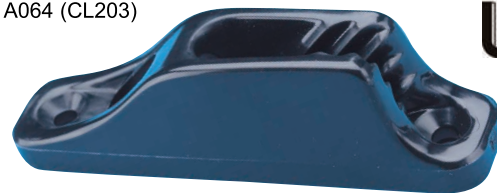

82mm/3 1/4"

Part No.	Style	Diameter: mm/in	Reel Size: m/ft
A064	CL203	4.2 5/32	914 3,000

### Line-Lok Clamcleats

▲ Use on biminis, sun awnings and camping guy ropes.  
▲ Manufactured from high impact UV resistant nylon.  
▲ Grips the line to resist being shaken loose.  
▲ Weight: 220g/0.08oz.

A080BK (CL260)



32mm/1 1/4"

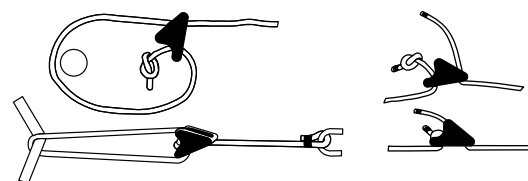

Part No.	Style	Diameter: mm/in	Pack Quantity
A080BK	CL-260	2-5 5/64-3/16	10

## Shockcord

- ▲ Nylon covered synthetic rubber for longer life.
- ▲ Available only on full reels.

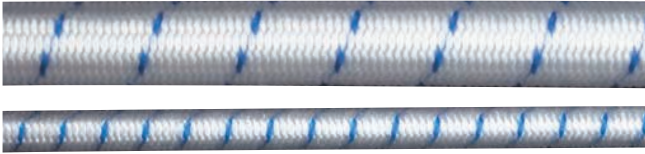

Part No.	Color	Diameter: mm/in		Length Per Reel: m/ft	
E373	White	3	1/8	91.4	300
E373BK	Black	3	1/8	91.4	300
E375	White	5	3/16	91.4	300
E376	White	6	1/4	91.4	300
E378	White	8	5/16	45.7	150
E380	White	10	3/8	45.7	150

## Colored Shockcord

- ▲ Polyester covered synthetic rubber for longer life.
- ▲ Available only on full reels of 250 feet/ 76 meters.
- ▲ Five Colors: Black, Blue, Green, Red, Yellow
- ▲ Five Diameters: 1/8", 3/16", 1/4", 5/16", 3/8"



Part No.	Color	Diameter: mm/in		Length Per Reel: m/ft	
ES125BK	Black	3.175	1/8	76	250
ES125BU	Blue	3.175	1/8	76	250
ES125GRN	Green	3.175	1/8	76	250
ES125RD	Red	3.175	1/8	76	250
ES125YE	Yellow	3.175	1/8	76	250
ES187BK	Black	4.762	3/16	76	250
ES187BU	Blue	4.762	3/16	76	250
ES187GRN	Green	4.762	3/16	76	250
ES187RD	Red	4.762	3/16	76	250
ES187YE	Yellow	4.762	3/16	76	250
ES250BK	Black	6.350	1/4	76	250
ES250BU	Blue	6.350	1/4	76	250
ES250GRN	Green	6.350	1/4	76	250
ES250RD	Red	6.350	1/4	76	250
ES250YE	Yellow	6.350	1/4	76	250
ES312BK	Black	7.938	5/16	76	250
ES312BU	Blue	7.938	5/16	76	250
ES312GRN	Green	7.938	5/16	76	250
ES312RD	Red	7.938	5/16	76	250
ES312YE	Yellow	7.938	5/16	76	250
ES375BK	Black	9.525	3/8	76	250
ES375BU	Blue	9.525	3/8	76	250
ES375GRN	Green	9.525	3/8	76	250
ES375RD	Red	9.525	3/8	76	250
ES375YE	Yellow	9.525	3/8	76	250

Shock Cord

## Cord Lock

- ▲ Use on draw strings for bags.
- ▲ Two-part simple cam action.

A106BK

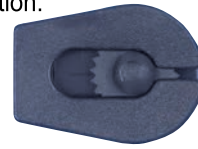

Part No.	Color	Maximum Cord Size: mm/in		Pack Qty
A106BK	Black	3	1/8	100

## Barrel Lock

- ▲ Simple cord locking device designed with a positive locking stainless steel spring holds the cord tight.
- ▲ Use on draw strings, small sailbags to lock cord.

A105



Part No.	Maximum Cord Size: mm/in		Pack Qty
A105	6.3	1/4	100

## Plastic Shock Cord End

- ▲ Fits 1/4" shock cord.
- ▲ Use for tie down cords etc.



Part No.	Cord Diameter: mm/in	Length: mm/in	Color	Pack Qty
A147BK	6 1/4	33 1 5/16	Black Delrin	100

## Shock Cord to Webbing Connector

- ▲ Connector to link 1/4" shock cord to 1" webbing.
- ▲ Pack quantity: 100 pieces.

A154BK



Part No.	Cord Diameter: mm/in	Length: mm/in	Color	Pack Qty
A145BK	6 1/4	38 1	Black Delrin	100

## Shockcord Pliers

- ▲ For closing clamps B449 - B453.



Part No.	Description
C449	Clamp Pliers



### Stainless Steel Shockcord Hooks

▲ Place shockcord through bottom hole. Squeeze shock cord clamp tightly.

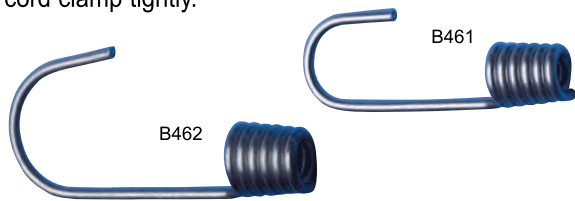

Part No.	For Cord Diameter: mm/in	Length:	Pack Qty
B461	6 1/4	50 2	50
B462	8 5/16	62 2 1/2	50

### Plastic Shockcord Hooks

▲ White nylon.

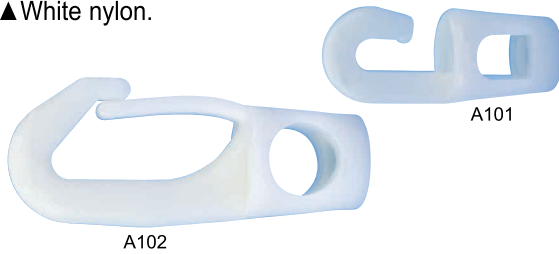

Part No.	For Cord Diameter: mm/in	Length:	Pack Qty
A101	3 - 6 1/8 - 1/4	36 1 7/16	100
A102	8 - 10 5/16 - 3/8	63 2 1/2	100

### Plastic Locking Shock Cord Hook

Two-part hook with locking cover secures shock cord to hook without separate clamps or knots

▲ Use for tie down cords.



Part No.	Cord Diameter: mm/in	Length: mm/in	Color	Pack Qty
A140	6 1/4	45 1 3/4	Black Delrin	100
A141	8 5/16	73 2 7/8	Black Nylon	50

### Shockcord Clamps

▲ Stainless steel clamps.- use C449 Pliers to apply.

▲ Available only in full packs of 100.

▲ Order quantity: 1 full pack equals 100 clamps.

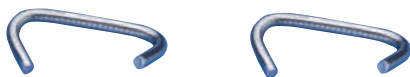

Part No.	For Cord Diameter: mm/in	Size
B449	3 - 5 1/8 - 3/16	X00
B450	6 1/4	X0
B451	8 5/16	X1
B452	10 3/8	X2
B453	12 1/2	X3

### "S" Hook Shockcord Hooks

▲ Stainless steel wire.



Part No.	Wire Diameter: mm/in	Length: mm/in	Pack Qty
B463	3.2 1/8	31 1 1/4	100
B464	4.8 3/16	44 1 3/4	100

### Shock Cord Lacing Knob

Used with a cord cover clip for a fast and simple tie-down.

▲ Attaches with a screw.



Part No.	Cord Diameter: mm/in	Knob Diameter: mm/in	Color	Pack Qty
G045BK	5 3/16	18 1 1/16	Black	100
G045WT	5 3/16	18 1 1/16	White	100

### Sew-on Cover Hooks & Eyelets - Plastic

▲ Injection molded in nylon.

▲ Sew through plastic with straight stitch sewing machine.

▲ Can be used alone or together.

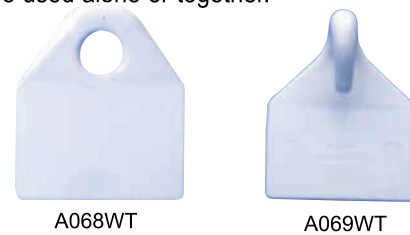

Part No.	Description	Color	Pack Qty
A069BK	Hook	Black	100
A069WT	Hook	White	100
A068BK	Eyelet	Black	100
A068WT	Eyelet	White	100

### Adjustable Shock Cord Hook

▲ Adjust from 3/16" to 5/16" shock cord.

▲ Use for tie down cords etc.



Part No.	Cord Diameter: mm/in	Length: mm/in	Color	Pack Qty
A103BK	5 - 8 3/16" - 5/16"	68	2 3/4" Black Delrin	100

## Sew On Eyelet

- ▲ Allow quick and easy attachment on dodgers to guard rails, marques, tents and awning structures.
- ▲ A172 has integral roller wheel for reduced drag on the shock cord.

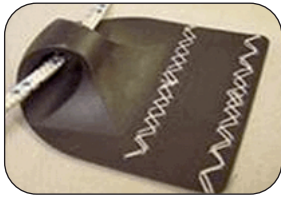

A170



A172

Part No.	Description	Pack Quantity
A170	Black Nylon Sew-On Eyelet	10
A172	Black Nylon Sew-On Eyelet with Roller Wheel	10

## Inflatable Boat Hook

- ▲ Rigid plastic boat hook.
- ▲ Manufactured from white nylon.
- ▲ Accepts 1/8" to 1/4" shock cord.



P44015

Part No.	Description	Pack Quantity
P44015	White Nylon Rigid Boat Hook	10



## Solid Stainless Steel Thimbles

- ▲ Stainless Steel.

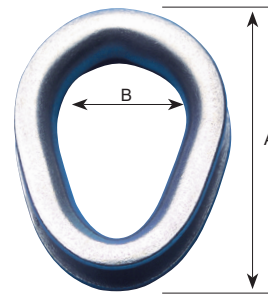

Part No.	External Length A: mm/in	Inside Diameter B: mm/in	Wire Diameter: mm/in	Pack Qty
B153	28 1 1/8	12 7/16	3 1/8	50
B154	33 1 3/8	15 9/16	4 5/32	25
B155	36 1 7/16	18 11/16	5 3/16	25
B156	48 1 7/8	20 3/4	6 1/4	25
B158	56 2 1/4	24 1	8 5/16	25

## Heavy Duty Split Stainless Steel Thimbles

- ▲ Stainless Steel.

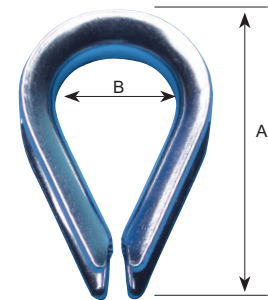

Part No.	External Length A: mm/in	Inside Diameter B: mm/in	Wire Diameter: mm/in	Pack Qty
B133	24 15/16	10 3/8	3 1/8	50
B134	26 1	12 7/16	4 5/32	50
B135	32 1 1/4	14 9/16	5 3/16	50
B136	39 1 1/2	16 5/8	6 1/4	50
B137	45 1 3/4	20 13/16	7 5/16	25
B138	51 2	22 7/8	8 3/8	25

## Seizing Wire

- ▲ 1 x 7 annealed stainless steel seizing wire.
- ▲ Sold in full reels only.



Part No.	Diameter: mm/in	Reel Length: m/ft
B556	1.6 1/16	152 500

### Self-Piercing Grommets & Washers

Self-piercing grommets eliminate the need for hole punches, since the grommet cuts its own hole when being set. Increases speed and production efficiency. Saves time and frustration. Recommended for use in most industrial applications. Just load, pierce and set!

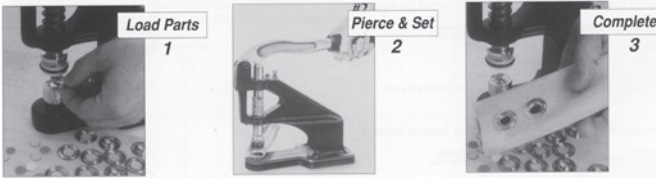

Top die holds grommet firmly

Grommet cuts its own hole and special grooved washer controls roll over for a smooth secure fit.

Saves time and frustration! Recommended for use in most industrial applications.

### Self-Piercing Grommets/Washers

- ▲ Grommets and washers are sold as sets, and are available in brass, nickel plated brass or stainless steel.
- ▲ Manufactured from brass with a lacquer finish.
- ▲ Self-piercing grommets and washers are sold in full boxes only.



Part No.	Material	Size/Mfg #	Inside Diameter: mm/in
D101B	Brass	1 230	8 5/16
D102B	Brass	2 250	10 3/8

### Self-Piercing Grommets/Washers - Nickel

- ▲ Manufactured from nickel plated brass with sharpened ground edge for penetrating into more difficult materials.
- ▲ Self-piercing grommets and washers are sold in full boxes only. 100 sets per box.



Part No.	Material	Size/Mfg #	Inside Diameter: mm/in
D111N	Nickel Plated Brass	1 230	8 5/16
D112N	Nickel Plated Brass	2 250	10 3/8
D113N	Nickel Plated Brass	3 280	11 7/16

### Self-Piercing Grommets/Washers Stainless Steel

- ▲ Manufactured from stainless steel, which is sharper and stronger than either of the afore mentioned styles.
- ▲ Self-piercing grommets & washers are sold in full boxes only.



Part No.	Material	Size/Mfg #	Inside Diameter: mm/in
D112SS	Stainless Steel	2 250	10 3/8

### Press-n-Snap Dies for Self-Piercing Grommets/Washers

- ▲ Self-holding press-n-snap grommet die sets for use with self-piercing grommets and washers.

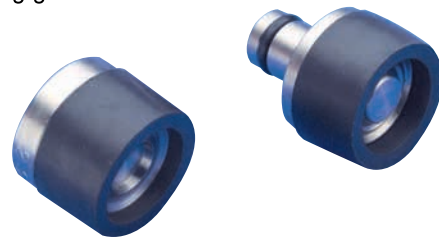

Part No.	Use With Size/Mfg #
C366	1 230
C367	2 250

### Bench Press Dies for Self-Piercing Grommets/Washers

- ▲ Self-holding bench press grommet die sets for use with self-piercing grommets and washers
- ▲ May be used with most US presses with 3/8 inch diameter shank.
- ▲ Note: Bench press dies are only available to special order.



Part No.	Use With Size/Mfg #
C631	1 230
C632	2 250
C633	3 280

### Important Note

▲ Self-piercing grommets can only be set with self-piercing grommet dies. Neither plain washer nor spur grommet dies will work.



## English Rolled Rim Grommets with Spur Toothed Washers

▲ These grommets are sold in full packs only. 200 pieces per pack.



Part No.	Material	Size Reference	Inside Diameter: mm/in	
D001BH	Brass	000	5	$\frac{3}{16}$
D002BH	Brass	00	6	$\frac{1}{4}$
D002NH	Nickel	00	6	$\frac{1}{4}$

## Closing Tools for English Grommets

▲ Tools for English Grommets cannot be used with Stimpson Grommets.

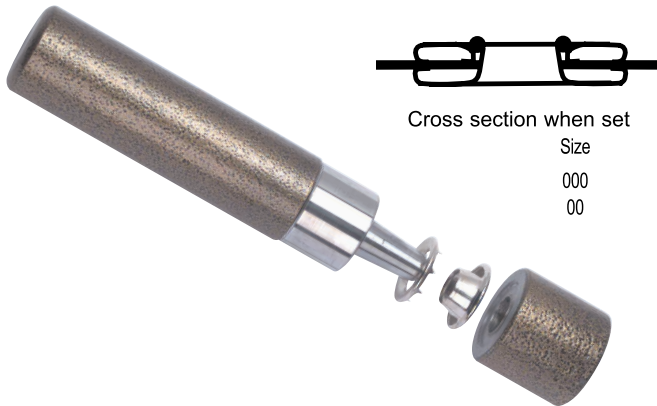

Cross section when set  
Size  
000  
00

Part No.	Size
C301	000
C302	00

## Hole Punch and Closing Tool Data for English Grommets

Part No.	Size	Hole Punch Diameter: mm/in	Hole Punch	Closing Tool
D001BH	000	4.8 $\frac{3}{16}$	C181	C301
D002BH/NH	00	7.9 $\frac{5}{16}$	C182	C302

## Hole Punch and Closing Tool Data for Plain Grommets

Part No.	Size	Hole Punch Diameter: mm/in	Hole Punch	Closing Tool
D603B/N	0	6 $\frac{1}{4}$	C151	C603
D604B/N	1	8 $\frac{5}{16}$	C152	C604
D605B/N	2	10 $\frac{3}{8}$	C153	C605
D606B/N	3	11 $\frac{1}{16}$	C154	C606
D607N	4	12 $\frac{1}{2}$	C155	C607

## Hole Punch and Closing Tool Data for Stimpson Grommets

Part No.	Size	Hole Punch Diameter: mm/in	Hole Punch	Closing Tool
D003BS/NS	0	9.5 $\frac{3}{8}$	C152	C303S
D004BS/NS	1	11.1 $\frac{7}{16}$	C153	C304S
D005BS/NS	2	12.7 $\frac{1}{2}$	C154	C305S
D006BS/NS	3	14.3 $\frac{9}{16}$	C155	C306S
D007BS/NS	4	15.9 $\frac{5}{8}$	C156	C307S
D008BS/NS	5	17.5 $\frac{11}{16}$	C157	C308S
D009BS/NS	6	22.2 $\frac{7}{8}$	C158	C309S

## Stimpson Plain Rim Grommets with Plain Washers



▲ These grommets are sold by the gross (144 sets/gross).  
Special order products - minimum order



Part No.	Material	Size Reference	Inside Diameter: mm/in	
D603B	Solid Brass	0	6	$\frac{1}{4}$
D604B	Solid Brass	1	8	$\frac{5}{16}$
D605B	Solid Brass	2	10	$\frac{3}{8}$
D606B	Solid Brass	3	11	$\frac{7}{16}$
D603N	Solid Brass/Nickel Finish	0	6	$\frac{1}{4}$
D604N	Solid Brass/Nickel Finish	1	8	$\frac{5}{16}$
D605N	Solid Brass/Nickel Finish	2	10	$\frac{3}{8}$
D606N	Solid Brass/Nickel Finish	3	11	$\frac{7}{16}$
D607N	Solid Brass/Nickel Finish	4	12	$\frac{1}{2}$

## Closing Tools for Plain Grommets

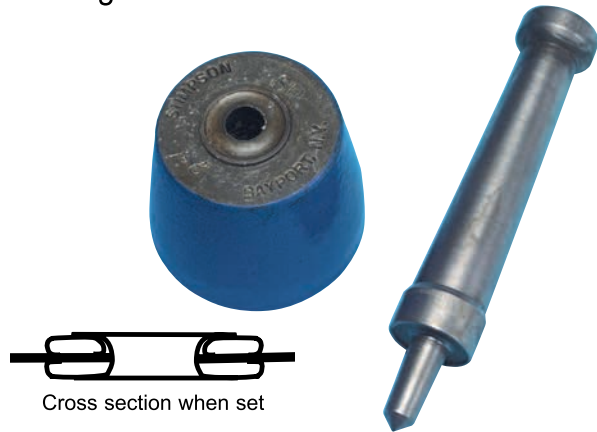

Cross section when set

Part No.	Size
C602S	00
C603S	0
C604S	1
C605S	2
C606S	3
C607S	4

## For Maximum Performance and service:

- ▲ Do not try to set grommet with one blow. Using Maul Master (C233/4) tap lightly at first, increasing strength of blow until grommet is set.
- ▲ Do not strike at an angle or attempt to dislodge a top set which has become wedged in a bottom die through over setting by striking a sharp blow on the side of the handle. Such misuse will cause the top set point to break, bottom set insert to chip, or both.
- ▲ Clean dies and lubricate periodically with Teflon Spray (M005).



Page Navigation

Hole Punches & Hammers  
Please see Page 137 for  
full details.



## Stimpson Spur-Toothed Grommets - Brass & Nickel Finishes

The higher strength of these spur-toothed grommets derives from their thicker metal gauge, and flange closing.

▲ Available only in full packs of 1 gross (144 sets/gross).



Brass

Part No.	Size	Set Hole Diameter: mm/in		Pack Qty
D003BS	0	6.4	1/4	144
D004BS	1	9.5	3/8	144
D005BS	2	10.3	13/32	144
D006BS	3	11.1	7/16	144
D007BS	4	14.2	9/16	144
D008BS	5	15.0	19/32	144
D009BS	6	17.4	11/16	144



Nickel

Part No.	Size	Set Hole Diameter: mm/in		Pack Qty
D003NS	0	6.4	1/4	144
D004NS	1	9.5	3/8	144
D005NS	2	10.3	13/32	144
D006NS	3	11.1	7/16	144
D007NS	4	14.2	9/16	144
D008NS	5	15.0	19/32	144
D009NS	6	17.4	11/16	144

## Closing Tools for Stimpson Grommets

▲ Stimpson Grommets cannot be used with English Grommet tools.

▲ Stimpson tools are machined steel case hardened dies.

▲ Low-cost tools are drop forged steel dies.



Cross section when set



Stimpson Part No.	Low Cost Tool Part No.	Size
C303S	C303MS	0
C304S	C304MS	1
C305S	C305MS	2
C306S	C306MS	3
C307S	C307MS	4
C308S	C308MS	5
C309S	c309MS	6

Stimpson Grommets



Established 1852

ISO 9001 Certified  
RoHS • REACH • DFARS Compliant



Stimpson Grommets and Washers are available in brass, zinc, aluminum, and with popular finishes such as nickel and dull black chemical. Many sizes are also available in stainless steel.

All Stimpson Grommets and Washers meet the latest military and commercial specifications and are supported by a full line of grommeting machines.





### Stainless Steel Welded Hardware

All Bainbridge International welded stainless steel fittings are manufactured from high grade stainless steel, which is chemically cleaned and passivated after welding to reduce the risk of staining. TIG welding maximizes strength.



### Round Rings

- ▲ High grade stainless steel.
- ▲ TIG welded.
- ▲ Small diameter rings with the same size bar diameter will deform at a higher load although both will have similar tensile strength.
- ▲ B223 & B224 are available to special order only.



Special order products.

Part No.	Inside Diameter: mm/in	Bar Diameter: mm/in	Weight: gm/oz	Safe Working Load: kg/lb
B214	25 1	4.8 3/16	14 0.5	300 700
B227	25 1	6.3 1/4	21 0.7	800 1800
B118	32 1 1/4	4.8 3/16	16 0.6	150 350
B117	32 1 1/4	6.3 1/4	28 1.0	600 1300
B228	32 1 1/4	7.9 5/16	49 1.7	1000 2200
B119	38 1 1/2	6.3 1/4	35 1.2	400 900
B219	38 1 1/2	7.9 5/16	57 2.0	750 1600
B229	38 1 1/2	9.3 3/8	85 3.0	1300 2800
B121	44 1 3/4	7.9 5/16	64 2.3	900 2000
B120	51 2	6.3 1/4	42 1.5	350 800
B220	51 2	7.9 5/16	71 2.5	550 1200
B221	51 2	9.3 3/8	106 3.7	1000 2200
B225	51 2	11.1 7/16	149 5.3	2300 5000
B223	64 2 1/2	9.3 3/8	127 4.5	750 1600
B224	76 3	7.9 5/16	106 3.7	250 550

### "D" Rings

- ▲ High grade stainless steel.
- ▲ TIG welded.



Part No.	Inside Width: mm/in	Bar Diameter: mm/in	Weight: gm/oz	Safe Working Load: kg/lb
B170	25 1	4.8 3/8	14 0.5	300 700
B171	31 1 1/4	4.8 3/8	18 0.6	300 700
B172	38 1 1/2	4.8 3/8	21 0.7	300 700
B173	51 2	4.8 3/8	23 0.8	150 350
B174	51 2	6.3 1/4	42 1.5	500 1100
B175	60 2 3/8	7.9 5/8	64 2.3	700 1500



### "D" Rings with Bar

- ▲ High grade stainless steel.
- ▲ TIG welded.
- ▲ Reinforcing bar reduces potential distortion under high load and inhibits D-ring from rotating.



Part No.	Inside Width: mm/in	Bar Diameter: mm/in	Weight: gm/oz	Safe Working Load: kg/lb
B174B	51 2	6.3 1/4	57 2	1300 2900

### Triangles

- ▲ High grade stainless steel.
- ▲ TIG welded.
- ▲ Reinforcing bar reduces potential distortion under high load and inhibits D-ring from rotating.



B127



B127B

Part No.	Inside Width: mm/in	Bar Diameter: mm/in	Weight: gm/oz	Safe Working Load: kg/lb
B127	51 2	6.3 1/4	49 1.7	500 1100
B127B	51 2	6.3 1/4	57 2.0	1000 2200

### Maxi Rings

- ▲ Reinforcing bar reduces distortion under high load.
- ▲ High grade stainless steel.
- ▲ TIG welded.



Part No.	Inside Width: mm/in	Bar Diameter: mm/in	Weight: gm/oz	Safe Working Load: kg/lb
B229B	38 1 1/2	9.3 3/8	106 3.7	2600 5700
B221B	51 2	9.3 3/8		
B225B	51 2	11.1 7/16	191 6.7	4000 8800
B226B	64 2 1/2	12.7 1/2	298 10.5	4500 9900
B218B	76 3	15.8 5/8	568 20.1	10000 22000

### Clew Pieces

- ▲ High grade stainless steel.
- ▲ TIG welded.
- ▲ Distinctive pattern incorporates high strength with slots to secure webbing and prevents ring from rotating.



Part No.	Inside Width: mm/in	Bar Diameter: mm/in	Weight: gm/oz	Safe Working Load: kg/lb
B123	51 2	7.9 5/16	99 3.5	850 1900
B124	64 2 1/2	9.3 3/8	156 5.5	1000 2200
B125	76 3	11.1 7/16	276 9.8	2800 6200
B126	96 3 3/4	12.7 1/2	446 15.8	3800 8400
B122	4 1/4	5/8		

### Clew Piece with Bar/Diamond D Rings

- ▲ The unique design enables webbing to be aligned with the stress lines of the sail.
- ▲ High grade stainless steel with TIG welds to yield maximum strength.
- ▲ Much stronger than mild steel version.



 Special order products.

Part No.	Inside Width: mm/in	Bar Diameter: mm/in	Safe Working Load: kg/lb
B164	65 2 5/8	10 3/8	2000 4500
B165	75 3	11 7/16	3000 6600

### Cast 17-4 Stainless Steel Sail Rings

Unique computer design combined with high performance cast 17-4 stainless steel construction.

- ▲ Lighter and stronger than conventional equivalent welded rings.
- ▲ Cast construction eliminates weld weak point.
- ▲ Made from 17-4 stainless steel, higher SWL than 316.
- ▲ Elliptical cross-section and strengthening bar increase stiffness.
- ▲ Easy to web to sail.
- ▲ Can accommodate multiple sheets during sail or sheet point changes.



Part No.	Length: mm/in	Width: mm/in	Bar Diameter: mm/in	Weight: gm/oz	Safe Working Load: kg/lb
B248	74 2 15/16	58 2 5/16	9.3 x 6.4 3/8 x 1/4	73 2.6	2000 4400
B250	92 3 5/8	72 2 7/8	10.5 x 7.2 7/16 x 5/16	126 4.4	3000 6600

Page Navigation

Nylon & Polyester Webbing  
See Page 106-109

Ropes, Cord & Shock Cord  
See Page 92-94



Economy Welded Hardware

Bainbridge International economy welded rings are intended for low load applications.



Nickel Plated Steel O Rings - Welded

- ▲ Economy rings designed for low load applications.
- ▲ Use on bags, soft sided luggage.



Part No.	Inside Diameter: mm/in	Bar Diameter: mm/in	Pack Qty
B191	25 1	5 3/16	100

Nickel Plated Steel D Rings - Welded

- ▲ Economy rings designed for low load applications.



Part No.	Inside Diameter: mm/in	Bar Diameter: mm/in	Pack Qty
B196	25 1	4 5/32	100
B197	38 1 1/2	5 3/16	100
B198	50 2	6 1/4	50

Stainless Steel O Rings - Welded

- ▲ Economy rings designed for low load applications.



Part No.	Inside Diameter: mm/in	Bar Diameter: mm/in	Pack Qty
B204	25 1	3 1/8	100



Caution!

Economy welded rings are suitable for use on covers, awnings, bags and straps. They are NOT suitable as sail rings, or for use on safety harnesses, lifelines or jackstays.

Stainless Steel D Rings - Welded

- ▲ Economy rings designed for low load applications.



Part No.	Inside Diameter: mm/in	Bar Diameter: mm/in	Pack Qty
B169	25 1	5 3/16	100
B174	51 2	6.3 1/4	50

Snap Hooks - Carabiner

- ▲ Carabiner snaps ("Fireman hook") with spring loaded jaw, in economy steel.
- ▲ Economy Steel - for use on banners, key rings, buckets, etc.
- ▲ Warning: Carabiner Snap Hooks should not be used for high load applications such as emergency safety equipment.
- ▲ Note: These products are only available to special order. Please call for details.

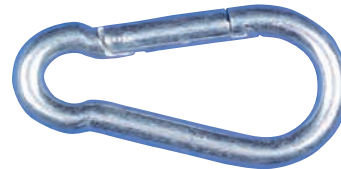

Part No.	Material	Dim. (a): mm/in	Dim. (b): mm/in	Pack Qty
B650	Economy Steel	50 2	5 3/16	25
B651	Economy Steel	60 2 3/8	6 1/4	25
B652	Economy Steel	80 3 1/4	8 5/16	25
B651S	Stainless Steel	60 2 3/8	6 1/4	25

Stainless Steel Quick Link

- ▲ Barrel bolt closes with fingers.
- ▲ Used for joining chain links or rings.



Part No.	Inside Diameter: mm/in	Bar Diameter: mm/in	Pack Qty
B7446	58 2 1/4	6 1/4	25



### Snap Hooks - Oval Eye

- ▲ Brass snap hooks are all purpose hookS used in many applications where loads are relatively low.
- ▲ Stainless steel offers the same efficient and easy to use shape, but has much greater safe working loads.



Part No.	Material	Type	Length: mm/in	Inside Eye Dia: mm/in	Pack Qty
B610	Brass	0	53 2 1/8	10 3/8	50
B611	Brass	1	72 2 7/8	15 5/8	50
B611N	Brass/Nickel Plate	1	72 2 7/8	15 5/8	50
B612	Brass	2	81 3 1/4	20 3/4	50
B610S	Stainless Steel	0	53 2 1/8	10 3/8	50
B611S	Stainless Steel	1	72 2 7/8	15 5/8	50
B612S	Stainless Steel	2	81 3 1/4	20 3/4	50

### Snap Hook - Rectangle Eye

- ▲ Stainless steel snap hooks are all purpose hooks used in many applications where loads are relatively low.
- ▲ Ideal for use with 25.4mm/1 inch webbing.



Part No.	Material	Length: mm/in	Inside Eye: mm/in	Pack Qty
B617S	Stainless Steel	50 2	25.4 1	50

### Swivel Snap Hooks

- ▲ Bronze snap hooks are all purpose hookS used in many applications where loads are relatively low. Stainless steel version is available for higher loads.
- ▲ Swivel prevents halyard from twisting.



Part No.	Material	Type	Length: mm/in	Inside Eye Diam mm/in	Pack Qty
B611SW	Bronze	1	81 3 1/4	15 5/8	50
B611SSW	Stainless Steel	1	81 3 1/4	15 5/8	50
B613SW	Bronze	2	81 3 1/4	20 3/4	50

### Snap Hooks - Swivel Eye

- ▲ Snap hooks are all purpose hookS used in many applications where loads are relatively low.



Part No.	Material	Length: mm/in	Inside Eye: mm/in	Pack Qty
B615	Bronze	75 3	10 3/8	50

### Snap Hook - Swivel Trigger



Part No.	Material	Length: mm/in	Inside Eye: mm/in	Pack Qty
B632	Bronze	64 2 1/2	10 3/8	50

### Snap Hooks - Swivel Eye for Webbing

- ▲ Rectangular webbing eye.
- ▲ Snap hooks are all purpose hooks used in many applications where loads are relatively low.

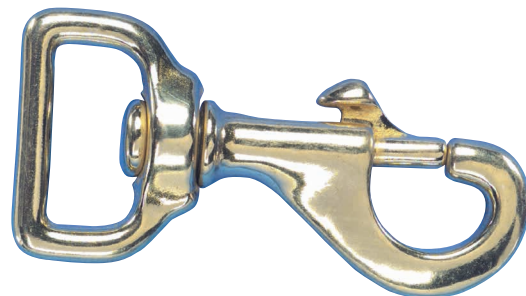

Part No.	Material	Length: mm/in	Inside Eye: mm/in	Pack Qty
B637	Bronze	75 3	25 1	50



**Caution!**

These snap hooks should NOT be used for high load applications such as emergency safety equipment.

Eye Straps

Note: Images are not to scale

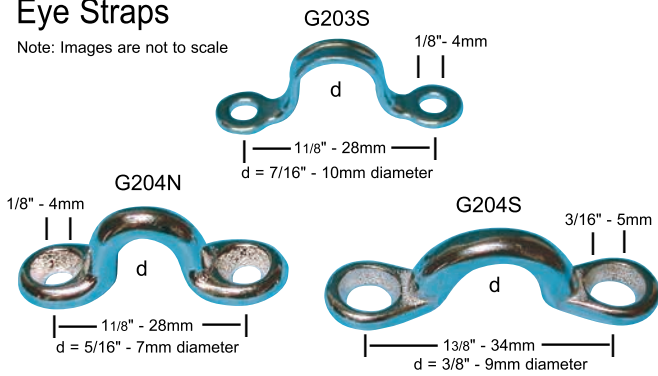

Part No.	Description	Pack Qty
G203S	Stamped Stainless Steel	100
G204N	Cast Nickel Plated Brass	100
G204S	Cast Polished Stainless Steel	100

Snap Hooks - Acetal Plastic

▲ Light weight and durable component system for detachable straps.

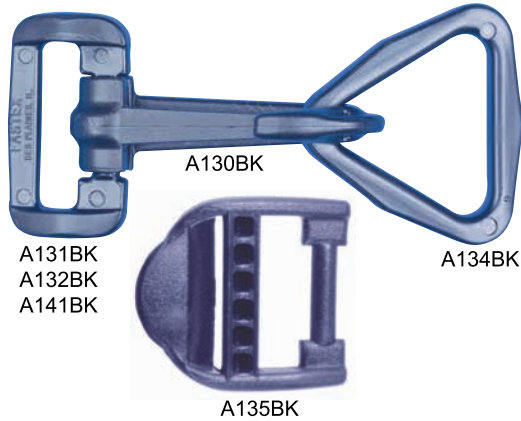

Part No.	For Webbing: mm/in	Description	Color	Pack Qty
A130BK	-	Hook	Black	50
A131BK	25 1	1 Inch Retainer	Black	50
A132BK	50 2	2 Inch Retainer	Black	50
A134BK	25 1	1 Inch Tri-Ring	Black	50
A135BK	25 1	1 inch Retainer	Black	50
A141BK	38 1 1/2	1 1/2 Inch Retainer	Black	50

Quick Release Swivel Buckle

▲ Stainless Steel, quick-release removable buckle with flush floor mounting.

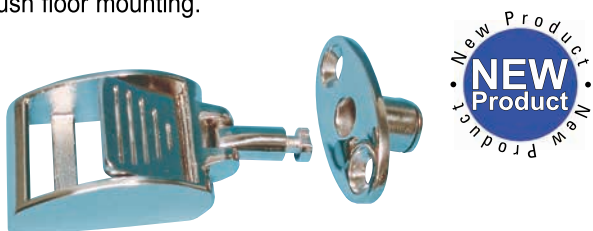

Part No.	For Webbing: mm/in	Material	Pack Qty
G742S	25 1	Stainless Steel	10

Quick Release Buckle

- ▲ Zinc plated/Stainless steel construction.
- ▲ Compatible with most styles of 25mm/1" webbing.
- ▲ Features "Quick-Release" fastener.
- ▲ Applications: Awning, Boat covers, adjustable tie-downs etc.



Part No.	Material	Inside Eye: mm/in	Pack Qty
G215S	Stainless Steel	25 1	50
G213ST	Zinc Plated Steel	25 1	50

Snap Hooks - For 1" Webbing

▲ G200S has rectangular eye for webbing.

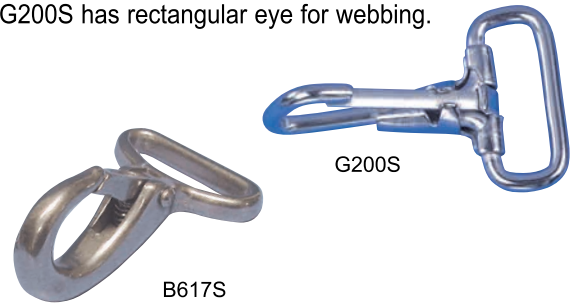

Part No.	Material	Length: mm/in	Inside Eye: mm/in	Pack Qty
G200S	Stainless Steel	50 2	25 1	100
B617S	Stainless Steel	50 2	25 1	100

Cam Buckles

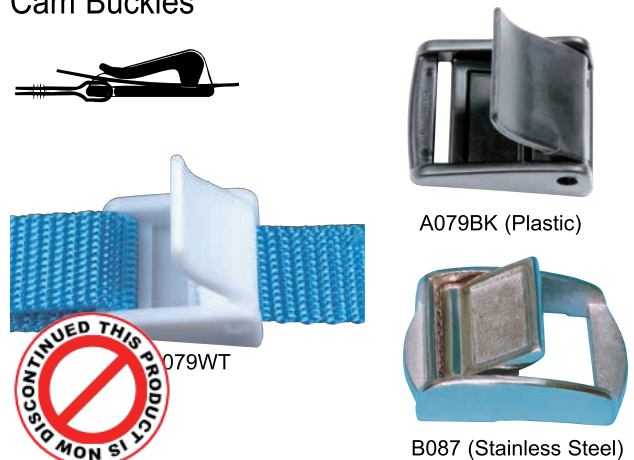

Part No.	For Webbing: mm/in	Material	Pack Qty
A078WT	19 3/4	White Nylon	100
A079BK	25 1	Black Nylon	100
A079WT	25 1	White Nylon	100
A072BK	50 2	Black Nylon	50
B087	25 1	Stainless Steel	50

## Loop Loc

▲ Ideal for holding straps or webbing where no adjustment is needed.



Part No.	For Webbing: mm/in	Material	Color	Pack Qty
A124BK	25 1	Acetal Plastic	Black	50

## Adjuster Buckles



G211S

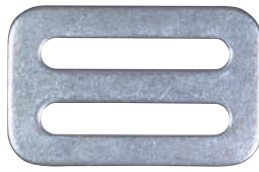

G210S

Part No.	For Webbing: mm/in	Material	Pack Qty
G211S	25 1	Stainless Steel	100
G210S	25 1	Stainless Steel	100

## Sliding Bar Buckles



G221



G221S



G222S

Part No.	For Webbing: mm/in	Material	Pack Qty
G221	25 1	Stainless Steel/Nylon	10
G221S	25 1	Stainless Steel	10
G222S	50 2	Stainless Steel	10

## Center Release Buckle

▲ 3/4" center release buckle.

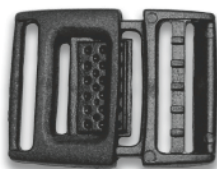

Part No.	For Webbing: mm/in	Material	Color	Pack Qty
A159BK	19 3/4	Acetal Plastic	Black	100

## Ladderlock Buckles

▲ A076HD is over three times the strength of standard 1" ladderlock.



A076



A076HD

Part No.	For Webbing: mm/in	Material	Pack Qty
A074	13 1/2	Black Nylon	100
A075	19 3/4	Black Nylon	100
A076	25 1	Black Nylon	100
A076HD	25 1	Heavy Duty Black Nylon	100
A077HD	50 2	Heavy Duty Black Nylon	100

## Tri Glide - Plastic



Part No.	For Webbing: mm/in	Material	Pack Qty
A122BK	25 1	Black Plastic	100
A142BK	38 1/2	Black Plastic	50
A125BK	50 2	Black Plastic	50

## Side Release Buckle

▲ A152BK is double adjustable, locking from both sides to eliminate the need to sew around the bar.



A152BK2 (Double Adjustable)



A089BK

Part No.	For Webbing: mm/in	Material	Pack Qty
A088BK	19 3/4	Black Nylon	50
A089BK	25 1	Black Nylon	50
A089WT	25 1	White Nylon	50
A098BK	38 1/2	Black Nylon	25
A099BK	50 2	Black Nylon	25
A152BK2	25 1	Black Nylon	50
A153BK	50 2	Black Nylon	50

## Woven Kevlar® Webbing

- ▲ Excellent for webbing on corner rings where no stretch is required.
- ▲ Kevlar is a very strong, low stretch fiber.
- ▲ Available only as full reels.



Part No.	Width: mm/in	Reel Length: m/yd	Breaking Strength: kg/lb	Color
E112KEV	25 1	46 50	2495 5500	Yellow

## Spectra®

- ▲ Lighter than Kevlar and does not absorb water.
- ▲ Excellent UV resistance and flex characteristics.
- ▲ Spectra is a very strong and low stretch fiber.
- ▲ Available only on full reels.



Part No.	Width: mm/in	Reel Length: m/yd	Breaking Strength: kg/lb	Color
E135SP	25 1	23 25	2500 5500	White
E139SP	45 1 3/4	24.7 27	4560 10,000	White

## Footman Loop - Webbing Bridge

- ▲ Stainless steel.



G205S

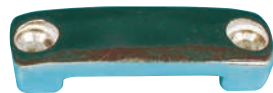

G209S

Part No.	Description	Width: mm/in	Pack Qty
G205S	Stainless Steel	25 1	50
G209S	Stainless Steel	25 1	50

## Extra Heavy Weight Nylon

- ▲ Available only on full reels.

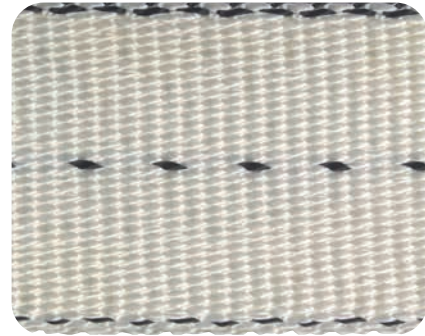

Part No.	Width: mm/in	Reel Length: m/yd	Breaking Strength: kg/lb	Color
E129HD	45 1 3/4	46 50	5035 11100	White

## Extra Heavy Weight Colored Nylon

- ▲ Ideal for safety straps, jacklines, where maximum safety is required.
- ▲ Premium quality, best against abrasion.
- ▲ Available only on full reels.

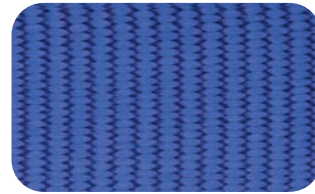

Part No.	Width: mm/in	Reel Length: m/yd	Breaking Strength: kg/lb	Color
E136WT	25 1	45 50	2721 6000	White
E136RB	25 1	45 50	2721 6000	Royal Blue

## Webbing Bridge

- ▲ Nylon
- ▲ Attaches to flat surfaces only.
- ▲ Available in 1" or 2" sizes.



A095WT



A097BK

Part No.	Description	Width: mm/in	Pack Qty
A095BK	Nylon Webbing Bridge - Black	25 1	50
A095WT	Nylon Webbing Bridge - White	25 1	50
A097BK	Nylon Webbing Bridge - Black	50 2	50
A097WT	Nylon Webbing Bridge - White	50 2	50

### Super Heavy Weight - Polyester Tubular

▲ Available only on full reels.

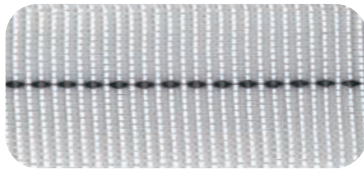

E124

Part No.	Width: mm/in		Reel Length: m/yd		Breaking Strength: kg/lb		Color
E124	25	1	46	50	1300	3000	White

### Super Heavy Weight - Nylon Tubular

▲ Available only on full reels.

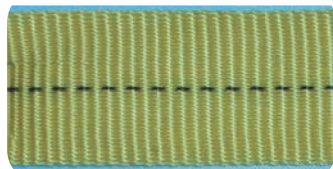

E124NYE

Part No.	Width: mm/in		Reel Length: m/yd		Breaking Strength: kg/lb		Color
E122	12	1/2	183	200	700	1550	White
E123	19	3/4	183	200	1200	2700	White
E124NBU	25	1	91	100	1800	4000	Blue
E124NBK	25	1	91	100	1800	4000	Black
E124NYE	25	1	91	100	1800	4000	Yellow
E124NRD	25	1	91	100	1800	4000	Red

### Extra Heavy Weight Polyester

▲ Available only on full reels.



Part No.	Width: mm/in		Reel Length: m/yd		Breaking Strength: kg/lb		Color
E121WT	50	2	25	27	2495	5500	White

### Soft Spun Polyester Tubular

- ▲ Soft hand tubular construction.
- ▲ Excellent for sail ties.
- ▲ Available only on full reels.



Part No.	Width: mm/in		Reel Length: m/yd		Breaking Strength: kg/lb		Color
E101	29	1 1/8	46	50	907	2000	White

### Heavy Weight Polyester

- ▲ Strong, low stretch webbing ideal for strapping rings on sails.
- ▲ Flat, non-tubular webbing.
- ▲ Excellent UV resistance.
- ▲ Very low stretch.



Part No.	Width: mm/in		Reel Length: m/yd		Breaking Strength: kg/lb		Color
E113	25	1	25	27	748	1650	White
E113BK	25	1	25	27	680	1500	Black
E115	38	1 1/2	25	27	998	2000	White
E116	50	2	25	27	1179	2600	White

### Seat Belt Style Polyester

- ▲ Rugged polyester webbing, recommended for hiking straps, bag handles, nose piece for kites, reinforcement, tie down, trampolines, etc.
- ▲ Excellent UV resistance.
- ▲ Available only on full reels.



E121BK

Part No.	Width: mm/in		Reel Length: m/yd		Breaking Strength: kg/lb		Color
E115BK	38	1 1/2	137	150	1134	2500	Black
E121BK	50	2	91	100	2268	5000	Black

## Colored Polypropylene Webbing

- ▲ Widths available: 1 inch, 1½ inch, 2 inch, 3 inch.
- ▲ Polypropylene webbing is solution dyed.
- ▲ Available only on full reels.



BK  
Black

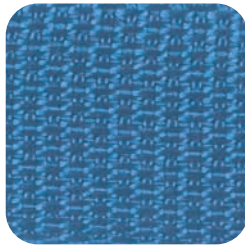

BU  
Blue



GR  
Green



GY  
Gray

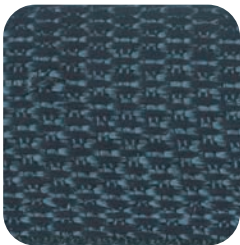

NB  
Navy Blue



RD  
Red



WT  
White



YE  
Yellow

### 1 Inch Standard Polypropylene Webbing

▲ Available only on full reels of 100 yds/91m.

Part No.	Width:		Reel Length:		Breaking Strength:		Color
	mm/in		m/yd		kg/lb		
E126WT	25	1	91	100	272	600	White
E126BU	25	1	91	100	272	600	Blue
E126RD	25	1	91	100	272	600	Red
E126GR	25	1	91	100	272	600	Green
E126YE	25	1	91	100	272	600	Yellow
E126BK	25	1	91	100	272	600	Black
E126NV	25	1	91	100	272	600	Navy
E126GY	25	1	91	100	272	600	Gray

- ▲ Note: Yellow is only available to special order and minimums may apply. Please call for more details.
- ▲ Note: Information correct at time of print. Other colors are available against special order.
- ▲ Color representation from 4-color process is for reference purpose only - please inquire for a color sample of actual fabric.

Page Navigation



Please turn back to pages 100-102 for more information on our range of "D" and "O" Rings.

### 1½ Inch Standard Polypropylene Webbing

▲ Available only on full reels of 100 yds/91m.

Part No.	Width:		Reel Length:		Breaking Strength:		Color
	mm/in		m/yd		kg/lb		
E143WT	38	1 ½	91	100	408	900	White
E143BK	38	1 ½	91	100	408	900	Black

### 2 Inch Standard Polypropylene

▲ Available only on full reels of 100 yds/91m.

Part No.	Width:		Reel Length:		Breaking Strength:		Color
	mm/in		m/yd		kg/lb		
E144WT	50	2	91	100	544	1200	White
E144BK	50	2	91	100	544	1200	Black

### 3 Inch Standard Polypropylene Webbing

▲ Available only on full reels of 100 yds/91m.

Part No.	Width:		Reel Length:		Breaking Strength:		Color
	mm/in		m/yd		kg/lb		
E132WT	75	3	91	100	816	1800	White

Note: Color representation from 4-color process is for reference purposes only. Please inquire for color sample of actual fabric.

### Heavy Weight - Colored Polypropylene

- ▲ Other colors are available against special order.
- ▲ Available only in full reels of 100 yds/91m.



BK  
Black



WT  
White

Part No.	Width: mm/in		Reel Length: m/yd		Breaking Strength: kg/lb		Color
E128WT	50	2	91	100	635	1400	White
E128BK	50	2	91	100	635	1400	Black

### Herringbone Pattern Polypropylene

- ▲ Can be used as a heavyweight binding or header.
- ▲ Available only in full reels of 100 yds/91m.

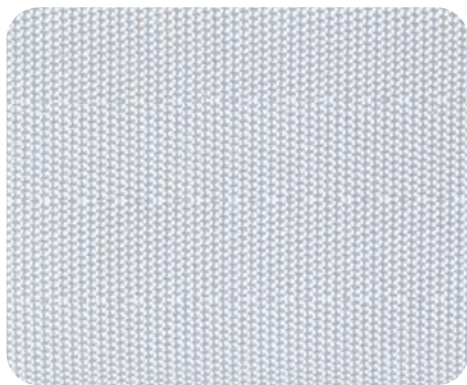

Part No.	Width: mm/in		Reel Length: m/yd		Breaking Strength: kg/lb		Color
E130	50	2	91	100	453	1000	White

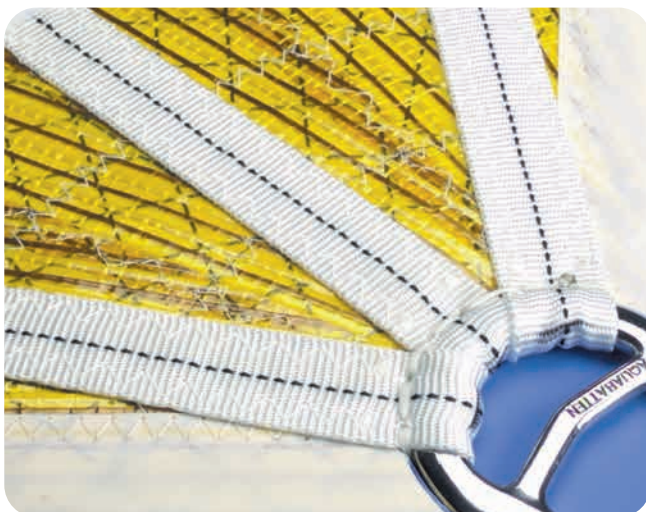

### Standard Weight Colored Nylon

- ▲ Our most popular flat webbing.
- ▲ Available only in full reels of 100 yds/91m.
- ▲ E110N/E110NBK - available on full reels of 50 yds/46m



BK  
Black



WT  
White

Part No.	Width: mm/in		Reel Length: m/yd		Breaking Strength: kg/lb		Color
E110N	12	1/2	46	50	317	700	White
E110NBK	12	1/2	46	50	317	700	Black
E111N	19	3/4	91	100	476	1050	White
E112N	25	1	91	100	680	1500	White
E112NBK	25	1	91	100	680	1500	Black
E113N	38	1 1/2	91	100	1020	2250	White
E114N	50	2	91	100	1360	3000	White
E114NBK	50	2	91	100	1360	3000	Black

 Dyed nylon fibers may not be totally color fast when damp or when used in humid conditions, or if in contact with materials containing free solvents, even in trace quantities.

**Caution!**

## Color Availability



## Polyester Insignia Cloth

- ▲ Standard style.
- ▲ Has grid on release liner.
- ▲ Cut lengths available.
- ▲ Kevlar is only a color description and is not aramid material.
- ▲ Approx. 3.9oz Sq Yd without the release paper

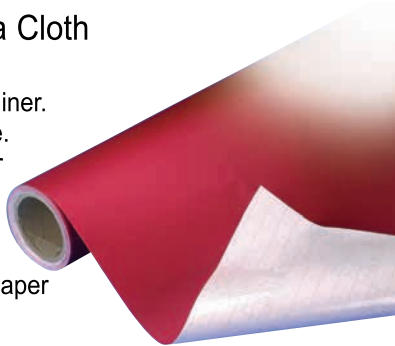

Part No.	Roll Width: mm/in	Roll Length: m/yd	Color
J514RD	1370 54	45.7 50	Red
J514OR	1370 54	45.7 50	Fluoro Orange
J514GR	1370 54	45.7 50	Green
J514BU	1370 54	45.7 50	Blue
J514BK	1370 54	45.7 50	Black
J514GY	1370 54	45.7 50	Gray
J514WT	1370 54	45.7 50	White
J514FP	1370 54	45.7 50	Hot Pink
J514YE	1370 54	45.7 50	Yellow
J514KE	1370 54	45.7 50	Kevlar

Note: Information correct at time of print. Other colors available against special order. Color representation from 4-color process and for reference purposes only. Please inquire for color

## High Tack Polyester Insignia Cloth

- ▲ Manufactured in USA.
- ▲ Available in white only.
- ▲ Aggressive glue, no grid on paper.
- ▲ Cut lengths available.

Part No.	Roll Width: mm/in	Roll Length: m/yd	Color
J530WT	1370 54	45.7 50	White

## UV Coated Polyester Insignia Cloth

- ▲ Manufactured in USA.
- ▲ Titanium Dioxide pigment coating applied for the best UV protection.
- ▲ Acrylic adhesive.
- ▲ Cut lengths available.

Part No.	Roll Width: mm/in	Roll Length: m/yd	Color
J530WTUV	1370 54	45.7 50	White

## PVC (Vinyl) Insignia Cloth

- ▲ Adhesive backed vinyl material with a semi-gloss finish for numbers, letters and graphic designs.

Part No.	Material	Tape Width: mm/in	Roll Length: m/yd	Color
J550WT	Vinyl	69 27	46 50	White

## Camber Tape/Draft Stripe

- ▲ Insignia cloth with an aggressive adhesive and release paper.
- ▲ These tapes are placed approximately parallel to the horizon on racing mainsails and genoas to make a contrasting line to help determine the components of the sail shape.
- ▲ Available only on full rolls.



Part No.	Material	Tape Width: mm/in	Roll Length: m/yd	Color
J005BK	Polyester	25 1	46 50	Black
J005BU	Polyester	25 1	46 50	Blue
J005RD	Polyester	25 1	46 50	Red
J007BK	Polyester	50 2	46 50	Black
J007BU	Polyester	50 2	46 50	Blue
J007GY	Polyester	50 2	46 50	Grey
J007RD	Polyester	50 2	46 50	Red
J009BK	Polyester	75 3	46 50	Black
J009BU	Polyester	75 3	46 50	Blue
J009RD	Polyester	75 3	46 50	Red

Note: Color representation from 4-color process is for reference purposes only. Please inquire for color sample of actual fabric.



### White Insignia Cloth for Reinforcement & Repairs

- ▲ Single side adhesive material slit to widths for seam reinforcement, quick sail repairs, and to cover seams for protection against chafe.
- ▲ Excellent for quick sail repairs.



Part No.	Material	Tape Width: mm/in		Roll Length: m/yd		Color
J071	Hi-Tack Polyester	25	1	46	50	White
J072	Hi-Tack Polyester	50	2	46	50	White
J073	Hi-Tack Polyester	75	3	46	50	White
J074	Hi-Tack Polyester	100	4	46	50	White
J076	Hi-Tack Polyester	150	6	46	50	White
J051	Polyester	25	1	46	50	White
J052	Polyester	50	2	46	50	White
J053	Polyester	75	3	46	50	White

### Hi Tack Polyester Sail Repair Tape

- ▲ Manufactured from polyester Insignia cloth with very aggressive adhesive.

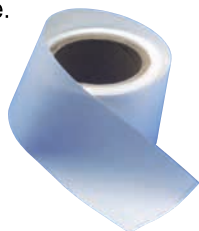

Part No.	Roll Length: m/ft		Width: mm/in	
J610WT	4.5	15	50	2
J613WT	4.5	15	75	3

### Clear Mylar Polyester Film with Adhesive

- ▲ Repair clear film products.
- ▲ Pressure sensitive adhesive.



Part No.	Width: mm/in		Roll Length: m/yd		Film
J874	1370	54	45	50	Clear
J872	50	2	45	50	Clear

### Sail RIPair® Tape - Nylon

- ▲ Available only on full rolls.



Part No.	Roll Width: mm/in		Roll Length: m/ft		Color
J601RD	50	2	7.6	25	Red
J601GD	50	2	7.6	25	Gold
J601GR	50	2	7.6	25	Green
J601BU	50	2	7.6	25	Blue
J601LB	50	2	7.6	25	Light Blue
J601BK	50	2	7.6	25	Black
J601WT	50	2	7.6	25	White
J601HP	50	2	7.6	25	Hot Pink
J601SR	50	2	7.6	25	Silver

Note: Color representation from 4-color process is for reference purposes only. Please inquire for color sample of actual fabric.

### Sail RIPair® Tape Box

- ▲ For resale of J601.
- ▲ Clear cellophane window for view of tape color within.
- ▲ Slotted hanging hole for display on pegboard or slatwall



Part No.	Description
J603	Tape Box

Insignia & Repair Tapes

## Seaming Tapes

Bainbridge International stocks many styles of double sided adhesive tapes for holding components such as panels and patches in place before sewing. The tapes offered vary in type and degree of adhesion as well as carrier and component construction.

### Acrylic Adhesives:

Generally the softer the adhesive the higher the initial tack but the weaker the long term bond. Compared with rubber based products acrylic adhesives feature lower initial tack but better long term bond.

They also do not turn yellow in UV light making them ideal for general seaming applications.

### Carriers:

Tapes are offered using either Mylar, tissue or fabric carriers. Tissue products are easier to apply as they tear easily. Mylar carriers are more stable and so do not stretch and shrink back like tissue products. Fabric carriers are recommended for lightweight film/film laminate sails where the strength of the carrier helps to prevent stitching pulling through the sailcloth.



## High Adhesion Double Sided Seaming Tape - Acrylic Based Adhesive - Polyester Carrier

- ▲ Outstanding adhesion to all types of sailcloth making this tape ideal for many seaming applications.
- ▲ Excellent initial tack with high long term adhesion.
- ▲ \*NEW: Now available in 3.5mm - 1/8" width.
- ▲ Hand tearable polyester carrier.
- ▲ UV Inhibitors.
- ▲ Non yellowing.
- ▲ Uses: Sails and Sunbrella.



Part No.	Width: mm/in	Roll Length: m/yd	Pack Qty: Rolls
*J440	3.5 1/8	55 60	144
J441	6 1/4	55 60	144
J442	9 3/8	55 60	96
J443	12 1/2	55 60	72
J444	15 5/8	55 60	64
J445	19 3/4	55 60	48
J446	25 1	55 60	48

Rubber or acrylic adhesive? Which will best meet the demands of your application?

### Rubber Adhesives

- ▲ High initial adhesion.
- ▲ Some adhesion buildup.
- ▲ Good shear strength.
- ▲ Moderate temperature resistance.
- ▲ Fair UV resistance.
- ▲ Moderate age life.

### Surface Contact:

This is fundamental to adhesive performance. To maximize contact on a substrate:

- ▲ It must be unified, dry and free of contaminants.
- ▲ Firm pressure must be applied to increase the cold flow and contact of the adhesive with the substrate.
- ▲ Time and temperature will increase the surface contact and adhesion values.

Initial contact = minimum surface adhesion  
Rubdown = more surface adhesion

### RUBBER VS. ACRYLIC ADHESIVE BOND BUILD UP

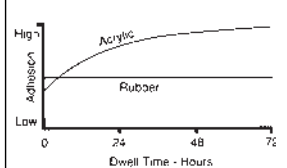

### ADHESIVE SURFACE CONTACT

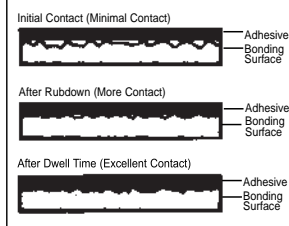

Always test the adhesive bond strength for your material and applications.

Caution!

## 3M VHB Attachment Tape

- ▲ High performance acrylic adhesive.
- ▲ Medium density white acrylic foam tape.
- ▲ Adhesive on both sides with red release liner.
- ▲ Use: Attaching automotive and marine trim, awning track, flex a rail.



Part No.	Width: mm/in	Roll Length: m/yd	Case Qty
J112V	12.7 1/2	18 20	12
J117V	22.5 7/8	18 20	12

## Economy Grade Double Sided Seaming Tape - Acrylic Based Adhesive - Tissue Carrier

- ▲ Economy grade seaming tape offering excellent value.
- ▲ Fair initial tack.
- ▲ High long term adhesion.
- ▲ Tissue Carrier.
- ▲ Non yellowing.
- ▲ Uses: Economical all purpose.



Part No.	Width: mm/in	Roll Length: m/yd	Pack Qty: Rolls
J412	9 3/8	50 54.7	180
J413	12 1/2	50 54.7	150
J415	19 3/4	50 54.7	96
J416	25 1	50 54.7	72

## Double Sided Seaming Tape - Acrylic Based Adhesive - Mylar Carrier

- ▲ High quality double sided tape for general sail seaming.
- ▲ Good initial tack.
- ▲ High long term adhesion.
- ▲ Low stretch mylar carrier.
- ▲ Non yellowing.
- ▲ Uses: Very good all purpose and ideal for patterning.



Part No.	Width: mm/in	Roll Length: m/yd	Pack Qty: Rolls
J451	6 1/4	65.8 72	144
J452	9 3/8	65.8 72	96
J453	12 1/2	65.8 72	72
J454	15 5/8	65.8 72	54
J455	19 3/4	65.8 72	48
J456	25 1	65.8 72	36

## Double Sided Rubber Based Seaming Tape

- ▲ A high tack tape used when a higher initial tack is required.
- ▲ Can turn slightly yellow.
- ▲ Carrier - polyester film.
- ▲ Uses: Very good initial tack. Can be used to stick acrylic fabrics



Part No.	Width: mm/in	Roll Length: m/yd	Pack Qty: Rolls
J351	6 1/4	66 72	144
J352	10 3/8	66 72	96
J353	12 1/2	66 72	72

## 3M Acrylic Transfer Tape

- ▲ High performance transfer tape, more elastic than conventional double sided tapes.
- ▲ Transfer tapes do not have a film or cloth carrier.
- ▲ J132 tape now available to special order - minimums may apply.
- ▲ Non-yellowing.
- ▲ Uses: Excellent for spinnakers and light sails where some stretch in the seam is desired.

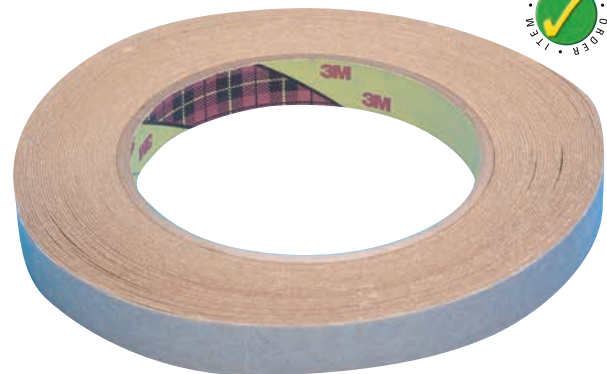

Part No.	Width: mm/in	Roll Length: m/yd	Pack Qty: Rolls
J132	10 3/8	55 60	96



**Caution!**

Always test the adhesive bond strength for your material and applications.

**Double Sided Mylar/Kevlar Seaming Tape (Temperkote) - Acrylic Based Adhesive - Fabric Carrier**

- ▲ Fair initial tack.
- ▲ High long term, non yellowing acrylic adhesive.
- ▲ Cloth Carrier.
- ▲ Uses: Designed for film/film laminate sails, cloth carrier strengthens seam and re-inforces stitching.



Part No.	Width: mm/in	Roll Length: m/yd	Material
J090	12 1/2	45.7 50	Polyester
J091	20 3/4	45.7 50	Polyester
J092	25 1	45.7 50	Polyester



**Super Tack Seaming Tape - Rubber Based Adhesive**

- ▲ Ultra high tack - soft adhesive.
- ▲ Carrier: fabric scrim.



Part No.	Width: mm/in	Roll Length: m/yd	Pack Qty: Rolls
J472	9 3/8	32.9 36	128

**Caution!**  J472 is not to be used on vinyls or vinyl window materials or when subjected to warm temperatures as adhesive can bleed.

**Tesa Tape - Orange Plastic Liner**

- ▲ A very aggressive adhesive with an orange plastic release liner.
- ▲ Excellent for sticking luff tape to the sail before sewing.
- ▲ Good for Stamoid.
- ▲ Carrier: polyester film.



Part No.	Width: mm/in	Roll Length: m/yd	Pack Qty: Rolls
J492	10 3/8	55 60	96
J493	12 1/2	55 60	72

Clear Window Materials

Please go back to pages 48-53 for full details of our range of clear window vinyls and Monofilms



Seam Roller

▲ Use for applying pressure to seams bonded with double sided adhesive tape.



Part No.	Description
C523	Seam Roller

Application of 3M Super Seam Tape

It is important that the following instructions are adhered to:



- ▲ Select width tape based on seam width and shear strength requirements.
- ▲ Use only on film surfaces of laminate sail cloths.
- ▲ Areas to be bonded must be clean and free from grease.
- ▲ Do not touch the areas to be bonded.
- ▲ Rub down or apply pressure with a roller to all seams after bonding.
- ▲ Allow the finished sail to lie flat for 24 hours before use.
- ▲ Do not use on horizontal or highly loaded seams of fore and aft sails without additional stitching.
- ▲ Do not use with silicone finished fabrics.



Caution!

Warning: Quality of bond is dependent on atmospheric conditions, dwell time and correct application.  
Always test adhesive bond strength for your material and application.



# Your Best Defense Against the Elements



Sun, salt water and wind are  
no match for Dabond<sup>®</sup> *nano*.

The bonded, twisted continuous filament  
polyester thread combines superior  
sewability with excellent UV and  
abrasion protection.

Dabond<sup>®</sup> *nano* is specifically designed to  
withstand nature's toughest elements.



BONDED OF  
POLYESTER THREAD

Dabond<sup>®</sup> *nano* thread is now available from your nearest Bainbridge distribution center.

## Dabond® Pre-Wound Bobbins with Core

- ▲ These pre-wound bobbins with a core have more thread per bobbin than can be wound-on by a sewing machine.
- ▲ There is no sticking with core bobbins which eliminate uneven thread tension.
- ▲ Saves time and effort.
- ▲ Pre-wound bobbins are supplied only in full packs of 144 bobbins.



Part No.	Dabond® Size	Type	Color
EB046DWT	V46	D	White
EB046FWT	V46	F	White
EB046GWT	V46	G	White
EB046LWT	V46	L	White
EB069DWT	V69	D	White
EB069FWT	V69	F	White
EB069GWT	V69	G	White
EB069LWT	V69	L	White
EB092DWT	V92	D	White
EB092FBK	V92	F	Black
EB092FWT	V92	F	White
EB092GBK	V92	G	Black
EB092GWT	V92	G	White
EB092HWT	V92	H	White
EB092JBK	V92	J	Black
EB092JWT	V92	J	White
EH092LWT	V92	L	White
EB092MWT	V92	M	White
EB138 39WT	V138	39	White
EB138GBK	V138	G	Black
EB138GWT	V138	G	White
EB138JWT	V138	J	White
EB138MBK	V138	M	Black
EB138MWT	V138	M	White



## Bobbin Selection Chart



Sewing Machine	Type	Diameter: mm/in		Thickness: mm/in	
Adler 67	G	21.0	0.83	11.0	0.43
Adler 98	F	25.0	0.98	7.0	0.27
Bernina 217	D	21.8	0.86	7.6	0.30
Brother 937	J	24.0	0.94	11.0	0.43
Consew 98	L	20.0	0.79	8.0	0.31
Consew 206 RBI	M	24.5	0.96	10.5	0.41
Juki LU562	G	21.0	0.83	11.0	0.43
Juki 241	M	24.5	0.96	10.5	0.41
Pfaf 138/238	L	20.0	0.79	8.0	0.3
Singer 61	D	21.8	0.86	7.6	0.30
Singer 107/143/457	F	25.0	0.98	7.0	0.27
Singer 111/112/167/211G151/212	G	21.0	0.83	11.0	0.43
Singer 212	J	24.0	0.94	11.0	0.43

### Page Navigation

### Seam Rippers

Please turn to pages 140-141 for the full range of seam rippers, snips and shears.



## Heminway & Bartlett NANO Bonded Polyester "Anti-Wick" Thread

Heminway and Bartlett "Anti-Wick" thread has been designed for outdoor applications. As well as having high strength and good UV resistance, it reduces the penetration of water through the stitching.

- ▲ Supplied on tubes of 450g/1lb nominal weight.
- ▲ "Anti-Wick" thread is ideally suited for tents/boat tops/awnings/duffel bags and other outdoor products subject to water seepage through seams.
- ▲ "Anti-Wick" combines superior sewability and a permanent anti-wick additive that blocks water migration through seams and meets MIL SPEC V-T-285 Type II.



"Z" Left or Machine Twist

Part No.	Dabond® #	Color	Canvas Size
EA069WT	V69	White	24
EA069BK	V69	Black	24
EA069PB	V69	Pacific Blue (Neptune)	24
EA092WT	V92	White	16
EA092BK	V92	Black	16
EA092BU	V92	Navigator Blue	16
EA092PB	V92	Pacific Blue (Neptune)	16
EA092GY	V92	Silver Gray	16
EA138WT	V138	White	12
EA138BK	V138	Black	12



### Caution!

It is occasionally possible for fabrics to be sewn to contain agents which encourage pigment migration from colored threads. We recommend that the following test is carried out before use.

Take a small coil of thread and place between two pieces of the chosen fabric, dampened. Place a 5kg/10lb weight on top and leave for 24 hours after which check if any pigment migration has occurred. Do NOT use if there is any doubt concerning pigment migration.

## Dabond® NANO Machine Threads

Heminway & Bartlett Dabond 2000 thread sets industry standards due to its:

- ▲ High strength and controlled stretch.
- ▲ Resistance to abrasion and salt water.
- ▲ Stability in sunlight and resistance to mildew.
- ▲ Bonding and resistance to needle heat.
- ▲ Continuous thread: no knots/breaks in thread.



## Heminway & Bartlett Dabond® NANO Thread

- ▲ Produced with carefully controlled processes and can normally be used with a variety of fabrics.
- ▲ Available in other colors against special order.
- ▲ Put up on 450g/16 ounce spools. Part numbers with an 8 at the end are normally put up on 225g/8 ounce spools.

Part No.	Dabond® Size	Color	Color Code
ET030WT	V30	White	-
ET030BK	V30	Black	50
ET046WT	V46	White	-
ET046BK	V46	Black	50
ET046BU	V46	Navigator Blue	144
ET069WT	V69	White	-
ET069BK	V69	Black	50
ET069BU	V69	Navigator Blue	144
ET069RD	V69	Cardinal Red	62
ET069GY	V69	Silver Gray	11485
ET069TN	V69	Chestnut Brown	3925
ET092WT	V92	Natural	-
ET092BK	V92	Black	50
ET092BU	V92	Navigator Blue	144
ET092GY8	V92	Silver Gray	11485
ET092TN8	V92	Chestnut Brown	3925
ET138WT	V138	White	-
ET138BK	V138	Black	50
ET138BU	V138	Navigator Blue	144
ET138TN	V138	Chestnut Brown	3925
ET207WT	V207	White	-
ET207BK	V207	Black	3925
ET346WT	V346	White	-

Thread shades listed have been formulated to offer the highest standards in color matching for the fabrics listed in the Bainbridge catalog.



Due to the manufacturing and dyeing process the thread may appear darker than on the color card. When sewn on the fabric the thread should match the color card.

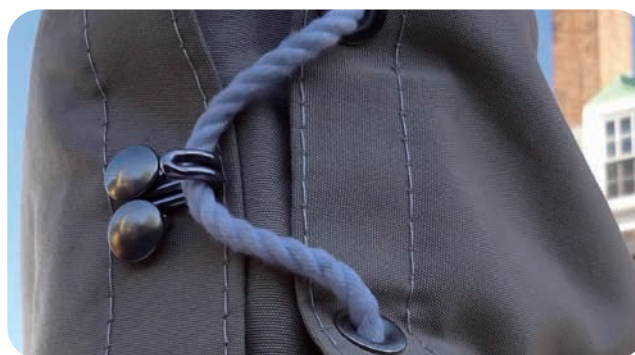



## Heminway & Bartlett Dabond® NANO Thread 1oz Spools

- ▲ Produced with carefully controlled processes and can normally be used with a variety of sailcloth.
- ▲ Available in other colors against special order.
- ▲ Now available put up on 28g/1 ounce spools.



Part No.	Dabond® Size	Color	Color Code
ET069WT1	V69	White	1oz



## Bainbridge Thread - 16oz Spools

- ▲ Quality bonded polyester thread left twist.
- ▲ Ultra-violet and mildew resistant.
- ▲ Thread is supplied on plastic tubes.
- ▲ Normal spool size is 450g/1lb



Part No.(8/16oz)	Thread Size	Color	Canvas Size
EX046WT/8	46	White - 8oz	40
EX069BK	69	Black - 16oz	24
EX069WT	69	White - 16oz	24
EX092WT	92	White - 16oz	16
EX138WT	138	White - 16oz	12

## Thread Selection Chart



Dabond® Part No.	Needle Size: Imperial/Metric		Average Yield: m/yd per lb		Average Tensile: kg/lb	
	Imperial	Metric	m/yd	yd/lb	kg/lb	lb/lb
V30	11 - 14	75 - 90	12,951	14,170	2.13	4.7
V46	12 - 15	80 - 95	7,467	8,170	3.36	7.4
V69	15 - 18	95 - 110	5,110	5,590	4.95	10.9
V92	17 - 20	105 - 125	3,866	4,230	6.58	14.5
V138	19 - 21	120 - 130	2,523	2,760	10.26	22.6
V207	21 - 23	130 - 160	1,682	1,840	14.71	32.4
V346	-	23 - 26	1,005	1,100	26.38	58.1

## Sewing Machine Needle Selection Chart

- ▲ Every single Groz-Beckert sewing machine needle is string polished with an eye matching thread and polishing compound to achieve a smooth thread protective surface.
- ▲ Many other needle system styles are available. Please consult with your representative for precise sewing machine to needle compatibility.



Thread - Metric	80	90	100	110	120	130	140	160	180	200
Thread - Singer	12	14	16	18	19	21	22	23	24	25
V-30										
V-46										
V-69										
V-92										
V-138										
V-207										
V-346										

## Sunstop Thread - 8oz



- ▲ Supplied on special eight ounce spools & sold per spool.
- ▲ Bonded Polyester.
- ▲ Anti-Wick Thread.
- ▲ Colors match most popular Sunbrella colors.
- ▲ 220g/8 ounce spools.



Black



Forest Green

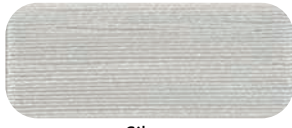

Silver



Logo Red



Cadet Grey

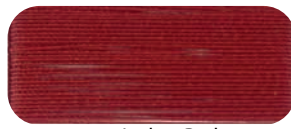

Jockey Red



Linen



Burgundy



Toast

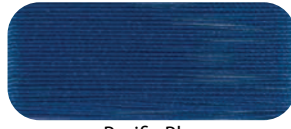

Pacific Blue



Beige



Captain Navy



True Brown



Navy

92 Part No.	138 Part No.	Color
EY092BEG8	EY138BEG8	Beige 8oz
EY092BG8	EY138BG8	Burgundy 8oz
EY092BK8	EY138BK8	Sunstop Black 8oz
EY092BRN8	EY138BRN8	Sunstop Brown 8oz
EY092CNV8	ET138CNV8	Sunstop Captain Navy 8oz
EY092FGR8	ET138FGR8	Sunstop Forest Green 8oz
EY092GY8	EY138GY8	Sunstop Grey 8oz
EY092JRD8	EY138JRD8	Sunstop Jockey Red 8oz
EY092LN8	EY138LN8	Sunstop Linen 8oz
EY092LRD8	EY138LRD8	Sunstop Logo Red 8oz
EY092NV8	EY138NV8	Sunstop Navy 8oz
EY092PB8	EY138PB8	Sunstop Pacific Blue 8oz
EY092SR8	EY138SR8	Sunstop Silver 8oz
EY092TS8	EY138TS8	Sunstop Toast 8oz
EY092WT	EY138WT8	Sunstop White 8 oz



## Bainbridge Thread - 4oz Spools

- ▲ Quality bonded polyester thread left twist.
- ▲ Ultra-violet and mildew resistant.
- ▲ Thread is supplied on plastic tubes.
- ▲ Normal spool size is 113g/4oz.



Part No. (4oz)	Thread Size	Color	Canvas Size
EX092AQ4	92	Aqua - 4oz	16
EX092BG4	92	Burgundy - 4oz	16
EX092BK4	92	Black - 4oz	16
EX092FGR4	92	Forest Green - 4oz	16
EX092GY4	92	Gray - 4oz	16
EX092LN4	92	Linen - 4oz	16
EX092NV4	92	Navy - 4oz	16
EX092OY4	92	Oyster - 4oz	16
EX092PB4	92	Pacific Blue - 4oz	16
EX092WT4	92	White - 4oz	16



## Polyester Sailtwine

▲ Easy to wax, no kink polyester hand sewing sailtwine.



Part No.	Size	Color	Pack Qty
Q381	5-ply x 227g/8oz	White	1
Q382	7-ply x 227g/8oz	White	1

## Heminway & Bartlett Pre-Waxed Hand Sewing Thread

▲ Pre waxed polyester thread supplied on spools.  
▲ Available only in white.



Part No.	Description/Thickness	Spool Weight g/lb
EW346	V-346 (.026"/.66mm)	450 1
EW462	V-462-M (.032"/.8mm)	450 1
EW499	V-9-C (.036"/.9mm)	450 1

## Whipping Twine - Colors

▲ Supplied in 8oz spools.  
▲ Thickness: .030"/.78mm  
▲ Pre waxed polyester thread



Part No.	Description
EW415BK	8oz Spool - Whipping Twine Black
EW415BU	8oz Spool - Whipping Twine Blue
EW415GLD	8oz Spool - Whipping Twine Gold
EW415GRN	8oz Spool - Whipping Twine Green
EW415RED	8oz Spool - Whipping Twine Red
EW415WT	8oz Spool - Whipping Twine White

## Waxed Polyester Sailtwine Bobbins

▲ Pre-Waxed thread equivalent to EW499 wound into bobbins.  
▲ Ideal for sail repair kits.  
▲ Sailtwine is sold in full packs only (12 bobbins per pack).



Part No.	Description/Thickness	Pack Qty
EW500	V6M (.042"/1.07mm)	12

## Waxed Nylon Lacing Tape

▲ Flat braided to lie flatter than normal.



Part No.	Description	Color	Width: mm/in	
EW351	Spool of 500yd	White	1.6	0.06
EW352	Spool of 500yd	White	3.2	0.125
EW352BK	Spool of 500yd	Black	3.2	0.125

## Sailmakers Wax

▲ Natural bees wax C040.  
▲ Composition wax supplied in bar C041.

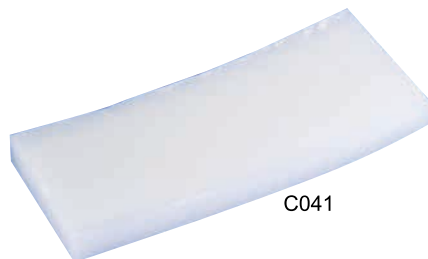

C041



C040

Part No.	Description
C040	85g/3oz Cup of Thread Wax
C041	454g/16oz Block of Thread Wax

# GUARANTEED FOR LIFE. MADE IN THE U.S.A.

© 2022 W. L. Gore & Associates, Inc.

For outdoor and marine products that won't come apart at the seams, trust GORE® TENARA® Sewing Thread

Versatile, high-performance GORE® TENARA® Sewing Thread is the perfect choice for all your award-winning — and most-demanding — marine and outdoor projects. Up your game with the original premium outdoor sewing thread that's unaffected by sunlight, and guaranteed to last a fabric's lifetime.

- Choose vibrant colors or clear thread
- Won't fade, stain, discolor or absorb water
- Stays strong and flexible in extreme heat or freeze cycles
- Resists damage from sun's UV rays, mold, mildew and saltwater
- Withstands harsh cleaning solutions, acid rain and industrial pollutants

Lifetime warranty and more at  
[gore.com/tenara](https://gore.com/tenara)



*Together, improving life*

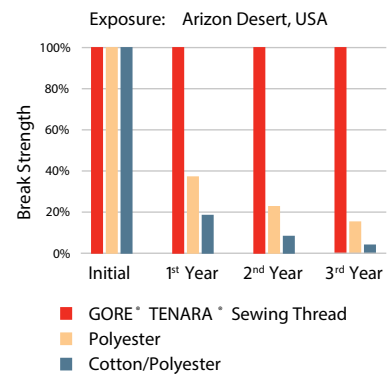

## Gore® Tenara® Sewing Threads

- ▲ Immune to UV degradation.
- ▲ Non-flammable - 550°F melting point.
- ▲ Will not rot or mildew.
- ▲ Thread is made of 100% synthetic PTFE fiber.
- ▲ Thread is not affected by acid rain, industrial pollutants, or

Lifetime warranty: *If the seams on your boat cover or other marine canvas (except sails) sewn with M1000 Tenara thread ever fail due to exposure to sunlight, weather or water we will pay for the re-seaming repair work. Please ask sales representative for a written copy of the Tenara warranty.*



## Gore® Tenara® Selection Chart



Thread	Denier/yl lb		Breaking Strength: kg/lb	
M1000KTR	1400	3900	4.0	10
M1003HTR	2500	2100	6.8 - 9.0	19

## Gore® Tenara® Heavy Duty - M1000H

- ▲ Original Tenara style thread.
- ▲ Approx. polyester equivalent is V138.
- ▲ One pound spools.



Part No.	Thread	Color	Spool Weight g/oz	
EG200HWT	Tenara M1000H-1	White	454	16
EG200HBK	Tenara M1000H-1	Black	454	16

## Gore® Tenara® M1000KTR

- ▲ Approx. polyester equivalent is V92.
- ▲ Lubricated for high speed sewing.
- ▲ Needle runs cooler.
- ▲ Guaranteed for both marine and awning applications



Part No.	Thread	Color	Spool Weight g/oz	
EG100TR	M1000 KTR-L-5	Translucent	227	8
EG100TBK	M1000 KTR-BK-5	Black	227	8
EG100TWT	M1000 KTR-WH-5	White	227	8
EGTFGR	M1000 KTR-FGR-5	Forest Green	227	8
EG100TGY	M1000 KTR-GY-5	Dark Gray	227	8
EG100TNVY	M1000 KTR-NVY-5	Navy Blue	227	8
EG100TCB	M1000 KTR-CB-5	Chesapeake Blue	227	8

## Gore® Tenara® M1003HTR

- New, improved, easy-to-sew, three ply Tenara sewing thread in a heavyweight style
- ▲ Increased yardage of thread per spool than available before.
  - ▲ Bonded by design - no additives or coatings.
  - ▲ Thread runs through the machine more smoothly.
  - ▲ Immune to the sun's UV rays.
  - ▲ Completely inert to acid rain, salt water & harsh chemicals.
  - ▲ Approx. polyester equivalent is V138.



Part No.	Thread	Color	Spool Weight g/oz	
EG103HTR	M1000 HKTR-L-5	Translucent	227	8
EG103HTBK	M1000 HKTR-BK-5	Black	227	8
EG103HTWT	M1000 HKTRWH-5	White	227	8

## YKK Zipper & Sliders - No.4.5 Coil

- ▲ Plastic coil sewn onto polyester zipper tape.
- ▲ Continuous zipper material can be cut to your required length.

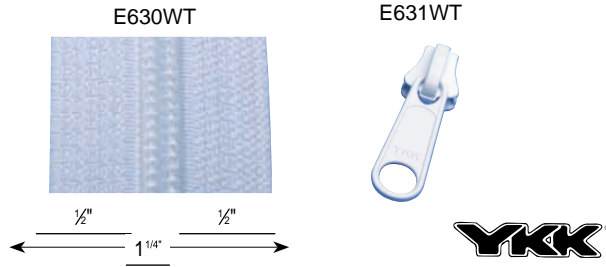

Part No.	Material	Width: mm/in	Reel Length: m/yd
E630WT	Polyester - White	32 1 1/4"	200 218
E630BK	Polyester - Black	32 1 1/4"	200 218

Part No.	Slider Type	Description	Finish	Pack Qty
E631WT	Single Metal	Locking	White	100
E631BK	Single Metal	Locking	Black	100

## YKK Zipper & Sliders - No.5 Coil

- ▲ Plastic coil sewn onto polyester zipper tape.
- ▲ Continuous zipper material can be cut to your required length.

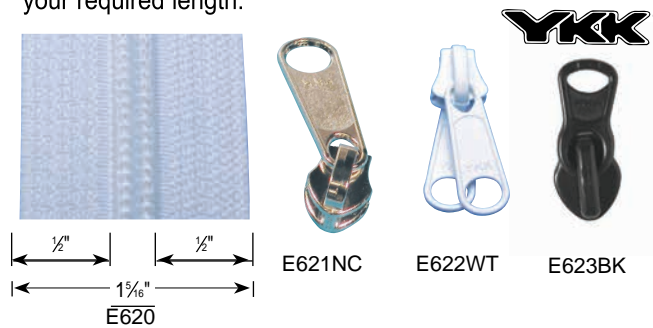

Part No.	Material	Width: mm/in	Reel Length: m/yd
E620	White Polyester	33 1 5/16"	200 218
E620BK	Black Polyester	33 1 5/16"	200 218

Part No.	Slider Type	Description	Finish	Pack Qty
E621BK	Single Metal	Non-Locking	Black	100
E621NC	Single Metal	Non-Locking	Nickel	100
E621WT	Single Metal	Non-Locking	White	100

Part No.	Slider Type	Description	Finish	Pack Qty
E622BK	Double Metal	Non-Locking	Black	100
E622WT	Double Metal	Non-Locking	White	100

Part No.	Slider Type	Description	Finish	Pack Qty
E623BK	Single Plastic	Non-Locking	Black	100
E623WT	Single Plastic	Non-Locking	White	100

Page Navigation

Zipper Pulls Tabs and Lubricants

Please turn to page 127 for the full range of these products.

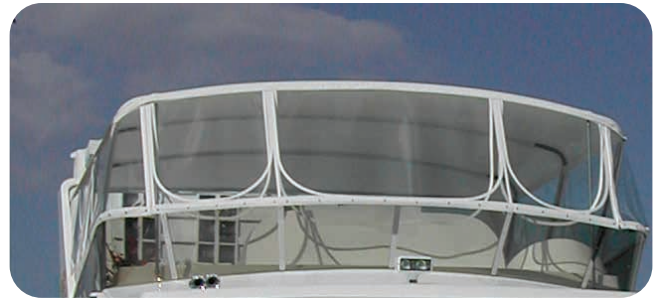

## YKK Zipper & Sliders - No.8 Coil

- ▲ Plastic coil sewn onto polyester zipper tape.
- ▲ Continuous zipper material can be cut to your required length.

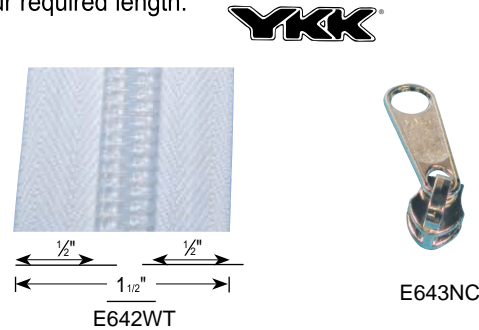

Part No.	Material	Width: mm/in	Reel Length: m/yd
E642WT	White Polyester	35 1 3/8"	150 164
E642BEG	Beige Polyester	35 1 3/8"	150 164

Part No.	Slider Type	Description	Finish	Pack Qty
E643WT	Single Metal	Non-Locking	White	100
E643BEG	Single Metal	Non-Locking	Beige	100

## YKK Zipper & Sliders - No.10 Coil

- ▲ Plastic coil sewn onto polyester zipper tape.
- ▲ Continuous zipper material can be cut to your required length.

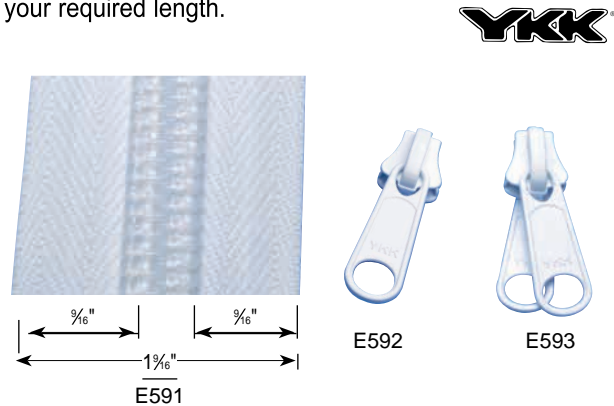

Part No.	Material	Width: mm/in	Reel Length: m/yd
E591	White Polyester	40 1 1/16"	100 109
E591BK	Black Polyester	40 1 1/16"	100 109

Part No.	Slider Type	Description	Finish	Pack Qty
E592BK	Single Metal	Non-Locking	Black Enamelled	100
E592NC	Single Metal	Non-Locking	Nickel	100
E592	Single Metal	Non-Locking	White Enamelled	100
E593NC	Double Metal	Non-Locking	Nickel	100
E593	Double Metal	Non-Locking	White Enamelled	100
E593BK	Double Metal	Non-Locking	Black Enamelled	100

YKK Zipper Sliders - No.5 Vislon



Part No.	Slider Type	Description	Finish	Pack Qty
E547	Single Metal	Non-Locking	White Enamelled	100
E547BK	Single Metal	Non-Locking	Black Enamelled	100
E548	Double Metal	Non-Locking	White Enamelled	100
E548BK	Double Metal	Non-Locking	Black Enamelled	100
E549	Single Plastic	Locking	White	100
E549BK	Single Plastic	Locking	Black	100

YKK Continuous Zipper - No.5 Vislon

- ▲ Injection molded Delrin teeth onto a 100% polyester zipper tape.
- ▲ Continuous zipper material can be cut to your required length.



E546/109  
E546BK/109

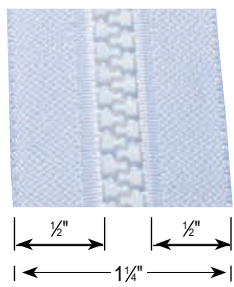

Part No.	Tape Material	Width: mm/in	Reel Length: m/yd
E546	White Polyester	31.7 1 1/4	200 218
E546BK	Black Polyester	31.7 1 1/4	200 218
E546/109	White Polyester	31.7 1 1/4	100 109
E546BK/109	Black Polyester	31.7 1 1/4	100 109

YKK Continuous Zipper & Sliders - No.8 Vislon

- ▲ Delrin teeth onto a 100% polyester zipper tape.
- ▲ Continuous zipper material can be cut to required length.

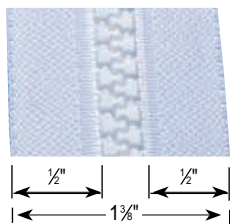

E556



E557

Part No.	Tape Material	Width: mm/in	Reel Length: m/yd
E556	White Polyester	35 1 3/8	125 136
E556BK	Black Polyester	35 1 3/8	125 136

Part No.	Slider Type	Description	Color
E557	Double Metal Slider	Non-Locking	White
E613BK	Single Metal Slider	Locking	Black
E614BK	Double Metal Slider	Locking	Black
E639WT	Single Metal Slider	Non-Locking	White

YKK Zipper Sliders - No.10 Vislon



Part No.	Slider Type	Description	Finish	Pack Qty
E545WT	Single Metal	Locking	White	100
E545BK	Single Metal	Locking	Black	100
E585	Single Metal	Non-Locking	White	100
E585BK	Single Metal	Non-Locking	Black	100
E586	Double Metal	Non-Locking	White	100
E586BK	Double Metal	Non-Locking	Black	100
E587	Single Plastic	Locking	White	100
E587BK	Single Plastic	Locking	Black	100
E594	Double Plastic	Locking	White	100
E594BK	Double Plastic	Locking	Black	100
E573	Double Metal	Locking	White	100
E573BK	Double Metal	Locking	Black	100

YKK Continuous Zipper - No.10 Vislon

- ▲ Delrin teeth onto a 100% polyester zipper tape.
- ▲ Continuous zipper material can be cut to required length.



E584/54  
E584BK/54

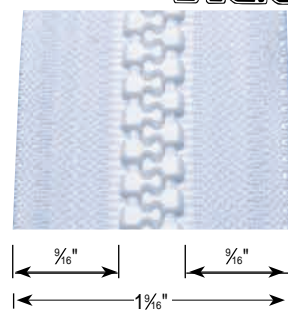

Part No.	Tape Material	Width: mm/in	Reel Length: m/yd
E584	White Polyester	39.7 1 9/16	100 109
E584BK	Black Polyester	39.7 1 9/16	100 109
E584/54	White Polyester	39.7 1 9/16	50 54
E584BK/54	Black Polyester	39.7 1 9/16	50 54

Stainless Steel Sliders - No.10

- ▲ Suitable for most No.10 molded tooth zipper material.
- ▲ Stronger than standard plastic or nickel sliders.
- ▲ Manufactured from 316 stainless steel.



Part No.	Slider Type	Description	Finish	Pack Qty
E617SS	Single Metal	Non-Locking	Stainless Steel	100
E618SS	Double Metal	Locking	Stainless Steel	100

## YKK Continuous Zipper - No.10 Beige Vislon

- ▲ Delrin teeth onto a 100% polyester zipper tape.
- ▲ Continuous zipper material can be cut to the required length.



E586BEG

E584BEG

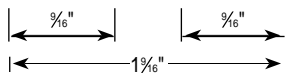

Part No.	Tape Material	Width: mm/in	Reel Length: m/yd
E584BEG	Beige Polyester	39.7 1 9/16	100 109

Part No.	Slider Type	Description	Finish	Pack Qty
E586BEG	Double Metal	Non-Locking	Beige	100



*Little Parts. Big Difference.®*

## Zipper & Sliders - No.15 Molded

- ▲ Injection molded Delrin teeth onto a 100% polyester zipper tape.
- ▲ Stronger than No.10.
- ▲ Can be used on large mainsail boom zipper bags.
- ▲ Continuous zipper material can be cut to your required length.



E635WT



E637SS



E637WT

Part No.	Tape Material	Width: mm/in	Reel Length: m/yd
E635WT	White Polyester	70 2 3/4	32 35

Part No.	Slider Type	Description	Finish
E637WT	Single w/loop - Metal	Non-Locking	White Enamelled
E637SS	Single w/loop - Metal	Non-Locking	Stainless Steel

## YKK Zipper Stops - No.10 Vislon

- ▲ Press through tape and bend tabs over.
- ▲ Designed for use with No. 10 Vislon.
- ▲ Sold in full packs only - order by the pack.
- ▲ E585TS simply snaps onto the end of the zipper.



E584TS



E584BS



E584SSTS



E585TSBK

Part No.	Description	Color	Pack Qty
E584TS	Top Stop	White - Metal	200
E584BS	Bottom Stop	White - Metal	100
E584SSTS	S.S. End Stop	Stainless Steel	200
E585TSBK	YKK Top Stop	Black - Plastic	100
E585TSWT	YKK Top Stop	White - Plastic	100

## Zipper Stop Pliers

- ▲ Top quality zipper stop setting pliers.
- ▲ Use with: E584SSTS



Part No.	Description	Use With
C352	Zipper Stop Pliers	E584SSTS





### YKK Jacket Zippers - No.5 Vislon Single Metal Locking Sliders

▲ Each zipper length is made from Delrin with a 100% polyester tape and has a molded-in box and pin starter and top stop.



Part No.	Color	Length: cm/in		Pack Qty
E595	White	122	48	50
E596	White	213	84	10
E597	White	472	186	5
E589	White	549	216	5
E598	White	671	264	5

### YKK Jacket Zippers - No.8 Vislon Double Metal Non Locking Sliders

▲ Each zipper length is made from Delrin with a 100% polyester tape and has a molded-in box and pin starter and top stop.



Part No.	Color	Length: cm/in		Pack Qty
E602	White	61	24	50
E604	White	91	36	25
E605	White	122	48	25
E606	White	137	54	20
E607	White	152	60	20
E608	White	183	72	20
E609	White	213	84	10
E610	White	244	96	10
E612WT	White	853	336	10

Part No.	Color	Length: cm/in		Pack Qty
E602BK	Black	61	24	50
E604BK	Black	91	36	25
E605BK	Black	122	48	25
E606BK	Black	137	54	20
E607BK	Black	152	60	20
E608BK	Black	183	72	20
E610BK	Black	244	96	10



### Zipper Pulls

- ▲ New and improved design for extra holding strength.
- ▲ Durable pre-assembled pull cord.
- ▲ Easy grip design works on zippers, covers, clips etc.



Part No.	Color	Pack Qty
A165BK	Black	100
A165WT	White	100

### Zippy Cool - Zipper Lube and Cleaners

- ▲ Effective "no-silicon" way to clean and lubricate all types of zipper.
- ▲ Excellent for all button fasteners.

Approved by  
**YKK**



Part No.	Description
M030	Zippy Cool Kit (M031 & M032)
M031	Zippy Cool Cleaning Fluid and Lubricant with Brush
M032	Zippy Cool Wax Lubricant

## YKK Jacket Zippers - No.10 Vislon Double Metal Locking Sliders

- ▲ Each zipper length is made from Delrin with a 100% polyester tape and has a molded-in box and pin starter and top stop.
- ▲ Available in White, Black & Beige.



E560WT

E560BK

E561BEG

Part No.	Color	Length: cm/in		Pack Qty
E559	White	45.5	18	50
E560	White	61.0	24	50
E571	White	76.2	30	25
E561	White	91.0	36	25
E562	White	106.0	42	25
E563	White	122.0	48	25
E564	White	137.0	54	20
E565	White	152.0	60	20
E566	White	168.0	66	20
E567	White	183.0	72	20
E575	White	198.0	78	20
E570	White	213.0	84	10
E572	White	244.0	96	10
E574	White	274.0	108	10
E576	White	305.0	120	10
E577	White	365.8	144	10
E578	White	457.0	180	5

Part No.	Color	Length: cm/in		Pack Qty
E560BK	Black	61.0	24	50
E571BK	Black	76.2	30	25
E561BK	Black	91.0	36	25
E563BK	Black	122.0	48	25
E564BK	Black	137.0	54	20
E565BK	Black	152.0	60	20
E567BK	Black	183.0	72	20
E575BK	Black	198.0	78	20
E570BK	Black	213.0	84	10
E572BK	Black	244.0	96	10
E576BK	Black	305.0	120	10
E577BK	Black	365.8	144	10
E578BK	Black	457.0	180	10

Part No.	Color	Length: cm/in		Pack Qty
E561BEG	Beige	91.0	36	25
E563BEG	Beige	122.0	48	25
E565BEG	Beige	152.0	60	20
E567BEG	Beige	183.0	72	20
E570BEG	Beige	213.0	84	10
E572BEG	Beige	244.0	96	10

## YKK White Jacket Zippers - No.10 Vislon Single Metal Locking Sliders

- ▲ Each zipper length is made from Delrin with a 100% polyester tape and has a molded-in box and pin starter and top stop.



E560MS



E560MSBK

Part No.	Color	Length: cm/in		Pack Qty
E560MS	White	61	24	50
E561MS	White	91	36	25
E563MS	White	122	48	25
E565MS	White	152	60	20
E567MS	White	183	72	20
E570MS	White	213	84	10
E572MS	White	244	96	10

Part No.	Color	Length: cm/in		Pack Qty
E561MSBK	Black	91	36	25
E563MSBK	Black	122	48	25
E565MSBK	Black	152	60	20
E567MSBK	Black	183	72	20
E572MSBK	Black	244	96	10

Part No.	Color	Length: cm/in		Pack Qty
E600MSBK	Black	787.3	310	10

## YKK White Jacket Zippers - No.10 Vislon Single Metal Non Locking Sliders

- ▲ Each zipper length is made from Delrin with a 100% polyester tape and has a molded-in box and pin starter and top stop.



Part No.	Color	Length: cm/in		Pack Qty
E563MSN	White	122	48	25
E572MSN	White	244	96	10



*Little Parts. Big Difference.®*

## YKK White Jacket Zippers - No.10 Vislon Double Plastic Locking Sliders

▲ Each zipper length is made from Delrin with a 100% Polyester tape and has a molded-in box and pin starter and top stop.



Part No.	Color	Length: cm/in		Pack Qty
E561DPS	White	91	36	50
E563DPS	White	122	48	25
E565DPS	White	152	60	20
E567DPS	White	183	72	20

## YKK White Jacket Zippers - No.10 Vislon Single Plastic Locking Sliders

▲ Each zipper length is made from Delrin with a 100% polyester tape and has a molded-in box and pin starter and top stop.



Part No.	Color	Length: cm/in		Pack Qty
E560PS	White	61	24	50
E561PS	White	91	36	25
E563PS	White	122	48	25
E565PS	White	152	60	20
E567PS	White	183	72	20
E570PS	White	213	84	10
E600PSWT	White	7874	310	5



Beige #10 Vislon Zippers  
Now available from  
36" to 96" lengths

## Zip Components

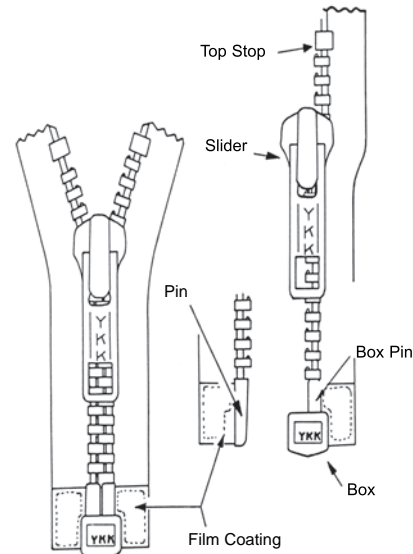

## YKK Jacket Zippers - No.10 Coil Single Metal Non Locking Sliders

▲ Plastic coil sewn onto polyester zipper tape.

▲ Each zipper length is made from coil zipper with a 100% polyester tape and has a metal nickel box and pin starter and top stop.



Part No.	Color	Length: cm/in		Pack Qty
E563C	White	122	48	25
E565C	White	152	60	20
E567C	White	183	72	20
E570C	White	213	84	10
E572C	White	244	96	10

### Page Navigation

## YKK Continuous Coil Zipper & Sliders

Please turn back to page 124 for the full range of these products.



YKK Jacket Zippers

## Nylon Velcro®

- ▲ The original Velcro brand hook and loop, all purpose fastening system.
- ▲ VELCRO Roll length: 23m/25 yards.
- ▲ VELCRO hook & loop sizes and components may be mixed to obtain a better price break.
- ▲ Colors can be supplied against special order with a minimum order of 250 yards each part.

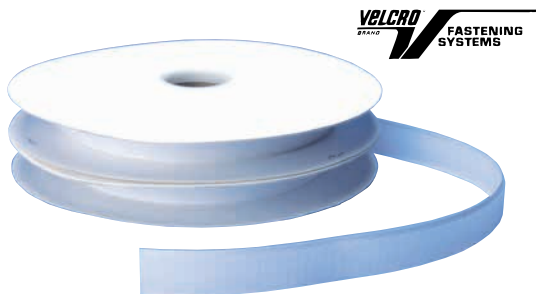

White



Black

Part No.	Width: mm/in	Type	Color
E500HWT	15 5/8	Hook	White
E500LWT	15 5/8	Loop	White
E520HWT	25 1	Hook	White
E520LWT	25 1	Loop	White
E520HBK	25 1	Hook	Black
E520LBK	25 1	Loop	Black
E530HWT	38 1 1/2	Hook	White
E530LWT	38 1 1/2	Loop	White
E540HWT	50 2	Hook	White
E540LWT	50 2	Loop	White
E540HBK	50 2	Hook	Black
E540LBK	50 2	Loop	Black

## VELSTICK® Semi Rigid

- ▲ Rigid plastic molding strips with nylon Velcro hook or loop. Attach using glue, screws, tacks or staples.
- ▲ VELSTICK is supplied in strips 122cm/48 inches in length
- ▲ Manufactured by the Velcro Company



Part No.	Width: mm/in	Type	Color
E720HBK	25 1	Hook	Black
E720LBK	25 1	Loop	Black
E720HWT	25 1	Hook	White
E720LWT	25 1	Loop	White

## Polyester Velcro®

- ▲ Polyester Velcro offers improved UV resistance. It does not absorb water like nylon hook & loop can, and exhibits less shrink than nylon.
- ▲ VELCRO Roll length: 23m/25 yards.
- ▲ VELCRO hook & loop sizes and components may be mixed to obtain a better price break.

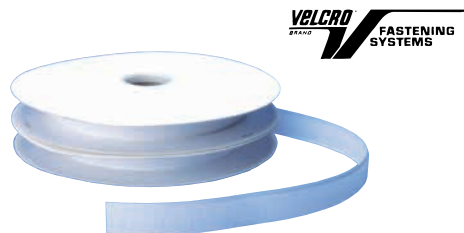

Part No.	Width: mm/in	Type	Color
E650HWT	25 1	Hook	White
E650LWT	25 1	Loop	White
E650HBK	25 1	Hook	Black
E650LBK	25 1	Loop	Black
E660HWT	38 1 1/2	Hook	White
E660LWT	38 1 1/2	Loop	White
E670HWT	50 2	Hook	White
E670LWT	50 2	Loop	White
E670HBK	50 2	Hook	Black
E670LBK	50 2	Loop	Black

## Spectrum Plus™ Adhesive Backed Polyester VELCRO®

- ▲ Polyester Velcro with a water and high temperature-resistant pressure sensitive adhesive.
- ▲ Best grade Velcro adhesive.
- ▲ VELCRO Roll length: 23m/25 yards.
- ▲ Polyester exhibits less shrink than nylon.
- ▲ VELCRO hook & loop sizes and components may be mixed to obtain a better price break.

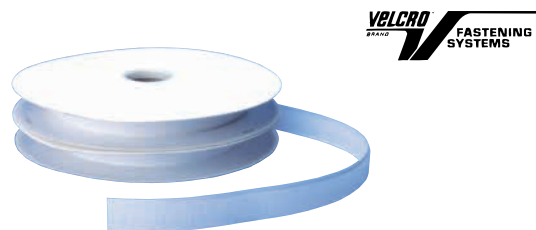

Part No.	Width: mm/in	Type	Color
E650HAWT	25 1	Hook	White
E650LAWT	25 1	Loop	White
E650HABK	25 1	Hook	Black
E650LABK	25 1	Loop	Black
E670HAWT	50 2	Hook	White
E670LAWT	50 2	Loop	White
E670HABK	50 2	Hook	Black
E670LABK	50 2	Loop	Black

### Polyester Economy Hook & Loop

- ▲ Now In 1" & 2" - Roll length is 23m/25 yards.
- ▲ Top quality but economically priced.
- ▲ Good UV Resistance

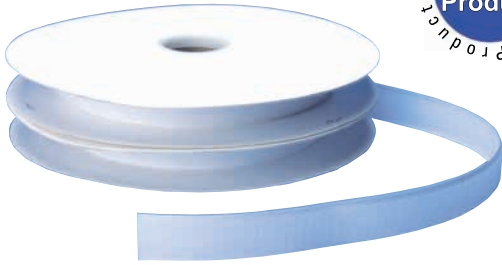

Part No.	Width: mm/in	Type	Color
E825HBK	25 1	Hook	Black
E825LBK	25 1	Loop	Black
E825HWT	25 1	Hook	White
E825LWT	25 1	Loop	White
E845HBK	50 2	Hook	Black
E845LBK	50 2	Loop	Black
E845HWT	50 2	Hook	White
E845LWT	50 2	Loop	White

### Rigid Hook Washer

- ▲ Screws or glues onto hull. Attaches to seats, cushions, velcro or loop products.
- ▲ Available only in White.
- ▲ Sold in packs of 25 pieces only.

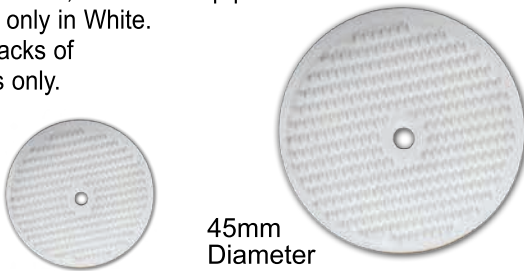

25mm Diameter

45mm Diameter

Part No.	Diameter	Color	Pack Quantity
E710WT	25 1"	White Only	25
E714WT	45 1 3/4"	White Only	25



### Pneumatic Upholstery Staple Gun

- ▲ Ergonomic handle and rubber grip.
- ▲ Bottom loading magazine aides speed of reloading.
- ▲ Two finger trigger.
- ▲ Rear exhaust with muffler.
- ▲ Applications: Marine & automotive upholstery, Bedding, Molding.



Part No.	Description
C754	Heavy Duty Empire Pneumatic Upholstery Staple Gun

### Upholstery Staples - Stainless Steel

- ▲ Specifically for the pneumatic staple gun.
- ▲ Sold in boxes of 10,000 pieces.
- ▲ Stainless Steel.
- ▲ #7 - 1/4", 3/8" & 1/2" sizes.



Part No.	Description
D744	Stainless Steel #7 Upholstery Staples 1/4"
D748	Stainless Steel #7 Upholstery Staples 3/8"
D742	Stainless Steel #7 Upholstery Staples 1/2"

### Staple Remover



Part No.	Description
C519	Metal Push-Type Staple Remover

## Sewing Machine Needle Facts:

### Needle Thread Breakage/Fraying

#### Causes:

- ▲ There are several causes of thread breakage or fraying. Usually it is the result of some interference with the needle thread.
- ▲ Any sharp edge along the path the needle thread travels can cause this failure. This includes the thread guides, needle, needle hole plate, presser foot, feed dog and looper. These areas must be free of burrs and sharp edges.
- ▲ Too tight tension can also cause thread breakage or fraying. Thread breakage could result from excessive needle heat.

#### Needle Recommendations:

- ▲ Check for correct needle size.
- ▲ Try a larger size needle.

**GROZ-BECKERT®**

### Skip Stitches

#### Basic Reason:

Inability to obtain proper formation of the needle thread loop or failure of the looper or hook to enter the thread loop at the proper time and place.

#### Some Causes:

- ▲ Timing of looper or hook is incorrect.
- ▲ Incorrect setting of the take up and pull off devices.
- ▲ Loss of thread control (too large an eye in the needle, usually resulting from needle size being too large for thread being used).
- ▲ Needle vibration or staggering.
- ▲ Incorrect hole size in throat plate.
- ▲ Needle being deflected by resistance of material (multi-ply of material, elastic inserts, etc.).
- ▲ Needle crooked or bent.

#### Hints:

- ▲ Rotate needle slightly so it throws the needle thread loop into the looper.
- ▲ Check machine setting and thread tension.
- ▲ If possible, try larger size needle

### Needle Breakage

#### Causes:

- ▲ Too small a size needle being used to perform the seaming operation.
- ▲ Incorrect needle being used in machine.
- ▲ Machine interference - looper hitting needle, feed dog timing, too small a hole in throat plate.

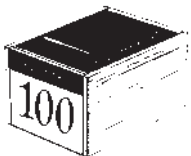

- A: Chemically polished needle eye.
- B: Groz-Beckert string polished needle eye.

**GROZ-BECKERT®**

## San 5 Gebedur Sewing Needles

- ▲ Titanium Nitride coated needles provides high protection.
- ▲ Higher needle bedding resistance.
- ▲ Reduced needle breakage.
- ▲ Improved loop formation.
- ▲ Cut diamond point.
- ▲ Longer working time.
- ▲ Use for: technical textiles, firm materials, polycarbonate films.

Part No.	Needle System Description	Size
NN43/0/120	System 135 x 17	120
NN43/0/130	System 135 x 17	130

## Sewing Machine Needle Selection Chart

- ▲ Every single Groz-Beckert sewing machine needle is string polished with an eye matching thread and polishing compound to achieve a smooth thread protective surface.
- ▲ Many other needle system styles are available. Please consult with your representative for precise sewing machine to needle compatibility.

Part No.	System	Part No.	System
Adler 67	134	Singer 107	135x7
Adler 98-2	134-5	Singer 111W100	135x7
Adler 166-1	328	Singer111W112	135x17
Adler 167	134	Singer 167	135x7
Pfaff 138, 238	134	Singer 211G151	135x7
Pfaff 145	134	Juki LU562	135x17
Pfaff 545	134	Juki LH512	135x7
Consew 272	134	Juki LU651	135x17
Consew 206RB	135x17	Bernina 217-25	278WKH

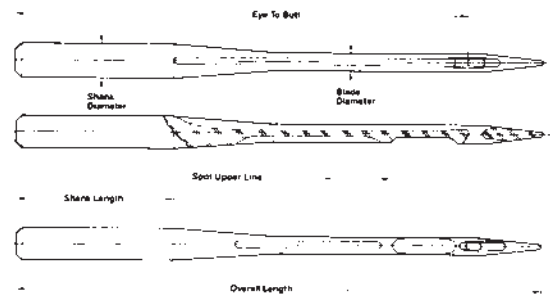

Thread - Metric	80	90	100	110	120	130	140	160	180	200
Thread - Singer	12	14	16	18	19	21	22	23	24	25
V-30										
V-46										
V-69										
V-92										
V-138										
V-207										
V-346										

## Sewing Machine Needles

Part No.	Needle System Description	Size
NN30/0/140	System 328	140
NN30/0/160	System 328	160
NN30/0/180	System 328	180
NN40/0/100	System 134, 135 x 7	100
NN40/0/110	System 134, 135 x 7	110
NN40/0/120	System 134, 135 x 7	120
NN40/0/125	System 134, 135 x 7	125
NN40/0/130	System 134, 135 x 7	130
NN42/0/110	System 135 x 17	110
NN42/0/120	System 135 x 17	120
NN42/0/125	System 135 x 17	125
NN42/0/130	System 135 x 17	130
NN42/0/140	System 135 x 17	140
NN42/0/160	System 135 x 17	160
NN44/0/110	System 134 x 35	110
NN44/0/120	System 134 x 35	120
NN44/0/130	System 134 x 35	130
NN44/0/140	System 134 x 35	140

### Thread Lubricators

- ▲ Lubricator box fixes securely to sewing machine to lubricate thread as you sew.
- ▲ Does not require removal from sewing machine for refilling.
- ▲ Magnet on base holds lubricator firmly in place.



Part No.	Description	Use With
C061	Lubricator Box with Felt Pads and Reservoir	M305

### Thread Lubricant

- ▲ M-301 - Non-toxic combination of petroleum lubricants and silicone oils. Thread is dipped for a few minutes into the lubricant for application.
- ▲ M305 - Concentrated silicone. Lubricant is applied to felt pads in lubricator boxes or placed in reservoir of C061 style lubricator.
- ▲ Use on cotton, Dacron, nylon and other synthetic thread or old thread from which the manufacturers lubricant has evaporated.



Part No.	Description	Use
M301	1 Quart (32 Ounces / 0.95 Liters)	Dipping
M305	1 Quart (32 Ounces / 0.95 Liters) Concentrated	Lubricator

### Sewing Machine Oil

- ▲ Non staining, clear "white oil" to keep sewing machines lubricated for maximum smoothness and precision sewing.



Part No.	Description
M321	1 Quart (32 Ounces / 0.95 Liters)
M322	1 Gallon (128 Ounces / 3.6 Liters)

### Oil Bottle

- ▲ Application bottle has screw-on cap to prevent accidental spills when bottle is on its side.



Part No.	Description
C063	4 Ounce Bottle with Long Pour Tube and Cap

William Smith Palms - Retail Quality



C036



C026



C023

Part No.	Description	Style	Hand
C023	Lightweight, Non Adjustable	2	Right
C024	Lightweight, Non Adjustable	3	Right
C025	Lightweight, Non Adjustable	3	Left
C026	Lightweight, Adjustable	2 1/2	Right
C027	Lightweight, Adjustable	2 1/2	Left
C036	Medium Weight	9	Right
C037	Medium Weight	9	Left

William Smith Palms - Professional Quality



C034



C032



C028



C030

Part No.	Description	Style	Hand
C028	Good Quality Seaming	11	Right
C029	Good Quality Seaming	11	Left
C030	Good Quality Roping	12	Right
C032	Super Quality Seaming	15	Right
C033	Super Quality Seaming	15	Left
C034	Super Quality Roping	16	Right

William Smith Sailmakers Needles

- ▲ William Smith's best quality "Green Label" reduced edge.
- ▲ Available only in full packs of 25.



Part No.	Size	Length: mm/in	Diameter: mm/in	Pack Qty
C010	10	89 3.504	3.25 0.128	25
C012	12	81 3.189	2.64 0.104	25
C013	13	79 3.110	2.34 0.092	25
C014	14	76 2.992	2.03 0.080	25
C015	15	72 2.835	1.83 0.072	25
C016	16	69 2.717	1.63 0.064	25
C017	17	65 2.559	1.42 0.056	25
C018	18	62 2.441	1.22 0.048	25

Assorted Size Needles

- ▲ Tubes and packs contain assorted size needles.
- ▲ C0077 packet contains five assorted straight needles and two assorted curved needles.



C021 C022



C0077

Part No.	Description
C0077	All Purpose Hand Sewing Needles

Part No.	Description
C005	5 Needles in Assorted Sizes in Packet - William Smith
C021	10 Needles in Assorted Sizes in Tube - William Smith
C022	20 Needles in Assorted Sizes in Tube - William Smith



### Pneumatic Upholstery Staple Gun

- ▲ Ergonomic handle and rubber grip.
- ▲ Bottom loading magazine aides reload speed.
- ▲ Two finger trigger.
- ▲ Rear exhaust with muffler.
- ▲ Applications: Marine & automotive upholstery, Bedding, Molding.



Part No.	Description
C754	Heavy Duty Empire Pneumatic Upholstery Staple Gun

### Upholstery Staples - Stainless Steel

- ▲ Specifically for the pneumatic staple gun.
- ▲ Sold in boxes of 10,000 pieces.
- ▲ Stainless Steel.



Part No.	Description
D744	Stainless Steel #7 Upholstery Staples 1/4"
D748	Stainless Steel #7 Upholstery Staples 3/8"
D742	Stainless Steel #7 Upholstery Staples 1/2"

### Sewing Awl and Accessories

- ▲ Awl Set comes complete with two straight needles, waxed thread and combination wrench/screwdriver.
- ▲ Ideal for sewing and repairs on leather and canvas.
- ▲ Replacement thread sold on reels of 11 1/2m/12 1/2 yards.
- ▲ Standard thread supplied is white.



Part No.	Description
C910	Awl Set
C9105	# 5 Fine Straight Needle
C9105/3	# 5 Fine Straight Needle/Pack of 3
C9106	# 6 Curved Needle
C9106/3	# 6 Curved Needle/Pack of 3
C9108	# 8 Heavy Duty Straight Needle
C9108/3	# 8 Heavy Duty Straight Needle/Pack of 3
C911BK	Black Replacement Thread
C911WT	White Replacement Thread

### Stapling Plier

- ▲ Special Stapling Plier with High Raised Clincher.
- ▲ For stapling around bolt ropes or rolled up material.



Part No.	Description
C758	Raised Clinch Staple Pliers

### Staples

- ▲ 1 Case = 100 Boxes of 5000 Staples each.

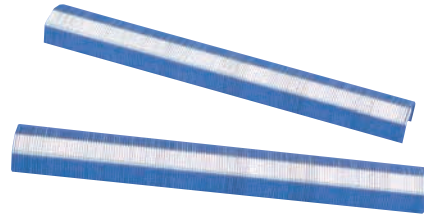

Part No.	Length: mm/in	Bostitch #	Use With
D724	6.4 1/4	STH2619	P6C, T5-6
D732	6.4 1/4	Stapling Pliers-	C758
D733	9.5 3/8	-Stapling Pliers	C758

### Staple Remover



Part No.	Description
C519	Metal Push-Type Staple Remover

### Sewing Awl



Part No.	Description
C916	Speedy Stitcher Sewing Awl
C917C8	Curved Needle #8C for Speedy Stitcher
C917ST8	Straight Needle #8S for Speedy Stitcher
C918/30	Coarse Polyester Thread - 30 Yards

## Kneepads



Part No.	Description	Pack Qty
C904	Rubber Pads with Hook & Loop Fastenings	1 Pair

## Pony Cloth Clamps



Part No.	Jaw Opening: mm/in		Overall Length: mm/in	
C515	25	1	102	4
C516	51	2	152	6
C517	76	3	229	9

## Rigger's Bag

- ▲ "Cast iron" cotton tool bag.
- ▲ 24 pockets.
- ▲ Open top, open center for large tools.
- ▲ Leather trim.
- ▲ Made from 720gsm/21oz/sq yd 100% cotton duck.



Part No.	Size: mm/in	
ZBAG7	356 L x 229 H x 191 W	14 L x 9 H x 7 1/2 W

## Sailmakers Leather

- ▲ Fuzzy leather surface both sides - E160.
- ▲ Approximate weight: 4oz/sq ft.
- ▲ Smooth surface one side/fuzzy bottom side - E163 & E164.

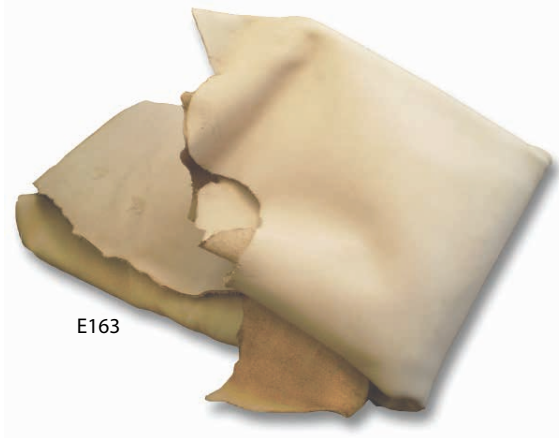

Part No.	Style	Size: m/ft	
E160	Gray Piece	0.3 x 0.6	1 x 2
E163	Tan Chrome Leather - Full Hide	About 1.9m <sup>2</sup>	About 20sq ft
E164	Pearl Gray Leather - Full Hide	About 1.9m <sup>2</sup>	About 20sq ft

## Nylon Cutting Pads

- ▲ Helps fabric cutting tools to cut a cleaner hole.
- ▲ Keeps edges sharper.

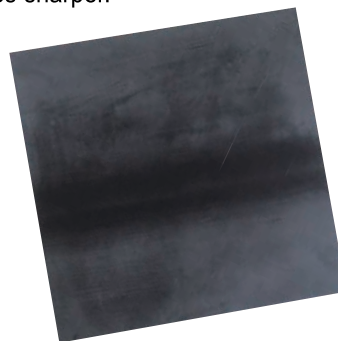

Part No.	Size: mm/in		Color
C501	250 x 250 x 13	10 x 10 x 3/8	Black



### Revolving Tube Punch

- ▲ The best revolving hole punch with 6 replaceable drive tubes ranging from 2.4 to 4.8mm/  $\frac{3}{32}$  to  $\frac{3}{16}$  inch.
- ▲ Forged handles with copper anvil.
- ▲ Industrial quality.

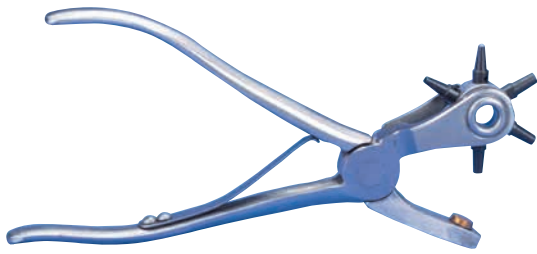

Part No.	Length: mm/in	
C350	230	9

### Replacement Tubes & Anvil for Revolving Tube Punch

- ▲ Carbon steel replacement tubes and copper anvil for C350 punch (pictured above).

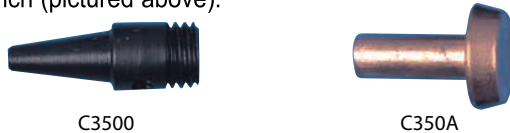

Part No.	Size: mm/in		Tube Size
C3500	1.9	$\frac{5}{64}$	0
C3501	2.4	$\frac{3}{32}$	1
C3502	2.8	$\frac{7}{64}$	2
C3503	3.2	$\frac{1}{8}$	3
C3504	4.0	$\frac{5}{32}$	4
C3505	4.4	$\frac{11}{64}$	5
C3506	4.8	$\frac{3}{16}$	6
C350A	Copper Anvil		

### Arch Hole Punches

- ▲ Manufactured to Imperial sizes.



Part No.	Size: mm/in	
C151	6.3	$\frac{1}{4}$
C152	7.9	$\frac{5}{16}$
C153	9.5	$\frac{3}{8}$
C154	11.1	$\frac{7}{16}$
C155	12.7	$\frac{1}{2}$
C156	15.9	$\frac{5}{8}$
C157	19.0	$\frac{3}{4}$
C158	22.2	$\frac{7}{8}$
C159	25.4	1
C160	28.6	$1 \frac{1}{8}$
C162	34.9	$1 \frac{3}{8}$
C163	38.1	$1 \frac{1}{2}$
C165	51.8	2

### Maul Master

This revolutionary maul is available in two sizes and offers a dramatic improvement over the old mallet or hammer style.

- ▲ Special shock absorbing, no slip rubber grip.
- ▲ Special nylon compound striking surface.
- ▲ Machined from aircraft aluminum.



Part No.	Weight: kg/lb		Length: mm/in	
C233	1.4	3.0	229	9
C234	2.0	4.5	254	10

### Rawhide Hammer

- ▲ Traditional sailmaking tool used with punches, hole cutters, grommet dies and wherever a cushioned hit is desired, now offered in a heavy weight 1.8kg/4lb, larger face style.



Part No.	Weight: kg/lb		Face Diameter: mm/in	
C530	1.2	$2 \frac{3}{4}$	45	$1 \frac{3}{4}$
C530R	Replacement Rawhide Faces for C530			
C531	1.8	4	50	2
C531R	Replacement Rawhide Faces for C531			

### Side Hole Cutters

- ▲ Manufactured to imperial sizes.



Part No.	Diameter: mm/in		Size
C180	3.2	$\frac{1}{8}$	000
C181	4.8	$\frac{3}{16}$	00A
C182	6.4	$\frac{1}{4}$	0A
C183	7.1	$\frac{9}{32}$	1A
C184	9.5	$\frac{3}{8}$	2A
C185	11.1	$\frac{7}{16}$	3A
C187	15.9	$\frac{5}{8}$	5A
C188	19.0	$\frac{3}{4}$	6A
C189	22.2	$\frac{7}{8}$	7A

## Push Pins

▲ Order quantity: 1 full pack equals 100 pins.

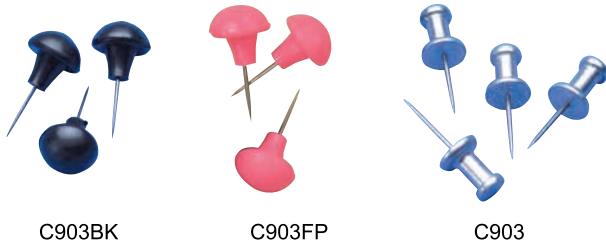

Part No.	Description	Color	Pin Length: mm/in	Pcs Per Pack
C903BK	Plastic Head	Black	14 9/16	100
C903FP	Plastic Head	Hot Pink	14 9/16	100
C903	Aluminum Head	Silver	16 5/8	100

## Awls

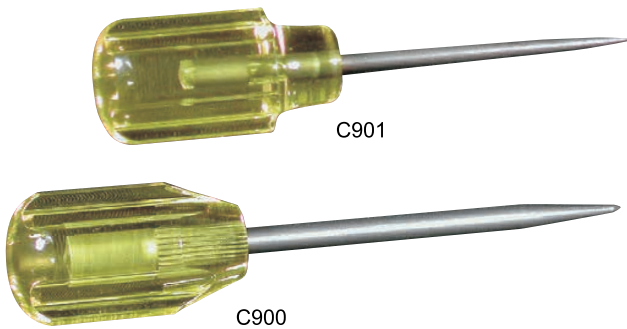

Part No.	Length: mm/in	Description	Pack Qty
C901	100 4	Yellow Handle Standard	20
C900	130 5 1/8	Yellow Handle Heavy Duty	12

## Pattern-X2 Pattern Material

- ▲ High quality semi-opaque product offering the best way to pattern a wide variety of projects.
- ▲ Manufactured from high quality polyethylene filaments coated on both sides to provide excellent tear strength and directional stability.
- ▲ FP087-144 is folded to 1830mm/72 inches, but opens to 3650mm/144 inches.

### PATTERN-X2™

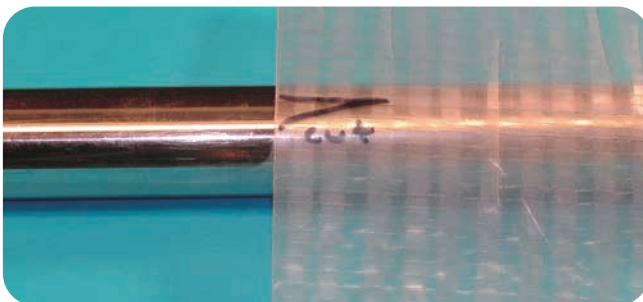

Part No.	Description	Thickness: mm/in	Roll Length: m/yd
FP085-72	1380mm/72 inch Wide	0.12 0.005	91.0 100
FP087-144	3660mm/144 inch Wide	0.12 0.005	45.5 50

## Washable Marking Pencils

Ideal for making marks on Sunbrella, Top Gun or most other fabrics and vinyls.

- ▲ Use a moist sponge or damp fabric towel to remove pencil marks.
- ▲ Pencils do not contain wax.
- ▲ Sold each or by box quantity.

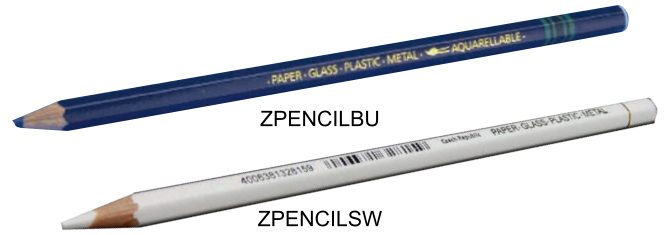

Part No.	Color	Pencils Per Box
ZPENCILSW	White	Each or 144
ZPENCILBU	Blue	Each or 144

## China Marker

Marks on boat top, industrial vinyls, glass, window vinyl, polycarbonate or any polished surface.

- ▲ String-pull sharpening.
- ▲ Wipes off easily with a damp cloth.



Part No.	Color	Pencils Per Box
ZMARKERWT	White	12



**Caution!**

▲ Note: Always test effectiveness of china markers and washable pencils on a scrap piece of the exact material before use on a new project.

## Marking-Out Chalk

- ▲ H.Hancock tailors chalk.
- ▲ Available only as a full pack.



Part No.	Color	Pack Qty
C933	White	12

### Measuring Tapes - Metal

- ▲ Impact resistant ABS case with winding handle.
- ▲ Double sided 10mm blade: meters x centimeters/ millimeters  
reverse side: feet x inches/ 1/8 inches.



Part No.	Description
C705	30m/100ft Steel Tape

### Measuring Tapes - Fiberglass

- ▲ Impact resistant case.
- ▲ C713 - Graduated top edge: feet x inches/ 1/8 inches  
bottom edge: meters x centimeters/millimeters.
- ▲ C706 - Graduated top edge: feet x inches/ 1/10 inches  
bottom edge: meters x centimeters/millimeters.



C706

C713

Part No.	Description	Scale
C713	30m/100ft/ Fiberglass	ft-in/m-mm
C706	30m/100ft/ Fiberglass	ft/1/10 ft



**Caution!**

▲ Note: Always check the position of point zero before use.

### Aluminum Rulers

- ▲ Used to make straight edge for drawing or cutting.



C710



C711

Part No.	Description	Length: m/ft		Width: mm/in	
C710	Imperial/Metric	1.00	3.28	31.2	1 1/4
C711	Imperial Only	1.83	6.00	50.8	2

### Fiberglass Lofting Battens

- ▲ Additional transport charges may be applicable.



Cross section C920/2/4

Part No.	Length: m/ft		Sections: mm/in	
C920	12.2	40	25.4 x 7.9	1 x 5/16
C922	18.3	60	25.4 x 7.9	1 x 5/16
C924	30.5	100	25.4 x 7.9	1 x 5/16

### Mylar® Pattern Material

- ▲ Available in Pale Blue or Opaque White.
- ▲ Width: 45"/1145mm or 54"/1370mm.



E062

Part No.	Style	Roll Length: m/ft		Width: mm/in		Thickness: Microns/in	
E062	Pale Blue Clear	25.0	27.3	1145	45.0	175	0.007
E063	Opaque White	47.5	50.0	1370	54.0	190	0.0075

## Knife Edge Shears

▲ One blade is ground to a knife edge for cutting synthetic fiber.

**Wiss**



Part No.	Wiss #	Length: mm/in	
C550-10	1225 Polished	254	10
C550-12	1226 Polished	305	12

## Industrial Shears

▲ Nickel plated blades.

**Wiss**



Part No.	Wiss #	Length: mm/in	
C551-7	27	178	7
C551-8	28	203	8
C551-9	29	229	9

## Heavy Duty Shears

▲ Polished blades.

**Wiss**



Part No.	Wiss #	Length: mm/in	
C552-10	20	254	10
C552-12	22	305	12
C552L-10	20 Left Hand	254	10

## Extra Heavy Duty Shears

▲ Polished blades with fully contoured handles.

**Wiss**



Part No.	Wiss #	Length: mm/in	
C555-10	20W	254	10
C555-12	22W	305	12

## Stainless Steel Shears

- ▲ Premium stainless steel, light weight scissors with knife edge. Matte black polypropylene handles prevent slips.
- ▲ Adjustable pivot assembly protected by "red button".
- ▲ Will not rust on the boat or in a sail repair kit.
- ▲ Light weight.



Part No.	Length: mm/in	
C560-9	229	9

## Soft Handle Ambidextrous Shears

- ▲ Cushion soft handles with micro serrated blade offer maximum control.
- ▲ Ergonomic design for hours of cutting comfort.
- ▲ Works with right or left hand.



Part No.	Length: mm/in	
C560-8	203	8

## 10" Stainless Steel Serrated Scissors

- ▲ Professional grade serrated edge scissors.
- ▲ Soft, comfortable grip handles.
- ▲ Cuts: Kevlar, Spectra, Dyneema etc..
- ▲ Ice tempered stainless steel.
- ▲ Serrated blades for precise cutting.
- ▲ Made In Germany.



Part No.	Length: mm/in	
C565	250	10

Page Navigation

Hot Knives and Tools  
Please turn to pages 142 & 143  
for the full range of hot knives,  
blades and accessories



### Top Snapper

This incredible hand held tool takes the effort out of attaching covers!

- ▲ Makes it easy to fasten/unfasten boat covers.
- ▲ Top Snapper reduces the risk of tearing canvas.
- ▲ Two blades will work on nearly all button snaps.
- ▲ Ergonomic handle grip design.
- ▲ Stainless steel for long life.



C525

Part No.	Description	Works with:
C525	Top Snapper	G140/G142



### Cable Cutters

- ▲ Precision Cutters by Felco (Swiss Made).
- ▲ Designed to cut wire rope.

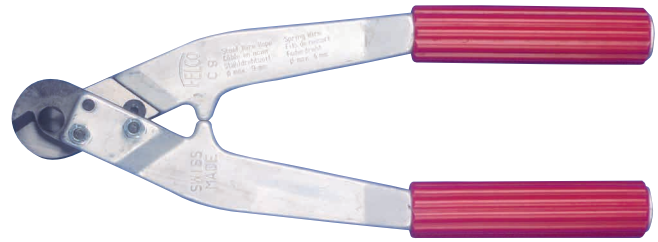

C971



C970

Part No.	Type	Max Cable: mm/in	Cutter Length: mm/in
C970	C-7	5 3/16	190 7 1/2
C971	C-9	6 1/4	320 12 1/2

### Thread Snips

- ▲ C554 Plastic with replaceable stainless steel blades.
- ▲ C553 Self-opening spring action snips

Wiss



C554

C553

Part No.	Description
C554	Professional Quality Thread Snips
C553	Self Opening Spring 121mm/4 3/4 in

### Seam Rippers

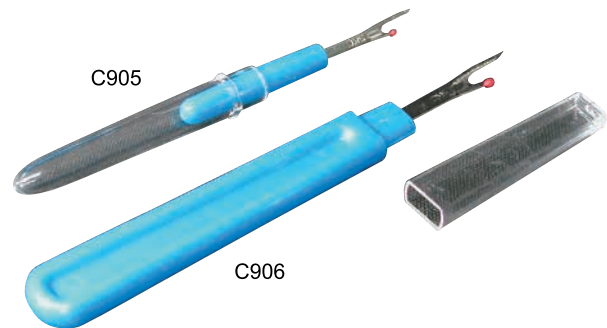

C905

C906

Part No.	Description
C905	Small for Spinnaker Seams
C906	Deluxe Quality

## Engel Hot Knife

- ▲ Designed to cut and seal synthetics, woven and knit fabrics, and cut and weld rope, cord and webbing.
- ▲ Quick heating with built in spot lights.
- ▲ Combine with optional blades for a variety of uses.
- ▲ Engel hot knife is sold without blades - see below for order details.
- ▲ Offered in two voltage styles for North American or worldwide use.



Part No.	Description	Overall Length: mm/in	Heats To	Volt	Watt
C851	HSGO - US	254 10	1000°F	110	70
C850	HSGO - Euro	254 10	1000°F	220	60



**Caution!**

Engel Hot Knife is designed for intermittent operation and should not be used for more than 20 minutes at one time without a pause.

## Engel Cutting Attachments

- ▲ Combine blades with trigger action handle to operate.
- ▲ C852 - Use with C854 or C856 cutting foot.
- ▲ C853 - Excellent for applique work, cut and seal synthetics.
- ▲ C854 - Holds material down while cutting. Use C852 blade.  
NOTE: Does not require special cutting surface.
- ▲ C856 - Use the C852 blade.  
NOTE: Does not require special cutting surface.

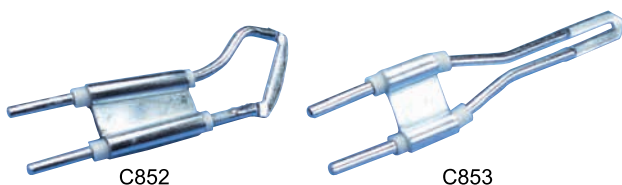

Part No.	Description	Ref
C852	Standard Blade	100R
C853	Precision Blade	HSO
C854	Adjustable Base Cutting Foot	SF

## Ultratorch Heat Tool

- ▲ Industrial strength portable gas heat tool & soldering tip.
- ▲ Becomes rugged and transportable hot knife with hot knife replacement tip (C882).
- ▲ Faster and easier to use than all other gas hot knives.
- ▲ Self-igniting with adjustable power levels.
- ▲ Standard tip is a 2.0 mil soldering tip.
- ▲ Operates for approximately 3 hours at number 3 setting.

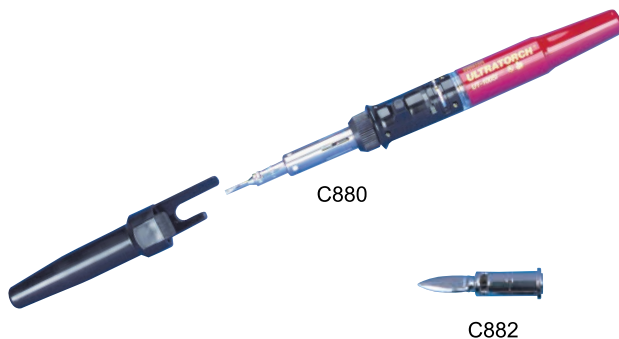

Part No.	Overall Length: mm/in	Weight: oz	Heats to
C880	267 10 1/2	5.5	950°F
C882	Hot Knife Tip	(not included with tool)	



**Caution!**

With all hot knife elements and tips, it is important not to drop tool as it will have similar results to a light bulb element breaking.

## Bench Mount Hot Knife

- ▲ Base is flanged with mounting holes for permanent placement, which allows two hands to be free for better control when cutting.
- ▲ Unit comes with base and one 2 inch cutting blade.
- ▲ Great for quick, clean cuts of rope or webbing.

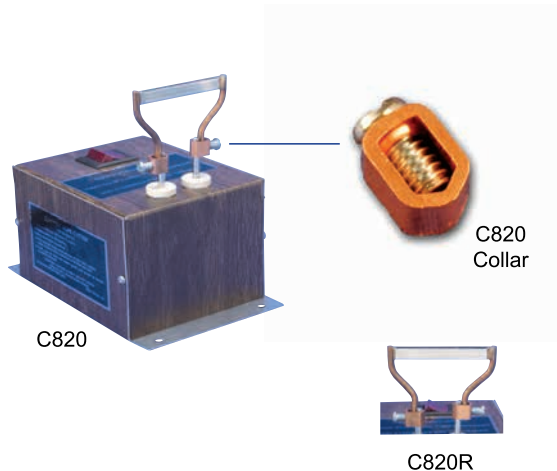

Part No.	Volt	Heats to
C820	110	1200°
C820R	2 inch Replacement Cutting Blade for C820	
C820 Collar	Replacement Locking Collar for C820	



### Ungar Hot Knife Handle and Holder

- ▲ Easy to hold power source handle to be used with either the basting tip or cutting tips below.
- ▲ Store the tool in the holder to act as a safety guard against accidents.
- ▲ Combine with tips below to produce hot knife or fusing tool.

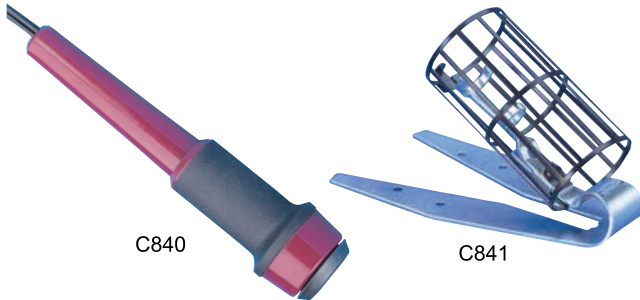

Part No.	Description	Handle Length: mm/in	Overall Length: mm/in	Heats To	Volt	Watt
C840	Handle	140 5 1/2	210 8 1/4	850°	110	18
C841	Tool Holder					

### Ungar Tips

- ▲ Combine tips with handle to produce hot knife or fusing tool as required.
- ▲ C842 - Copper cutting tip is not replaceable.
- ▲ C843 - Add to C844 hot cutting tip to make a complete hot knife.



Part No.	Description	Watt
C843	37 Heating Element Only	50
C844	100 Cutting Tip Only	

### Heat Control Unit

- ▲ Precision dial temperature controller. Unit can also extend life of hot knife tip.
- ▲ Use with either C840, C860 or C861 to lower the operating temperature of the tip.



Part No.	Description
C806	Heat Control Unit

### Hot Tool Hot Knife

The Hot Tool hot knife was recently introduced to the Bainbridge International line of cutting and sealing equipment. This light weight, easy to hold tool has a heating element which slides inside the selected tip attachment allowing a very efficient use of heat. Tips may be interchanged for cutting, sealing or circle cuts.

- ▲ Easy to hold tools with hot knife blade included.
- ▲ Heats quickly up to working temperature.
- ▲ Heat element of tool fits inside tip for greater efficiency.
- ▲ No warranty.

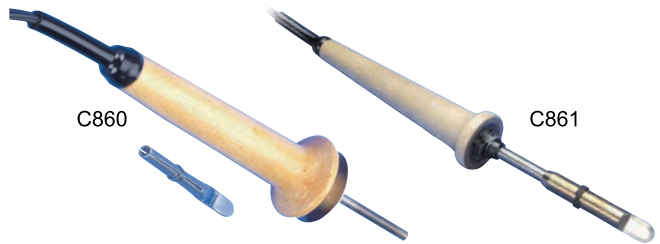

Part No.	Description	Handle Length: mm/in	Overall Length: mm/in	Heats To	Volt	Watt
C860	Light Duty	89 3 1/2	152 6	850°F	110	18
C861	Heavy Duty	127 5	241 9 1/2	1050°F	110	18

### HOT TOOL Blades & Circle Cutters

- ▲ C862/865 - Replacement tips slide over heat element of C860 and C861 for heat efficiency.
- ▲ C864/866 - Circle cutters are great for putting a heat sealed round hole in webbings and fabrics.



Part No.	Description	Scale
C862	Knife Blade for C860	
C865	Knife Blade for C861	
C864	Circle Cutter for C860	4.8 3/16
C866	Circle Cutter for C861	6.3 1/4



## "303" Ultra-Violet Protection

- ▲ 303 is excellent for preventative maintenance, with a UV screen that reduces fading and degradation due to ozone, acid rain and weather.
- ▲ Non-hazardous and biodegradable. No petrochemicals.
- ▲ Not oily or greasy - will not attract dust.
- ▲ Use on rubber, plastic, fiberglass, plexiglass, vinyl, leather, canvas and woven polyester fabrics.
- ▲ Application: Spray on. Wipe dry. Apply once or twice a year. Apply more often where UV exposure is extreme and constant. 236ml/8floc covers approx. 13m<sup>2</sup>/140 sq ft.



M010



M012



Special Shipping



M009

Part No.	Description	Liquid Measure: ml/floc		Case Qty
M009	Pump Spray	59	2	24
M010	Trigger Spray	296	10	12
M012	Gallon Refill	3780	128	4

## "303" High Tech Fabric Guard

303 High Tech Fabric Guard is powerful enough to protect fabrics in the harshest environments outdoors. Yet 303 High Tech Fabric Guard is safe for the finest fabrics, wool, silk and fine leathers.

- ▲ Superior performance, coverage and durability
- ▲ Soil and stain resistance, to store and maintain water repellence on outdoor fabrics and UV screening.
- ▲ Protects against both water and oil based stains. Treated fabrics take longer to soil and clean-up more easily. Offers 500square feet per gallon coverage.



M013



M016



Special Shipping

Recommended for



Part No.	Description	Liquid Measure: ml/floc		Case Qty
M013	Pump Spray	473	16	12
M016	Gallon Refill	3780	128	4

# KEEP THE THINGS YOU LOVE LOOKING NEWER, LONGER.

1

### Clean thoroughly with 303® Multi-Surface Cleaner.

- Tough enough for serious outdoor stains, but safe enough for the most delicate surfaces.



2

### Protect surfaces against fading and cracking with 303® Protectant.

- Superior UV protection for plastic, resin, composite wood, vinyl and more.
- Repels dust, soiling and stains with no greasy residue.



3

### Guard fabrics from stains and mildew with 303® Fabric Guard.

- Restores water-repellency to factory new levels.

The only treatment recommended by Sunbrella®



www.303products.com



WE'VE GOT YOUR NUMBER™



### “303” Fabric Cleaner

- ▲ Non hazardous – NO caustic chemicals or solvents.
- ▲ Meets or exceeds EPA standards for biodegradability.
- ▲ Safe for all water-safe materials.
- ▲ Rinses residue free.
- ▲ Powerful for heavy degreasing.
- ▲ Can be used at full strength or recommended dilution.



Part No.	Description	Liquid Measure: ml/floz		Case Qty
M020	Trigger Spray	946	32	8
M021	Gallon Refill	3780	128	4

### Mildew Remover

- ▲ Removes mold, mildew, tough dirt and some stains
- ▲ Use on fabrics, vinyl, plastic, fiberglass, wood & Sunbrella.
- ▲ Color and fabric safe.
- ▲ Gentle to skin. No harmful vapours.
- ▲ Just add water to the bio degradable non toxic, non chlorine powder.
- ▲ 1 x 340g/12 ounce jar makes 11 litres/3 gallons and offers 150 square feet of coverage.



Part No.	Description	Weight: gm/oz	
M212	Mildew Remover	340	12

Page Navigation

Seam Sealers & Water Repellents  
Please turn to page 147 for the  
full range of sealers, protectants  
and lubricants.



### IMAR Stamoid Vinyl Protection

- ▲ M0601 Vinyl Protective Cream: Improves UV and static resistance, helps retain suppleness and luster. Use every 2-3 months.
- ▲ M0602 Vinyl Protective Spray: Cleans, shines and protects Stamoid and other marine vinyls. Assists in inhibiting UV degradation and age induced brittleness.
- ▲ M0603 Vinyl Cleaner: Specially formulated to gently clean Stamoid and most other marine vinyls. Does not harm Strataglass or other clear vinyls when used in accordance with instructions.



Part No.	Description	Liquid Measure: ml/floz		Case Qty
M0601/16	Cream - Bottle	473	16	12
M0602/16	Pump Spray	473	16	12
M0603/16	Pump Spray	473	16	12
M0603/128	Gallon Refill	3785	128	4

### IMAR Yacht Soap

- ▲ Formulated to create a highly polished appearance.
- ▲ Non-streaking, non-spotting.
- ▲ Rinses clear and decreases drying time.



Part No.	Description	Liquid Measure: ml/floz		Case Qty
M224/16	Bottle	473	16	12
M224/128	Gallon Refill	3785	128	4

### 210 Cleaner & Polish

- ▲ Easy removal of all kinds of marks.
- ▲ Provides anti-static/anti-fog coating.
- ▲ Can be used on polycarbonate, acrylic, fiberglass, formica, PVC and others.



Part No.	Description	Liquid Measure: ml/floz		Case Qty
M210/7	210 Cleaner	207	7	12
M210/14	210 Cleaner	414	14	12
M211/15	210 Scratch Remover/Polish	443	15	12



### Novus Plastic Polish

- ▲ Novus system cleans, shines and protects.
- ▲ Novus 1 gently cleans plastic without scratching. Leaves shine that resists fogging, repels dust and eliminates static. Contains no abrasives.
- ▲ Novus 2 removes fine scratches and haziness, helps restore faded and discolored plastics.
- ▲ Novus 3 Removes heavy scratches and abrasion from most acrylic surfaces. Use when damage is too severe for No. 2 polish.



Part No.	Description	Liquid Measure: ml/floz		Case Qty
M170KIT	Novus#1 & #2 & Polish Mates	59	2	12
M174KIT	Novus#1 & #2 & Polish Mates	59	2	12
M171	Novus#1	59	2	12
M181	Novus#1	236	8	12
M172	Novus#2	59	2	12
M182	Novus#2	236	8	12
M173	Novus#3	59	2	12
M183	Novus#3	236	8	12
M180	Polish Mates Cloth (10 pack)	-	-	12

### Aquatech - Cleaner & Protectant

- ▲ Protects and cleans clear vinyl and polycarbonate.
- ▲ Does not contain ammonia or alcohol.
- ▲ Cleans, shines and protects clear vinyl while leaving a water repellent finish.



Part No.	Description	Liquid Measure: ml/floz		Case Qty
M185	Cleaner & Protectant	473	16	12

### IMAR Strataglass Protective Cleaner

- ▲ Uniquely formulated to clean and shine and protect Strataglass & Crystal Clear 20/20.
- ▲ Special UV inhibitors extend the useful life of Strataglass by minimizing the deteriorating effects of sunlight.
- ▲ Safe for use daily and recommended to use often.



Part No.	Description	Liquid Measure: ml/floz		Case Qty
M221/4	Pump Spray	118	4	24
M221/16	Pump Spray	473	16	12
M221/128	Gallon	3785	128	4

### IMAR Strataglass Protective Polish

- ▲ Formulated to safely clean, polish and protect Strataglass and Crystal Clear 20/20.
- ▲ Creates a nearly invincible protective barrier against the damaging effects of marine environment pollutants.
- ▲ Recommended for use every 2 - 3 months.
- ▲ Frequent use of Imar Strataglass Protective Cleaner between polishing will increase protection.



Part No.	Description	Liquid Measure: ml/floz		Case Qty
M222/4	Bottle	118	4	24
M222/16	Bottle	473	16	12

### IOSSO™ – Seam Sealer

- ▲ Protects sewn seams.
- ▲ Does not change the look or feel of the fabric.
- ▲ 118ml/4froz per bottle.



M216

Part No.	Description	Liquid Measure: ml/froz		Case Qty
M216	Bottle	118	4	12

### Aqua-Tite® Green - Water Repellent

- ▲ Premium grade water repellent - provides stain protection.
- ▲ Available in quart pump spray and gallon refill.
- ▲ Very low VOC level, meeting all known regulations.
- ▲ Can be applied by spray/mist, brush, or roller.
- ▲ Best applied in warm weather settings.



M047



M048

Part No.	Description	Liquid Measure: ml/froz		Case Qty
M047	Quart Pump Spray	946	32	12
M048	Gallon Refill	3785	128	6

### Seam Kote™ 4

Water borne urethane coating with excellent durability, flexibility and washability.

- ▲ Lightfast and UV resistant.
- ▲ Soft, flexible clear film upon drying.
- ▲ Abrasion and impact resistant.
- ▲ Does not prevent mold or mildew.
- ▲ Good adhesion to a variety of substrates.
- ▲ No aromatic solvents.
- ▲ Fast drying & very easy to clean.



Part No.	Description	Liquid Measure: l/gal		Case Qty
M150	Seam Kote 4	3.8	1	4
M151	Seam Kote 4	18.5	5	1

### Saillkote™ McLube

High performance dry lubricant.

- ▲ Clean & Dry: Saillkote is a translucent liquid that sprays or wipes on and completely dries in seconds.
- ▲ No oils, silicones or waxes - does not attract dirt.
- ▲ Long lasting: bonds to any clean and dry surface.
- ▲ Easy to apply: spray, wipe or brush. Spray on a thin, even coating, apply thin second coat to ensure coverage.
- ▲ Mask areas you do not want coated.
- ▲ Saillkote is extremely slippery.



Part No.	Description	Liquid Measure: ml/froz		Case Qty
M401	Spray	177	6	12
M402	Spray	473	16	12

### Teflon® Lubricating Spray

- ▲ Use for lubricating dies, closing tools and generally around the loft.
- ▲ Synthetic lubricant that outperforms and outlasts petroleum based lubricants.
- ▲ Reduces friction and wear.
- ▲ Prevents rust and corrosion.
- ▲ Contains no CFC's or chlorinated solvents.



Part No.	Liquid Measure
M005	312ml/11 Fl oz



## Vinyl Adhesive

- ▲ HH-66 vinyl cement is easy to apply, fast drying and a versatile adhesive for vinyl, plastic, metal, wood & leather.
- ▲ Permanently bonds all vinyls.
- ▲ Waterproof - repairs fabric leaks, used as a seam sealer.
- ▲ Dries in minutes and remains flexible.



Part No.	Description	Liquid Measure: ml/floz	Case Qty
J969	Can with Brush Top	236 8	12
J970	Can with Brush Top	472 16	-
J971	Can with Brush Top	946 32	-
J972	Gallon Refill Can	3785 128	-

## 3M VHB Attachment Tape

- ▲ High performance acrylic adhesive.
- ▲ Medium density foam tape.
- ▲ Adhesive on both sides with red release liner.
- ▲ Use: Attaching automotive and marine trim, awning track, flex a rail.



Part No.	Width: mm/in	Roll Length: m/yd	Case Qty
J112V	12.7 1/2	18 20	12
J117V	22.5 7/8	18 20	12

## Clear Mylar Polyester Film with Adhesive

- ▲ Repair clear film products.
- ▲ Pressure sensitive adhesive.



Part No.	Width: mm/in	Roll Length: m/yd	Film
J874	1370 54	45 50	Clear
J872	50 2	45 50	Clear

## 3M Brand Low VOC Adhesive Remover

- ▲ Low VOC (*Volatile Organic Compounds*) Meets CARB/OTC requirements.
- ▲ Extended dwell time.
- ▲ No Residual Film.
- ▲ For dissolving, degreasing and removing adhesives.
- ▲ For most general industrial applications.
- ▲ Available in all 50 states.
- ▲ Replaces M040 product in: CA, CT, MA, MD, ME, NH, NY, RI, VA, VT.



Part No.	Description	Liquid Measure: ml/floz	Case Qty
M041LVOC	Aerosol	710 24	12

## Adhesive Remover

A specially blended solvent that provides easy cleanup of most types of adhesive and quickly removes waxes, road tars, grease, oil and similar materials. Will not harm vinyl or fabrics when properly used. Always try on a small area of similar material before use on a sail or cover.

- ▲ Easy to apply.
- ▲ Non-Toxic.
- ▲ Non-Allergenic.
- ▲ Cannot be sold in some states.
- ▲ Much safer than acetone
- ▲ Restricted shipping to some states.



Part No.	Liquid Measure: m/oz
M040	909 32



### 3M Brand Super 77 Spray Adhesive

- ▲ Very high bond strength.
- ▲ An extremely versatile spray adhesive that permits either a temporary or permanent bond with a new "low mist" formula.
- ▲ Aggressive tack for bonding most light weight materials.
- ▲ Best on two surfaces.
- ▲ Bonding range: 15 minutes one surface/30 minutes two surfaces.
- ▲ Coverage: 20.4m<sup>2</sup>/220 square feet.
- ▲ Clear adhesive with fine mist.
- ▲ No CFC's. Ideal for headliners.



Part No.	Description	Liquid Measure: ml/floz		Case Qty
J707	Aerosol	710	24	12

### 3M Brand Super 74 Foam Adhesive

- ▲ Specially formulated spray adhesive for binding flexible urethane or latex foam together or to most other materials like wood, metal and plastics.
- ▲ Fast tack.
- ▲ Non-misting, precise spray control.
- ▲ Variable width spray provides one to three inches wide spray pattern.
- ▲ Excellent for cushion & upholstery work.



Part No.	Description	Liquid Measure: ml/floz		Case Qty
J701	Aerosol	710	24	12

### 3M General Trim Adhesive

- ▲ High strength clear adhesive.
- ▲ Non-misting – lace like spray.
- ▲ Adjustable nozzle (1 – 4 inch spray width).
- ▲ Non staining, low soak-in on foams and fabrics.
- ▲ Good heat and weather resistance.
- ▲ Bonding range: 1 to 15 minutes.
- ▲ Use on carpeting, foams, fabrics, plastics, plastics and rubber.



Part No.	Description	Liquid Measure: ml/floz		Case Qty
J979	Aerosol	710	24	12

### 3M Brand Low VOC Super 77 Spray Adhesive

- ▲ Multipurpose clear spray adhesive.
- ▲ Low VOC (*Volatile Organic Compounds*) Meets CARB/OTC requirements.
- ▲ High initial grab and aggressive tack for bonding most light weight materials.
- ▲ Bonds quickly in 15 seconds for fast, permanent results.
- ▲ Great mist spray pattern and low soak-in for high coverage.
- ▲ Clear adhesive with fine mist.



Part No.	Description	Liquid Measure: ml/floz		Case Qty
J959LVOC	Aerosol	710	24	12



Caution!

Warning: Always test adhesive bond strength for your material and application.

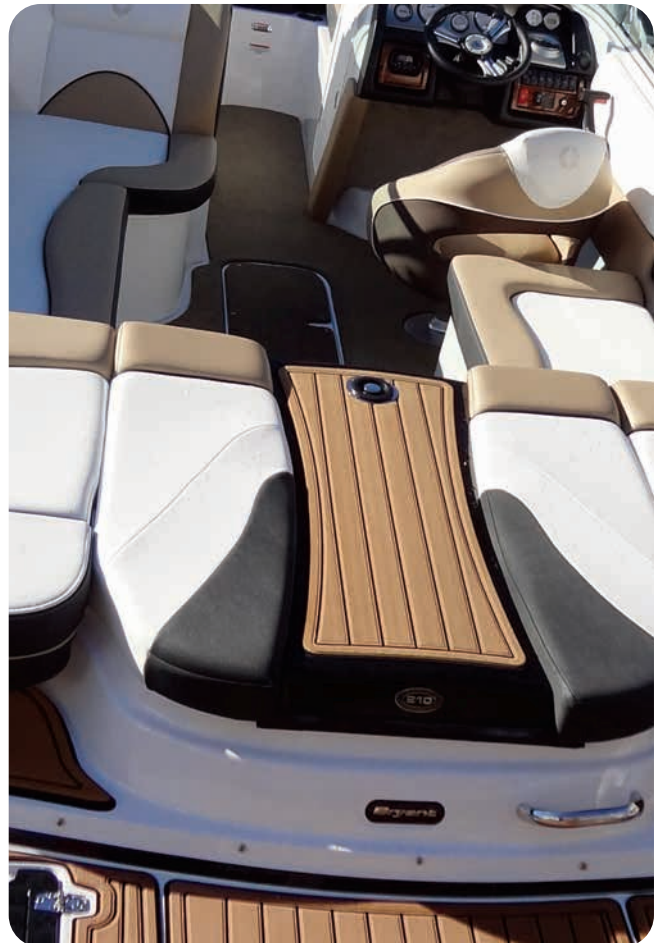

## Grey Barrel Bags

- ▲ Made from genuine Bainbridge woven sailcloth.
- ▲ Durable and splashproof.
- ▲ Reinforced handles.
- ▲ Grab handle on the end (medium only).
- ▲ Red, Blue or Black insignia sail numbers.



Part No.	Size: mm/in	
BMZ1001	500 L x 250 D	20 L x 10 D
BMZ1002	600 L x 300 D	24 L x 12 D
BMZ1003	700 L x 370 D	28 L x 15 D

## White Barrel Bags

- ▲ Made from genuine Bainbridge woven sailcloth.
- ▲ Durable and splashproof.
- ▲ Reinforced handles.
- ▲ Grab handle on the end (medium only).
- ▲ Red, Blue or Black insignia sail numbers.



Part No.	Size: mm/in	
BMZ1101	500 L x 250 D	20 L x 10 D
BMZ1102	600 L x 300 D	24 L x 12 D
BMZ1103	700 L x 370 D	28 L x 15 D

## White Deluxe Holdalls

- ▲ Made from genuine Bainbridge woven sailcloth.
- ▲ Durable and splashproof.
- ▲ Large top opening for convenience.
- ▲ Reinforced handles.
- ▲ Grab handle on the end.
- ▲ Red, Blue or Black insignia sail numbers.
- ▲ Internal and external pockets.



Part No.	Size: mm/in	
BMZ1201	500 L x 250 H x 250 W	20 L x 10 H x 10 W
BMZ1202	600 L x 300 H x 300 W	24 L x 12 H x 12 H
BMZ1203	700 L x 370 H x 370 W	28 L x 15 H x 15 W





### Washbag - Small

- ▲ Made from Bainbridge Ocean woven sailcloth.
- ▲ Splashproof.
- ▲ Exterior zipped pocket.
- ▲ Red, Blue or Black original insignia sail numbers.
- ▲ Unisex.



Part No.	Size: mm/in	
BMZ2001	210 L x 140 H x 70 W	8 L x 6 H x 3 W

### Washbag - Large

- ▲ Made from Bainbridge Ocean woven sailcloth.
- ▲ Splashproof.
- ▲ Exterior zipped pocket.
- ▲ Red, Blue or Black insignia sail numbers.
- ▲ Unisex.



Part No.	Size: mm/in	
BMZ2002	260 L x 180 H x 160 W	10 L x 7 H x 6 W

### Tote Bag

- ▲ Made from genuine Bainbridge woven sailcloth.
- ▲ Durable and splashproof.
- ▲ Large top opening for convenience.
- ▲ Soft rope handles for comfort.
- ▲ Magnetic clasp closing.
- ▲ Red, Blue or Black original insignia sail numbers.
- ▲ Internal zipped pockets.



Part No.	Size: mm/in	
BMZ2003	400 L x 300 H x 100 W	16 L x 12 H x 4 W

### Diax Sailcloth Barrel Bag & Holdall

- ▲ Made from Bainbridge Diax sailcloth.
- ▲ Red, Blue or Black insignia sail numbers.
- ▲ Exterior zipped pocket.
- ▲ Unisex.
- ▲ Splashproof.



Part No.	Size: mm/in	
BMZ1263	600 L x 300 H x 300 W	24 L x 12 H x 12 H
BMZ1052	700 L x 370 D	28 L x 15 D

Part No.	Page	Part No.	Page	Part No.	Page	Part No.	Page
A064	93	B156	96	BMZ1001	150	C301	76
A068BK/WT	87, 95	B158	96	BMZ1002	150	C302	76
A069BK/WT	87, 95	B164	101	BMZ1003	150	C303S	99
A071	87	B165	101	BMZ1052	151	C304S	99
A072BK	104	B169	102	BMZ1101	150	C305S	99
A074	105	B170	100	BMZ1102	150	C306S	99
A075	105	B171	100	BMZ1103	150	C307S	99
A076	105	B172	100	BMZ1201	150	C308S	99
A076HD	105	B173	100	BMZ1202	150	C309S	99
A077HD	105	B174	100, 102	BMZ1203	150	C327	71
A078WT	104	B174B	100	BMZ1263	151	C335	65
A079BK	104	B175	100	BMZ2001	151	C336	65
A080BK	93	B191	102	BMZ2002	151	C350	137
A083BK	93	B196	102	BMZ2003	151	C352	126
A088BK	105	B197	102	C005	134	C3500	137
A089BK/WT	105	B198	102	C0077	134	C3501	137
A090BK	86	B204	102	C010	134	C3502	137
A091WT	64	B214	100	C012	134	C3503	137
A095BK	106	B218B	101	C013	134	C3504	137
A097BK	106	B219	100	C014	134	C3505	137
A098BK	105	B220	100	C015	134	C3506	137
A099BK	105	B221	100	C016	134	C350A	137
A101	95	B221B	101	C017	134	C360	73
A102	95	B223	100	C018	134	C361	73
A103BK	95	B224	100	C021	134	C361BKW	73
A105	94	B225	100	C022	134	C361GYW	73
A106BK	94	B225B	101	C023	134	C361SPCL	73
A122BK	105	B226B	101	C024	134	C362	73
A124BK	105	B227	100	C025	134	C363	73
A125BK	105	B228	100	C026	134	C366	73, 97
A130BK	104	B229	100	C027	134	C367	73, 97
A131BK	104	B229B	101	C028	134	C368	73
A132BK	104	B248	101	C029	134	C369	73
A134BK	104	B250	101	C030	134	C370	73
A135BK	104	B401S	87	C032	134	C371	73
A140	95	B449	95	C033	134	C374	73
A141	95	B450	95	C034	134	C376	73
A141BK	104	B451	95	C036	134	C378	73
A142BK	105	B452	95	C037	134	C449	94
A145BK	94	B453	95	C040	121	C501	136
A147BK	94	B461	95	C041	121	C515	136
A152BK	105	B462	95	C061	133	C516	136
A153BK	105	B463	95	C063	133	C517	136
A159BK	105	B464	95	C140	74	C519	35, 135
A165BK/WT	127	B541N	74	C151	137	C523	115
A170	96	B542N	74	C152	137	C525	141
A172	96	B543N	74	C153	137	C530	137
B087	104	B544N	74	C154	137	C530R	137
B117	100	B545N	74	C155	137	C531	137
B118	100	B546N	74	C156	137	C531R	137
B119	100	B556	96	C157	137	C550-10	140
B120	100	B610	103	C158	137	C550-12	140
B121	100	B610S	103	C159	137	C551-7	140
B122	101	B611	103	C160	137	C551-8	140
B123	101	B611N	103	C162	137	C551-9	140
B124	101	B611SW	103	C163	137	C552-10	140
B125	101	B611SSW	103	C165	137	C552-12	140
B126	101	B612	103	C180	137	C552L-10	140
B127	100	B612S	103	C181	137	C553	141
B127B	100	B613SW	103	C182	137	C554	141
B133	96	B615	103	C183	137	C555-10	140
B134	96	B617S	103	C184	137	C555-12	140
B135	96	B632	103	C185	137	C560-8	140
B136	96	B637	103	C186	137	C560-9	140
B137	96	B650	102	C187	137	C565	140
B138	96	B651	102	C188	137	C602S	98
B153	96	B651S	102	C189	137	C603S	98
B154	96	B652	102	C233	137	C604S	98
B155	96	B7446	102	C234	137	C605S	98

Part No.	Page	Part No.	Page	Part No.	Page	Part No.	Page
C606S	98	C932A	72	D373	65	E091NV	19
C607S	98	C932B	72	D603B	98	E091RB	19
C620	72	C933	138	D603N	98	E091TST	19
C631	97	C933A	72	D604B	98	E092BG	19
C632	97	C933B	72	D604N	98	E092BK	19
C633	97	C934A	72	D605B	98	E092BU	19
C705	139	C934B	72	D605N	98	E092CNV	19
C706	89, 139	C938	72,74	D606B	98	E092FGR	19
C710	139	C939	44	D606N	98	E092GY	19
C711	139	C941A	72	D607N	98	E092LN	19
C713	89, 113	C941B	72	D724	135	E092MARBU	19
C754	35, 135	C942A	72	D732	135	E092NV	19
C758	135	C942B	72	D733	135	E092RB	19
C806	143	C944A	72	D742	35, 135	E092TST	19
C820	142	C944B	72	D744	35, 135	E093BK	19
C820COLLAR	142	C950	71	D748	35, 135	E093FG	19
C820R	142	C951	71	E062	139	E093WT	19
C831	116	C952	71	E063	139	E094BG	19
C834	116	C953	71	E075BK/WT	20	E094BK	19
C840	143	C954	43	E078	53	E094BRN	19
C841	143	C955	43	E080	53	E094CNV	19
C843	143	C956	43	E083BK	20	E094FG	19
C844	143	C957DRL	71	E083CR	20	E094GY	19
C850	142	C957HAND	71	E083IV	20	E094LN	19
C851	142	C959	71	E083NV	20	E094NV	19
C852	142	C970	141	E083RB	20	E094RD	19
C853	142	C971	141	E083SD	20	E094TC	19
C854	142	C972	115	E083SW	20	E094TST	19
C856	142	C973	115	E083WT	20	E094WT	19
C860	143	C995	84	E084BK	20	E095BG	18
C861	143	C997	84	E084CR	20	E095BI	18
C862	143	C998	84	E084IV	20	E095BK	18
C864	143	C998-14	84	E084NV	20	E095BU	18
C865	143	CL-253AN	93	E084RB	20	E095CNV	18
C866	143	CL261	93	E084SW	20	E095FGR	18
C880	142	CL262	93	E084WT	20	E095GY	18
C882	142	CL-826-11AN	93	E085BK	20	E095LN	18
C896	69	CL-827-03	93	E085CR	20	E095NV	18
C896CAP	69	D001BH	98	E085GY	20	E095OYS	18
C896KIT	69	D002BH	98	E085IV	20	E095RD	18
C897	69	D002NH	98	E085NV	20	E095TPE	18
C899	85	D003BS	99	E085RB	20	E095TST	18
C900	138	D003NS	99	E085SD	20	E095WT	18
C901	138	D004BS	99	E085SW	20	E097BG	17
C903	138	D004NS	99	E085WT	20	E097BI	17
C903BK	138	D005BS	99	E086BK	20	E097BK	17
C903FP	138	D005NS	99	E086CR	20	E097BR	17
C904	136	D006BS	99	E086IV	20	E097BU	17
C905	141	D006NS	99	E086NV	20	E097CCGY	17
C906	141	D007BS	99	E086SD	20	E097CON	17
C910	135	D007NS	99	E086SW	20	E097CNV	17
C9105	135	D008BS	99	E086WT	20	E097FGR	17
C9105/3	135	D008NS	99	E088	53	E097GY	17
C9106	135	D009BS	99	E089BK	20	E097HB	17
C9106/3	135	D009NS	99	E089CR	20	E097HTWD	17
C9108	135	D050N	86	E089NV	20	E097LN	17
C9108/3	135	D101B	97	E089SW	20	E097MARBU	17
C911BK	135	D102B	97	E089WT	20	E097MBU	17
C911WT	135	D111N	97	E090BK	18	E097MTD	17
C916	135	D112N	97	E090BU	18	E097NV	17
C917C8	135	D112SS	97	E090WT	18	E097OBU	17
C917ST8	135	D113N	97	E091BK	19	E097OY	17
C918/30	135	D350	65	E091BU	19	E097PAR	17
C920	139	D351	65	E091CNV	19	E097PSGR	17
C922	139	D352	65	E091FGR	19	E097RB	17
C924	139	D353	65	E091GY	19	E097RD	17
C930	72	D355	65	E091LN	19	E097SKY	17
C931A	72	D371	65	E091MARBU	19	E097SR	17
C931B	72	D372	65	E091MBU	19	E097TP	17

# Index By Part Number

Index By Part Number

Part No.	Page	Part No.	Page	Part No.	Page	Part No.	Page
E097TQ	17	E124NBK	107	E540LBK	130	E574	128
E097TST	17	E124NBU	107	E540LWT	130	E576	128
E097TSTWD	17	E124NRD	107	E546	125	E576BK	128
E097TUBR	17	E124NYE	107	E546/109	125	E578	128
E097WBR	17	E126BK	108	E546BK	125	E578BK	128
E097WT	17	E126BU	108	E546BK/109	125	E584	125
E098AQ	17	E126GR	108	E547	125	E584/54	125
E098ARB	17	E126GY	108	E547BK	125	E584BEG	126
E098BAS	17	E126NV	108	E548	125	E584BK	125
E098BG	17	E126RD	108	E548BK	125	E584BK/54	125
E098BI	17	E126WT	108	E549	125	E584BS	126
E098BK	17	E126YE	108	E549BK	125	E584SSTS	126
E098BR	17	E128BK	109	E556	125	E584TS	126
E098BU	17	E128WT	109	E556BK	125	E585	125
E098CAP	17	E129HD	106	E557	125	E585BK	125
E098CCGY	17	E130	109	E559	128	E585TSBK	126
E098CNV	17	E132WT	108	E560	128	E585TSWT	126
E098CON	17	E135SP	106	E560BK	128	E586	125
E098DTD	17	E136RB	106	E560MS	128	E586BK	125
E098ERGR	17	E136WT	106	E560PS	128	E586BEG	126
E098FGR	17	E139SP	106	E561	128	E587	125
E098GY	17	E143BK	108	E561BEG	128	E587BK	125
E098HB	17	E143WT	108	E561BK	128	E589	127
E098HTWD	17	E144BK	108	E561DPS	129	E591	124
E098LN	17	E144WT	108	E561MS	128	E591BK	124
E098LRD	17	E160	136	E561MSBK	128	E592	124
E098LT	17	E163	136	E561PS	129	E592BK	124
E098MARBU	17	E164	136	E562	128	E592NC	124
E098MBU	17	E307	92	E563	128	E593	124
E098MTD	17	E308	92	E563BEG	128	E593BK	124
E098NV	17	E309	92	E563BK	128	E593NC	124
E098OBU	17	E320	92	E563C	129	E594	125
E098OY	17	E321	92	E563DPS	129	E594BK	125
E098PAR	17	E322	92	E563MS	128	E595	127
E098PSGR	17	E323	92	E563MSBK	128	E596	127
E098RB	17	E324	92	E563MSN	128	E597	127
E098RD	17	E325	92	E563PS	129	E598	127
E098SB	17	E330	92	E564	128	E600PSWT	129
E098SGR	17	E331	92	E564BK	128	E602	127
E098SKBU	17	E332	92	E565	128	E602BK	127
E098SPA	17	E334	92	E565BEG	128	E604	127
E098SR	17	E335	92	E565BK	128	E604BK	127
E098TBR	17	E350P	92	E565C	129	E605	127
E098TCT	17	E350PBK	92	E565DPS	129	E605BK	127
E098TP	17	E352P	92	E565MS	128	E606	127
E09TQ	17	E352PBK	92	E565MSBK	128	E606BK	127
E098TST	17	E354P	92	E565PS	129	E607	127
E098TSTWD	17	E354PBK	92	E566	128	E607BK	127
E098WHT	17	E356P	92	E567	128	E608	127
E098WT	17	E357P	92	E567BEG	128	E608BK	127
E101	107	E358	92	E567BK	128	E610	127
E110N	109	E373	94	E567C	129	E612WT	127
E110NBK	109	E373BK	94	E567DPS	129	E613BK	125
E111N	109	E375	94	E567MS	128	E614BK	125
E112KEV	106	E376	94	E567MSBK	128	E617SS	125
E112N	109	E378	94	E567PS	129	E618SS	125
E112NBK	109	E380	94	E570	128	E620	124
E113	107	E390	35	E570BEG	128	E620BK	124
E113N	109	E494	64	E570BK	128	E621BK	124
E114N	109	E500HWT	130	E570C	129	E621NC	124
E114NBK	109	E500LWT	130	E570MS	128	E621WT	124
E115	107	E520HBK	130	E570PS	129	E622BK	124
E115BK	107	E520HWT	130	E572	128	E622WT	124
E116	107	E520LBK	130	E572BEG	128	E623BK	124
E121BK	107	E520LWT	130	E572C	129	E623WT	124
E121WT	107	E530HWT	130	E572BK	128	E630WT	124
E122	107	E530LWT	130	E572MS	128	E630BK	124
E123	107	E540HBK	130	E572MSBK	128	E631WT	124
E124	107	E540HWT	130	E572MSN	128	E631BK	124

Part No.	Page	Part No.	Page	Part No.	Page	Part No.	Page
E635WT	126	EB138GWT	117	EY092BEG8	17, 120	F0350A62Y	59
E637SS	126	EB138JWT	117	EY092BG8	17, 120	F0350A71Y	59
E637WT	126	EB138MBK	117	EY092BK8	17, 120	F0350A75Y	59
E639WT	125	EB138MWT	117	EY092BRN8	17, 120	F0350A79Y	59
E642WT	124	EG100TBK	123	EY092CNV8	17, 120	F0350A97Y	59
E642BEG	124	EG100TR	123	EY092FGR8	17, 120	F0400A07Y	15
E643BEG	124	EG100TWT	123	EY092GY8	17, 120	F0400A09Y	15
E643NC	124	EG103HTR	123	EY092JRD8	17, 120	F0400A10Y	15
E650HABK	130	EG103HTBK	123	EY092LN8	17, 120	F0400A17Y	15
E650HAWT	130	EG103HTWT	123	EY092LRD8	17, 120	F0400A18Y	15
E650HBK	130	EG200HBK	123	EY092NV8	17, 120	F0400A22Y	15
E650HWT	130	EG200HWT	123	EY092PB8	17, 120	F0400A28Y	15
E650LABK	130	ES125** Range	94	EY092SR8	17, 120	F0400A33Y	15
E650LAWT	130	ES187** Range	94	EY092TS8	17, 120	F0400A37Y	15
E650LBK	130	ES250** Range	94	EY092WT8	17, 120	F0400A42Y	15
E650LWT	130	ES312** Range	94	EY138BEG8	17, 120	F0400A44Y	15
E660HWT	130	ES375** Range	94	EY138BG8	17, 120	F0400A75Y	15
E660LWT	130	ET030BK	118	EY138BK8	17, 120	F0400A79Y	15
E670HABK	130	ET030WT	118	EY138BRN8	17, 120	F0400A82Y	15
E670HAWT	130	ET046BK	118	EY138CNV8	17, 120	F0400A96Y	15
E670HBK	130	ET046BU	118	EY138FGR8	17, 120	F0400A97Y	15
E670HWT	130	ET046WT	118	EY138GY8	17, 120	F0400A98Y	15
E670LABK	130	ET069BK	118	EY138JRD8	17, 120	F0400A99Y	15
E670LAWT	130	ET069BU	118	EY138LN8	17, 120	F0400A00Y	29
E670LBK	130	ET069GY	118	EY138LRD8	17, 120	F0550A14Y	29
E670LWT	130	ET069RD	118	EY138NV8	17, 120	F0550A18Y	29
E714WT	35, 131	ET069TN	118	EY138PB8	17, 120	F0550A22Y	29
E720HBK	130	ET069WT	118	EY138SR8	17, 120	F0550A47Y	29
E720HWT	130	ET069WT1	119	EY138TS8	17, 120	F0550A60Y	29
E720LBK	130	ET092BK	118	EY138WT8	17, 120	F0550A62Y	29
E720LWT	130	ET092BU	118	F0200A00Y	32	F0550A65Y	29
E825HBK	131	ET092GY8	118	F0200A10Y	32	F0550A66Y	29
E825LBK	131	ET092TN8	118	F0200A18Y	32	F0550A67Y	29
E825HWT	131	ET092WT	118	F0200A22Y	32	F0550A75Y	29
E825LWT	131	ET138BK	118	F0200A23Y	32	F0550A79Y	29
E845HBK	131	ET138BU	118	F0200A46Y	32	F0550A97Y	29
E845LBK	131	ET138TN	118	F0200A60Y	32	F0550A98Y	29
E845HWT	131	ET138WT	118	F0200A65Y	32	F06344181	14
E845LWT	131	ET207BK	118	F0200A67Y	32	F06344271	14
EA069BK	118	ET207WT	118	F0200A75Y	32	F06344573	14
EA069PB	118	ET346WT	94	F0200A97Y	32	F06344581	14
EA069WT	118	EW346	121	F0200A98Y	32	F06344586	14
EA092BK	118	EW351	121	F0250A97Y	27	F06344587	14
EA092BU	118	EW352	121	F0300A00Y	28	F06344683	14
EA092GY	118	EW352BK	121	F0300A10Y	28	F06344763	14
EA092PB	118	EW415BK	121	F0300A14Y	28	F06344781	14
EA092WT	118	EW415BU	121	F0300A18Y	28	F06344783	14
EA138BK	118	EW415GLD	121	F0300A22Y	28	F06344883	14
EA138WT	118	EW415GRN	121	F0300A44Y	28	F06344971	14
EB046DWT	117	EW415RED	121	F0300A46Y	28	F0700A00Y	33
EB046FWT	117	EW415WT	121	F0300A60Y	28	F0700A18Y	33
EB046GWT	117	EW462	121	F0300A65Y	28	F0700A23Y	33
EB046LWT	117	EW499	121	F0300A66Y	28	F0700A46Y	33
EB069DWT	117	EW500	121	F0300A67Y	28	F0700A60Y	33
EB069FWT	117	EX046WT/8	119	F0300A68Y	28	F0700A65Y	33
EB069GWT	117	EX069BK	119	F0300A74Y	28	F0700A66Y	33
EB069LWT	117	EX069WT	119	F0300A75Y	28	F0700A67Y	33
EB092DWT	117	EX092WT	119	F0300A79Y	28	F0700A77Y	33
EB092FBK	117	EX138WT	119	F0300A85Y	28	F0700A97Y	33
EB092FWT	117	EX092AQ4	120	F0300A89Y	28	F0700A98Y	33
EB092GBK	117	EX092BG4	120	F0300A90Y	28	F0800A00Y	30
EB092GWT	117	EX092BK4	120	F0300A97Y	28	F0800A10Y	30
EB092HWT	117	EX092FGR4	120	F0300A98Y	28	F0800A14Y	30
EB092JBK	117	EX092GY4	120	F0308A60W	28	F0800A18Y	30
EB092JWT	117	EX092LN4	120	F0350A00Y	59	F0800A20Y	30
EB092LWT	117	EX092NV4	120	F0350A13Y	59	F0800A41Y	30
EB092MWT	117	EX092OY4	120	F0350A35Y	59	F0800A44Y	30
EB138WT	117	EX092PB4	120	F0350A47Y	59	F0800A46Y	30
EB138GBK	117	EX092WT	120	F0350A60Y	59	F0800A60Y	30

# Index By Part Number

# Index By Part Number

Part No.	Page	Part No.	Page	Part No.	Page	Part No.	Page
F0800A62Y	30	F0963C048	38	FH160WT	40	FH286GY	25
F0800A65Y	30	F0963C058	38	FH162WTFR	45	FH286SBG	25
F0800A66Y	30	F0963C078	38	FH174BG	58	FH286WT	25
F0800A75Y	30	F0965A008	39	FH174BK	58	FH287BK	25
F0800A79Y	30	F0965C008	39	FH174BU	58	FH352BI	46
F0800A85Y	30	F0985A*** Range	40	FH174DRD	58	FH352DSD	46
F0800A88Y	30	F0999A*** Range	40	FH174FGR	58	FH352DGR	46
F0800A90Y	30	F35/** Range	91	FH174LN	58	FH354AL	46
F0800A97Y	30	F50/** Range	91	FH174WT	58	FH354BK	46
F0805A00Y	31	F5240D00W	43	FH180BK	22	FH354GR	46
F0805A14Y	31	F5240D08W	43	FH180CR	22	FH354GY	46
F0805A18Y	31	F5240D10W	43	FH180GY	22	FH354NV	46
F0805A44Y	31	F5240D22W	43	FH180IV	22	FH354RB	46
F0805A46Y	31	F5240D47W	43	FH180RB	22	FH354WT	46
F0805A60Y	31	F5240D60W	43	FH180SD	22	FH354YE	46
F0805A65Y	31	F5240D79W	43	FH180SW	22	FH355BEG12	47
F0805A75Y	31	F5300D00W	43	FH180WT	22	FH355BEG72	47
F0805A79Y	31	F5300D08W	43	FH182BK	25	FH355BK72	47
F0805A88Y	31	F5300D22W	43	FH182IV	25	FH355BK12	47
F0805A97Y	31	F5300D35W	43	FH182SW	25	FH355BRN72	47
F0808Z00Y	31	F5300D46W	43	FH182WT	25	FH355DSD72	47
F0808Z18Y	31	F5300D47W	43	FH184NV	24	FH355GY72	47
F0808Z79Y	31	F5300D60W	43	FH184PGY	24	FH355WT72	47
F0808Z88Y	31	F5300D79W	43	FH184RB	24	FH357ALB	46
F0808Z90Y	31	F6002X00M	34	FH184WT	24	FH357DSD	46
F0808Z97Y	31	F5600D00W	43	FH186IV	22	FH357NV	46
F0840A00Y	31	F5600D08W	43	FH186NV	22	FH357WT	46
F0870A00Y	60	F5600D10W	43	FH186SW	22	FH357WWH	46
F0900A008	41	F5600D79W	43	FH186WT	22	FH358BEG72	47
F0900A058	41	F60/** Range	91	FH210**	42	FH358BK72	47
F0900C008	41	F70/** Range	91	FH258SW	23	FH3582BRN72	47
F0900C058	41	F745BLKFR	61	FH258WT	23	FH358DSD72	47
F0906A***	40	F745CBUFR	61	FH259BK	23	FH358GY72	47
F0910A***	40	F745CHOFR	61	FH259BX	23	FH358WT72	47
F0948A***	40	F745GRNFR	61	FH259CR	23	FH359BK	46
F0950A***	40	F745GYFR	61	FH259EG	23	FH359GY	46
F0960A008	38	F745MOCFR	61	FH259GY	23	FH359LN	46
F0960A048	38	F745REDFR	61	FH259IV	23	FH359NV	46
F0960A068	38	F745WTFR	61	FH259NV	23	FH359RB	46
F0960A088	38	F80/** Range	91	FH259RB	23	FH359WT	46
F0960A108	38	F90/** Range	91	FH259SD	23	FH362II	20
F0960A138	38	FA862-0000 Ultrasuede	37	FH259SW	23	FH362WB	20
F0960A158	38	FHKP60WT	44	FH259WT	23	FH362WW	20
F0960A228	38	FH019BK	43	FH261CR	24	FH372CG	44
F0960A358	38	FH019GR	43	FH261SW	24	FH374BK	45
F0960A428	38	FH019RB	43	FH261WT	24	FH418BI	42
F0960A468	38	FH019RD	43	FH274BEG	58	FH418BK	42
F0960A518	38	FH019SR	43	FH274BG	58	FH418BU	42
F0960A528	38	FH019WT	43	FH274BK	58	FH418GY	42
F0960A538	38	FH019YE	43	FH274BU	58	FH418RD	42
F0960A568	38	FH058BK	39	FH274CGY	58	FH418WT	42
F0960A998	38	FH062BK	44	FH274CHB	58	FH418YE	42
F0960C008	38	FH062WT	44	FH274DRD	58	FH435CR	39
F0960C048	38	FH063WT	44	FH274FGR	58	FH435SD	39
F0960C068	38	FH154WT	27	FH274GR	58	FH435SVR	39
F0960C088	38	FH159BK	22	FH274LN	58	FH440WTP	39
F0960C228	38	FH159CR	22	FH274NV	58	FH441WTPF	39
F0960C468	38	FH159GY	22	FH274RD	58	FH442WT	39
F0960C518	38	FH159IV	22	FH274SLT	58	FH443WTF	39
F0960C538	38	FH159NV	22	FH274SFY	58	FH447WTP	39
F0960C580	38	FH159RB	22	FH274TC	58	FH449WTP	39
F0963A008	38	FH159SD	22	FH274WT	58	FH454AL	29
F0963A038	38	FH159SR	22	FH274YE	58	FH454BK	29
F0963A048	38	FH159SW	22	FH280BK	23	FH454GY	29
F0963A078	38	FH159TP	22	FH280CR	23	FH454WT	29
F0963A488	38	FH159WT	22	FH280SW	23	FH456WT	39
F0963A548	38	FH160BK	40	FH280WT	23	FH456BK	39
F0963A558	38	FH160GR	40	FH286BK	25	FH456GY	39
F0963C008	38	FH160RD	40	FH286BR	25	FH456BEG	39

Part No.	Page	Part No.	Page	Part No.	Page	Part No.	Page
FH462BK	26	FS4653	8-9	FS4888	10, 54	FS6046	8-9
FH462CWT	26	FS4654	8-9	FS4889	10, 54	FS6048	8-9
FH462DW	26	FS4655	8-9	FS4891	10, 54	FS6051	8-9
FH462II	26	FS4658	8-9	FS4894	10, 54	FS6052	8-9
FH462ID	26	FS4660	8-9	FS4895	10, 54	FS6053	8-9
FH462WB	26	FS4661	8-9	FS4896	8-9	FS6054	8-9
FH462WFG	26	FS4662	8-9	FS4897	8-9	FS6055	8-9
FH462WW	26	FS4663	8-9	FS4901	10, 54	FS6058	8-9
FH590BK	45	FS4664	8-9	FS4902	10, 54	FS6065	8-9
FH590WT	45	FS4665	8-9	FS4907	10, 54	FS6066	8-9
FH592WT	45	FS4666	8-9	FS4909	10, 54	FS6067	8-9
FH640BG	26	FS4667	8-9	FS4916	10, 54	FS6072	8-9
FH640BK	26	FS4668	8-9	FS4921	10, 54	FS6074	8-9
FH640BU	26	FS4671	8-9	FS4923	10, 54	FS6075	8-9
FH640DGY	26	FS4672	8-9	FS4932	10, 54	FS6076	8-9
FH640FGR	26	FS4673	8-9	FS4939	10, 54	FS6077	8-9
FH640LGY	26	FS4674	8-9	FS4945	10, 54	FS6078	8-9
FH640NV	26	FS4675	8-9	FS4946	10, 54	FS6079	8-9
FH640SD	26	FS4676	8-9	FS4948	10, 54	FS6083	8-9
FH656	27	FS4677	8-9	FS4949	10, 54	FS6084	8-9
FL291-000	36	FS4678	8-9	FS4954	10, 54	FS80001	8-9
FL303-000	36	FS4679	8-9	FS4955	10, 54	FS80008	8-9
FL398-000	36	FS4683	8-9	FS4959	10, 54	FS80028	8-9
FL393-000	36	FS4684	8-9	FS4961	10, 54	FS80030	8-9
FL363-000	36	FS4685	8-9	FS4969	10, 54	FS80031	8-9
FL335-000	36	FS4686	8-9	FS4985	10, 54	FS80037	8-9
FOLD	91	FS4688	8-9	FS4987	10, 54	FS80046	8-9
FP076	89, 138	FS4689	8-9	FS4988	10, 54	FS82000	11, 56
FP078	89, 138	FS4695	8-9	FS4989	10, 54	FS82002	11, 56
SENS**** Range	37	FS4696	8-9	FS4991	10, 54	FS82003	11, 56
FS4600	8-9	FS4697	8-9	FS4992	10, 54	FS82005	11, 56
FS4601	8-9	FS4698	8-9	FA4993	10, 54	FS82006	11, 56
FS4602	8-9	FS4699	8-9	FS4994	10, 54	FS82008	11, 56
FS4603	8-9	FS4751	10, 54	FS4995	10, 54	FS82010	11, 56
FS4604	8-9	FS4755	10, 54	FS5702	10, 54	FS82012	11, 56
FS4605	8-9	FS4762	10, 54	FS5704	10, 54	FS82013	11, 56
FS4606	8-9	FS4763	10, 54	FS6000	8-9	FS82014	11, 56
FS4607	8-9	FS4766	10, 54	FS6001	8-9	FS82015	11, 56
FS4608	8-9	FS4767	10, 54	FS6002	8-9	FS82016	11, 56
FS4609	8-9	FS4768	10, 54	FS6003	8-9	FS82017	11, 56
FS4610	8-9	FS4770	10, 54	FS6004	8-9	FS82030	11, 56
FS4612	8-9	FS4776	10, 54	FS6005	8-9	FS8401	11, 56
FS4614	8-9	FS4777	10, 54	FS6006	8-9	FS8404	11, 56
FS4615	8-9	FS4778	10, 54	FS6007	8-9	FS8408	11, 56
FS4616	8-9	FS4789	10, 54	FS6008	8-9	FS8417	11, 56
FS4617	8-9	FS4790	10, 54	FS6009	8-9	FS8428	11, 56
FS4618	8-9	FS4796	10, 54	FS6010	8-9	FS8430	11, 56
FS4620	8-9	FS4798	10, 54	FS6016	8-9	FS8437	11, 56
FS4621	8-9	FS4799	10, 54	FS6017	8-9	FS8442	11, 56
FS4622	8-9	FS4806	10, 54	FS6018	8-9	FS8446	11, 56
FS4623	8-9	FS4813	10, 54	FS6020	8-9	FS8479	11, 56
FS4624	8-9	FS4817	10, 54	FS6021	8-9	FS9408/0	10
FS4626	8-9	FS4855	10, 54	FS6022	8-9	FS9408/1	10
FS4628	8-9	FS4856	10, 54	FS6023	8-9	FS9433/0	10
FS4630	8-9	FS4857	10, 54	FS6024	8-9	FS9446/0	10
FS4631	8-9	FS4858	8-9	FS6026	8-9	FS9446/1	10
FS4633	8-9	FS4859	8-9	FS6028	8-9	FV163/202	57
FS4635	8-9	FS4860	8-9	FS6028TWD	8-9	FV165/208	57
FS4637	8-9	FS4861	8-9	FS6030	8-9	FV165/227	57
FS4640	8-9	FS4862	8-9	FS6031	8-9	FV165/411	57
FS4641	8-9	FS4864	8-9	FS6032	8-9	FV165/413	57
FS4642	8-9	FS4865	8-9	FS6033	8-9	FV165/414	57
FS4643	8-9	FS4868	10, 54	FS6037	8-9	FV165/440	57
FS4644	8-9	FS4876	10, 54	FS6040	8-9	FV165/452	57
FS4645	8-9	FS4878	10, 54	FS6041	8-9	FV165/502	57
FS4646	8-9	FS4879	10, 54	FS6042	8-9	G040BK	87
FS4648	8-9	FS4884	10, 54	FS6043	8-9	G040WT	87
FS4651	8-9	FS4885	10, 54	FS6044	8-9	G045BK	95
FS4652	8-9	FS4887	10, 54	FS6045	8-9	G045WT	95

Part No.	Page	Part No.	Page	Part No.	Page	Part No.	Page
G048BK	88	G149SS	68	G309	88	G636S	83
G049BK	88	G151	68	G371	88	G637PIN	79
G050BK	88	G151SS	68	G380	84	G638	85
G052BK	69	G152	68	G503S	85	G639	85
G053BK	69	G152OS	68	G504S	85	G640SCR	76, 80
G061	74	G153	68	G505S	85	G640SHD	76
G061LP	74	G154	68	G512	65	G641SHD	76
G062BK	74	G155	68	G512/24	65	G642S	76
G062WT	74	G156	68	G512BK	65	G645S	78
G063BK	74	G157	68	G515OW/24	65	G646S	78
G063WT	74	G158	68	G515WT/24	65	G647A	78
G100	70	G160ABK	74	G517WT/16	65	G651S	79
G101	70	G160AWT	74	G520	64	G655S	77, 83
G101FW	70	G160BK	74	G520-8	64	G656S	77, 83
G102	44	G160WT	74	G522A	82	G657S	83
G102A	70	G161BK	74	G523A	82	G670	88
G103	44	G161WT	74	G530	64	G671S	80
G103A	70	G164	75	G530OW/20	64	G672S	80
G103BP	70	G164GC	75	G535WT/95	65	G674S	80
G104	44	G165	75	G541WT/8	65	G675S	80
G104A	70	G165GCL	75	G550/0500	62	G677S	80
G104BP	70	G165GCS	75	G550/0625	62	G678S	80
G105	44	G165TOOL	75	G550/0815	62	G681S	80
G105A	70	G165GTOOL	75	G550/1029	62	G682S	80
G105FW	70	G166	75	G550/1315	62	G687S	76
G105MW	70	G167	75	G551/16	62	G692S	81
G106	70	G167GC	75	G551/18	62	G695BK	53
G106S	70	G167S	75	G552/16	62	G702S	78
G107/G107-25	70	G168	75	G554/15	62	G704S	78
G108	70	G170	69	G556	62	G710	82
G108BP	70	G171	68	G604S	81	G712	82
G110	70	G171FW	68	G605BK	81	G713	82
G113	70	G172	69	G605S	81	G718	82
G115S	70	G173	69	G605SHBK/HNT	81	G719LEFT/RIGHT	82
G116S	70	G174	42	G606S	81	G720S	82
G117	70	G175	68	G607S	81	G721S	50
G118	70	G176	69	G608S	81	G721STOP	50
G119A	70	G182	68	G610S	76	G722S	82
G119BP	70	G190BK	69	G611S	54	G723END	82
G119FW	70	G190WT	69	G615S	78	G730S	76
G120A	70	G191BK	69	G617	104	G731S	78
G120BP	70	G191WT	43	G620BK	77	G738	85
G130A	70	G192BK	69	G620S	76	G742S	104
G130BP	70	G192CLR	69	G620SS	80	G744S	80
G130LP	70	C192WT	69	G621BK	77	G747S	80
G140	68	C193CLR	69	G621S	76	G750S	83
G140BK	68	G194BK	69	G621SHD	76	G750SSET/3	83
G140BKM	68	G194WT	69	G622BK	77	G751S	83
G140BS	68	G200S	104	G622S	79	G751SSET/3	83
G140BU	68	G201N	106	G622SS	56	G751SSET/6	83
G140CGY	68	G201S	106	G623SS	80	G758	80
G140HBG	68	G202S	106	G624S	79	G759	80
G140NV	68	G203S	104	G625LAN	79	G760	83
G140SS	68	G204N	104	G625PIN	79	G761	83
G140TST	68	G204S	104	G625S	79	G761/10	83
G140WT	68	G205S	106	G625SQP	79	G770S	76
G141	68	G209S	106	G626S	79	G771S	78
G141L	68	G210S	105	G627PIN	79	G820S	77
G141SS	68	G211S	105	G628S	79	G820SSP	77
G142	68	G213ST	104	G628SQP	79	G830S	77
G142SS	68	G215S	104	G629S	79	G830SSP	77
G143	68	G221	105	G630S	76	G840S	77
G143SS	68	G221S	105	G630SHD	76	G840SSP	77
G144	68	G222S	105	G631S	76	G842S	77
G145	68/69	G225S	86	G631SHD	76	G845S	58
G145SS	68	G246S	35	G632S	79	G846S	84
G146	68/69	G252S	35	G633S	83	G848S	85
G147	68	G300A	85	G634LT	79	G850	74
G148	68	G308	88	G635S	83	G852	74



Part No.	Page	Part No.	Page	Part No.	Page	Part No.	Page
G854	74	J601GR	111	LS603WT	41	NN40/0/***	132
G858S	86	J601HP	111	LS605OWT	41	NN42/0/***	132
J005BK	110	J601LB	111	LS605WT	41	NN43/0/120	132
J005BU	110	J601RD	111	LS613BK	38	NN43/0/130	132
J005RD	110	J601SR	111	LS613CK	38	NN44/0/***	132
J007BK	110	J601WT	111	LS613DGWT	38	P14938	44
J007BU	110	J603	111	LS613DSWT	38	P44015	86, 96
J007GY	110	J610WT	111	LS613DWT	38	Q030	74
J007RD	110	J613WT	111	LS613LGL	38	Q031	74
J009BK	110	J872	111, 148	LS613ML	38	Q032	74
J009BU	110	J874	111, 148	LS613PN	38	Q034	74
J009RD	110	J939	149	LS613SC	38	Q381	121
J051	111	J959	149	LS613SW	38	Q382	121
J052	111	J959LVOC	149	LS613BK	39	WA102	62
J053	111	J969	148	LS622CK	39	WA122	62
J071	111	J970	148	LS622GEL	39	WA130	62
J072	111	J971	148	LS622ML	39	WA140	62
J073	111	J972	148	M003	118	WA145	62
J074	111	J979	149	M004	118	WA160	62
J076	11	K120/10	51	M005	147	WA171	62
J090	114	K130/5	51	M009	144	WA172	62
J091	114	K140/3	51	M010	144	WA202	62
J092	114	K140/5	51	M012	143	WA204	62
J112V	64, 148	K140/5LSM	51	M013	143	WSZ001	62
J117V	64, 148	K221	49	M016	143	WSZ007	62
J132	113	K222	49	M020	143	WSZ031	62
J180	115	K222/5	49	M021	143	WSZ032	62
J181	115	K223	49	M030	127	WSZ101	62
J182	115	K225/3	49	M031	127	WSZ122	62
J183	115	K225/5	49	M032	127	WSZ130	62
J351	113	K226/3	49	M040	148	WSZ140	62
J352	113	K227/3	49	M041LVOC	148	WSZ142	62
J353	113	K227/5	49	M047	147	WSZ145	62
J412	113	K228/3	49	M048	147	WSZ147	62
J413	113	K228/3SM	49	M0601/16	145	WSZ160	62
J415	113	K228/5	49	M0602/16	145	WSZ171	62
J416	113	K229/3	49	M0603/16	145	WSZ172	62
J440	112	K230	52	M0603/128	145	WSZ175	62
J441	112	K231FR	52	M150	147	WSZ202	62
J442	112	K232	52	M151	147	WSZ203HD	62
J443	112	K305/2	51	M170KIT	146	WSZ301	62
J444	112	K305/5	51	M171	146	YUL12**	92
J445	112	K310/2	51	M172	146	YUL16**	92
J446	112	K310/2SM	51	M173	146	YUL20**	92
J448	112	K310/5	51	M174KIT	146	YUL24**	92
J451	113	K310/5SM	51	M180	146	YUL28**	92
J452	113	K315/2	51	M181	146	YUL32**	92
J453	113	K315/2LSM	51	M182	146	YUL36**	92
J454	113	K333	52	M183	146	YUL40**	92
J455	113	K333FR	52	M185	146	ZBAG7	136
J456	113	K334	52	M210/14	146	ZMARKERWT	89, 138
J472	114	K432	52	M210/7	146	ZPENCILBU	89, 138
J492	114	K434	52	M211/15	146	ZPENCILSW	89, 138
J493	114	K631	52	M212	38, 118		
J514BK	110	L520	64	M216	147		
J514BU	110	L555	64	M221/128	146		
J514FP	110	L575	64	M221/4	146		
J514GR	110	L575BK	64	M221/16	146		
J514GY	110	L575T	64	M222/4	146		
J514OR	110	L585	64	M222/16	146		
J514RD	110	L585BK	64	M224/16	145		
J514WT	110	L705BKA	66	M224/128	145		
J514YE	110	L710BK/WT	66	M301	133		
J530WT	110	L712BK	66	M305	133		
J530WTUV	110	L715VBK/VWT	66	M321	133		
J550WT	110	L717BK	66	M322	133		
J601BK	111	L718BK	66	M401	147		
J601BU	111	LS401BG/BK/BU/GY/TN	85	M402	147		
J601GD	111	LS603OW	41	NN30/0/***	132		

# Index By Product Name

1.9oz 70d Ripstop Nylon	43
210 Cleaner & Polish	53
210d Oxford Nylon	43
303	
Fabric Cleaner	145
Fabric Guard	144
UV Protection	144
3M	
Adhesive Spray	38,122
Adhesive Remover	88,122
Super Seam Tape	93
VHB Attachment Tape	64,148
420d Nylon Pack Cloth	43
1000d Texturized Nylon	43

## A

Acrylic		
Awning Braid	19	
Binding Tape	17-19	
Cover Fabrics	8-16	
Nautex Premium	14	
Seaming Tape	112-115	
SeaMark	15	
Sunbrella	8-9	
Sunbrella Stripe	10-54-55	
Adhesive		
Fastener (SNAD)	69	
Remover	148	
Velcro	130	
Spray	149	
Tapes	112-115, 64,148	
Velcro	104	
Adhesive Tapes Double Sided	112-115	
Slit Insignia	110	
Adjustable Eye Ends	84	
Adjustable Mooring Poles	88	
Adjustable Shockcord Hook	73	
Adjuster Buckles	105	
Airx Spinnaker Fabrics	90	
All-Purpose Spinnaker Fabrics	90	
Aluminum		
Aluminum Awning Fittings	63	
Awning Rail	64	
Adjustable Awning Poles	88	
Rulers	139	
Tubing	62	
Anti-Wick Thread	118	
Aquatech - Cleaner & Protectant	49	
Aqua-Tite Green - Water Repellent	147	
Aramid Tape	92	
Arch Hole Cutters	137	
Awls	112, 135, 138	
Awning		
Brackets	62-63	
Braid	19	
Fabrics	8-11, 55-61	
Fittings - Aluminum	63	
Fittings - Steel	63	
Pipe & Tubing	62	
Poles	88	
Pulleys	62	
Rope	64	
Seal by Xtreme Seal	66	
Tapes	62	
Track	64-65	
Tubing	62	
Welt Cord	64	
B		
Bag		
Cloth	105	
Riggers Tool	136	
Grey Sailcloth Barrel Bag	150	
White Sailcloth Barrel Bag	150	
White Deluxe Sailcloth Holdall	150	

Bainbridge Sailcloth Washbag - Small	151
Bainbridge Sailcloth Washbag - Large	151
Bainbridge Sailcloth Tote Bag	151
Bainbridge Diax Sailcloth Barrel Bag	151
Bainbridge Diax Sailcloth Holdall	151
Bainbridge Sailcloth Bags	150-151
Bainbridge Polyester Thread	95
Bainflate 210 Fabric	42, 146
Baintex 500 Awning Fabric	60
Baintex 600 Fabric	42
Ball & Socket Fittings	76, 80
Barrel Locks	94
Battens, Sailmaking, Pultruded	90
Batten, Lofting Fiberglass	139
Beeswax	121
Bench	
Press	72
Press Dies	72
Mount Hot Knife	142
Bendarc Tube Bender	58
Binding Tape	17-19
Boat Cover Socket	88
Boat Top	
Acrylic Fabric	8-16
Cover Socket, Bow Slat	88
Fittings	76-83
Frame Set	82
Marine Topping	27
Nautex Premium	14
Odyssey	30
Odyssey PSA	31
Polyester Fabric	26-32
Santa Cruz	26
Seamark	15
Stamoid	22-25
Sunbrella Solids	8-9
Top Gun	28
Top Gun 9	29
Top Gun FR	59
Top Notch 1S	33
Top Notch	32
Top Notch 9	32
Weblon	26
Boat Vent II	88
Boat Vent 3	88
Bobbins	117
Bolster Clip, Stainless Steel	35
Bow Slat	88
Bracket	
Awning U	62-63
Awning Z	62-63
Brass	
Grommets	97-99
Buckles	104-105
Button Snap Fasteners	68-69
C	
Cable Cutters	141
Cam Buckles	104
Canopy Fittings	51-57
Cantech Upholstery Vinyl	39
Canvas Clip	58
Carabiner Hook	102
Carabiner Quick Link	102
Center Release Buckles	83
Chalk	138
Channel	
Upholstery	28, 29, 31
Cantech	29
Nautolex	31
Seabrook	28
China Marker	68, 112
Clamcleats	93
Clamps	
Cloth	66, 110
Shockcord	72

Cleaners		
Fabric	118, 121	
Mildew	118	
Plastic	32	
Clear-VU Window Vinyl	52	
Cleats	93	
Closing Tools		
Button Snaps	43	
Grommet	75-77	
Nicopress	74	
Coats North America - Advertisement	97	
Cloth Clamps	68, 110	
Coil Zip	99	
Colored Shockcord	94	
Commonsense™ Fasteners	70	
Drill Tool	71	
Hand Setting Tool	71	
Cone Hooks	73	
Continuous Zipper- Coil	99	
Continuous Zipper- Vislon	100	
Cord Lock	94	
Cordage	71	
Countryview by Strataglass	50-51	
Cover		
Acrylic Cloth	8-16	
Poly/Dacron Cover Cloth	27	
Fabrics	8-33	
Fasteners	68-70, 74-75	
Fittings	76-83	
Frame Kits	50	
Hooks	61	
Polyester Cloth	26-33	
Sockets	64	
Tapes	62	
Trax System	63	
Vinyl Cloth	18-21	
Crownarc	58	
Cruising Wovens -Ocean Sailcloth	90	
Crystal Clear 20/20	51	
Custom Slitting Service	90	
Cutting		
Equipment	136-137	
Pads	136	
Punches	137	
Cutters		
Cable	115	
Hole	47	
Wire	115	
D		
D Rings	100-102	
Dabond Thread	117-119	
Deck Fittings	78,79, 81-82	
Dome Fastener (SNAD)	69	
DOT Fasteners	68-71	
DOT/Scovill Fasteners Inc. - Advertisement	48	
Double Braid, Yale Line	92	
Double Sided Seaming Tape	112-115	
Draft Stripe tape	110	
Drill Steady	85	
Duo Track System	82	
E		
Edging Tapes	91	
Elastic Shock Cord	94	
Eye End Fittings	76,77,84	
Engel Hot Knives	142	
English Grommets	76	
Evolution 4	27	
Eyelets	75-77	
Eye Straps	104	
F		
Fabric		
Awning	8-11, 55-61	

Boat Cover	6-23
Cleaners	145
Mesh	39-41
Sailcloth	69
Upholstery	26-31
Window	32-34
Fabric Guard	121
Facings, Acrylic	16
Fasteners	68-70, 74-75
Fiberglass	Bow Slat 88
	Lofting Batten 109
	Screen 39
Fender Hook	60
Firesist 3	11, 56
Fittings	Boat Top 51-58
	Awning
Flex-A-Rail	63
Foam	Adhesive 38, 122
	Welt Cord 29
Folded Tape	91
Footman Loop	106Frame Kits 50
Furniture Fabric	Nautolex 31
	Seabrook 28
	Sensuede 27
	Sunbrella 11, 27
	Ultraleather 26
	Ultrasuede 27
<b>G</b>	
Gatorshield Tubing	62
Gemlock Strut	83
Gemini Hinge	83
Glen Raven, Inc. - Advertisement	13
GORE Tenara Thread	122-123
Grab Rail Fittings	85
Grommets	97-99
Groz-Beckert Needles	119, 132
Guard Rail Netting	44
<b>H</b>	
Haartz Marine Topping	27
Hammers	137
Hand Punch	137
Hand Sewing	Needles 134
	Palms 134
	Thread 121
	Wax 121
Headliner	39
Heat Control Unit	143
Heminway & Bartlett Thread	117-119
Hole Punches	137
Hook & Loop, Velcro	130
Hoop & Loop, Economy	131
Hooks	Adjustable Plastic 95
	Carabiner 102
	Fender 86
	Inflatable Boat Hook 86, 96
	J-Hook 86
	Plastic J-Hook 86
	Plastic Snap Hook 104
	Rivet-On Cover Hook 87
	Shockcord 95
	Snap 103-104
	Sew-On Cover Hooks 87, 95
	Tie Down 82
	Washer, Rigid 35, 131
	Wire Cover Hooks 87
Hot Knives	142-143
Hull LIner	39

## I

IMAR	Protective Cleaner	53, 146
	Protective Polish	53, 146
	Stamoid Protection	145
	Yacht Soap	53
Inflatable Boat Hook		86, 96
Industrial Shears		140
Insignia	Cloth	110
	Tapes	110-111
Iosso	Mildew Remover	145
	Seam Sealer	147

## J

J-Hook		60
Jacket Zippers		102-103
Jaw Slides		76, 77
Joining Tape		90-93

## K

Keder	Tape	64
	Track	64
	Track Slide	64
Kevlar Webbing		106
Kneepads		136

## L

Lacing Cord		92
Lacing Knobs		87,95
Ladderlock Buckles		105
Lanyards		79
Leather		136
Leechline		92
Leno Mesh		39
Lift-the-Dot® Fasteners		70
Lift-the-Dot® Tools		71
Lofting Battens		139
Loop Loc		105
LOXX Fasteners		75
Lubricant	McLube	147
	Teflon	147
	Thread	133
	Sewing Machine Oil	133
	Zipper	127
LVOC Adhesive Remover		148
LVOC Spray Adhesive		149

## M

McLube, Sailkote		147
Marine Headliner		39
Marine Hull Liner		39
Machine Oil		133
Marlen Textiles Inc. - Advertisement		34
Marine Topping Vinyl		27
Marking Pencils		89
Marking Out Chalk		138
Mauls		137
Measuring Tapes		89,139
Mesh Fabrics		44-47
Mildew Cleaner		118
Mildew Protector		118
Mini Brite Light		60
Monofilm		53
Mooring Poles		88
Mooring Pole Base		88
Mosquito Netting		44

MP-75		90
MP-90		90
Multi Purpose Spinnaker Nylon		69
Mylar Clear Film with Adhesive		111
Mylar Pattern Material		139

## N

Nautex Premium		13
Nautolex	Upholstery Fabric	40-41
	Underlining	39
	Channel Fabric	41
	Hidem	41
	Voyager	40-41
	Welt	41
Needles	Hand	108
	Machine	106
Netting, Mosquito		44
No-See-Um Netting		44
Novus Plastic Polish		49, 146
Nylon	1.9oz 70d Ripstop	105
	Adhesive Sailcloth	90
	Bag Cloth	105
	Boat Fittings	77, 81
	Cord	92
	Diamond Braid	92
	Cutting Pads	136
	Multi-Purpose	105
	Performance	69
	RIPair Tape	88
	Sailcloth	90
	Sailcloth Tape	70
	Shockcord	94
	Velcro	104
	Webbing	106,107,109

## O

Ocean	Sailcloth	90
	Ocean Colours	90
	Ocean UV	90
	Ocean Storm Orange	90
Odyssey	FR Fabric	31
	Cover Fabrics	30
	Soft Touch	31
	PSA	31
Oil Bottle		133
O'Sea Clear Window Vinyl		48-49
O'Sullivan Firms Inc. Advertisement		48
Oxford 210d Nylon Fabric		105

## P

Pack Cloth		43
Pads	Cutting	110
	Knee	110
Palms		134
Pattern Material		89, 138, 139
Pattern XX		89, 138
Pencils		89, 139
Perforated Headliner		29
Performance Spinnaker Fabrics		69
Permalock Fasteners		74
Plastiseam		118
Pliers	Shock Cord Clamp	72
	Stapling	135
	Vise	73
Polyester	Cover Fabrics	26-32
	Insignia Cloth	110-111
	Lacing Cord	92
	Leechline	92

Mesh	44-45
Ropes	91 - 92
Sailcloth	90
Sail Repair Tape	111
Insignia Tape	88-89
Sailcloth Tape	91
Sailtwine	96
Shockcord	94
Solid Braid Cord	92
Spun 3-Strand Braid	92
Velcro	130
Webbing	107
Polypropylene Webbing	108-109
Pony Clamp	89, 136
Pneumatic Staple Gun	35, 135
Press-N-Snap Tools	73
Dies	73
Pre-Wound Bobbins	117
Proofing Spray	115, 117
Pro Seal by Xtreme Seal	66
Protectants	303 Fabric Guard 121
303 UV Protection	121
Water Proofing	118-121
Pull-the-Dot	69
Pulleys, Awning	62
Punches	Hole 137
Lift-the-Dot Fasteners	45
Permalock	
Snap Fasteners	
Commonsense Fasteners	44
Push Pins	138
PVC Insignia Cloth	110
<b>Q</b>	
Quick Fit Kit	69
Quick Release Buckle	104
<b>R</b>	
Regalite Window Material	49
Regatta, Webblon	26
Revolving Tube Punch	137
Riggers Tool Bag	136
Rings	78-80
D Rings	100-102
O Rings	100-102
Nickel Plated	102
Quick Link	102
Stainless Steel	100-102
RIPair Tape	88
Rippers, Seam	141
Ripstop Nylon	Spinnaker Cloth 90
Rivets	Speedy 86
Roll-A-Glass	52
Rope	92
Rubber Based Seaming Tape	112-115
Rules, Tapes/Measures	113, 139
<b>S</b>	
S Hooks	73
Sail	Grommets 75-77
Kote McLube	147
Rings	78-80
RIPair Tapes	111
Ripair Tape Box	111
Reinforcement Tape	70
Twine	96
Sailcloth	90
Spinnaker	90
Tape	91

Woven Polyester	90
Sailmaker's	Chalk 112
Leather	38, 110
Needles	1134
Palms	134
Wax	121
Santa Cruz Cover Fabric	26
Sattler	Nautex Premium 14
745FR Awning Vinyl	61
Scissors	140
Scratch Remover210	53
Novus	49, 146
Seam-Kote 4	147
Seam Sealer	147
Seam	Rippers 141
Rollers	115
Seaming Tape	112-115
Seamstick	90-93
Seabrook Upholstery Vinyl	38-39
SeaMark	15
Seat Belt Webbing - Polyester	107
Seizing Wire	96
Self Adhesive Cloth	110
Self Piercing Grommets	97
Sensuede	37
Serge Ferrari North America - Advertisement	21
Sewing	Awls 135
Machine Oil	133
Needles Hand	108
Machine Needles	119, 132
Palms	108
Thread	94-96
Sew On Cover Hooks & Eyelets	87, 95
Sew On Eyelet	96
Shears	140
Shelter-Rite	42
Shock Cord	94
Shock Cord Adjustable Hook	95
Shock Cord Clamps	95
Shock Cord Cover Clip	87
Shockcord End	94
Shock Cord Hooks	95
Shock Cord Lacing Knobs	87, 95
Shock Cord S Hook	95
Shockcord to Webbing Connector	94
Side Hole Cutters	137
Side Release Buckles	105
Simple Setter Tool	44
Shock Cord Pliers	94
Sleeveknit Mesh	45
Slides - Keder Track	62
Sliding Bar Buckles	105
Slit Tape	91
SNAD Fasteners by YKK	69
Snap	Buckles 83
Fasteners	42
Hooks	103-104
Snapfast Fasteners	74
Snapmaster Tool & Dies	72
Snips, Thread	141
Socket, Boat Cover	88
Soltis 86 Mesh	25
Spectra Webbing	106
Speedy Rivets	86
Split Jaw Slides	55
Spinnaker	Fabrics 90
RIPair Tape	
Spray	Adhesive 3M 122
Fabric Proofing	119, 121
Hood Fittings	51-57
Lubricants	119

Welt, Adhesive Backed	66
Stamoid	Bindings & Facings 20
Fabric Range	22-25
Mesh	25
Protection, IMAR	
Stainless Steel	Boat Top Fittings 76-83
Grab Rail Fittings	85
Grommets	97
Rings	100-102
Shears	114
S Hooks	95
Tubing	85
Thimbles	96
Staplers	35, 131, 135
Staple Removers	35, 131, 135
Staples	35, 131, 135
Stapling Pliers	135
Stayput Fasteners	74
Steel Awning Fittings	67
Stimpson Co. Inc. - Advertisement	99
Stimpson Grommets	97-99
Storm Orange Sailcloth	90
Strataglass Cleaners & Polish	53, 146
Strataglass, LLC - Advertisement	50
Strataglass Window Material	51
Sunbrella®	Advertisement 13
Acrylic Fabric	8-13
Bindings	17-19
Care & Cleaning	16
Facings	19
Furniture	12, 37
Plus	11, 56
Stripes	54-55
Sunblocker Clips	85
Sun Sox	85
Sunstop Thread	17, 120
Sunsure Mesh Fabrics	46
Super Clear FR Roll Glass	52
Super Tramp Mesh Fabric	44
Snaps	42-43
<b>T</b>	
T-Nuts, Stainless Steel	35
Tape	Awning 62
Binding	15-17,
Camber/Draft Stripe	89
Double Sided	112-115
Insignia	88-89
Keder	64
Joining	112-115
Measures	89, 139
Seaming	112-115
RIPair®	88
Sailcloth	70
Seaming	90-93
Tesa	92
Waxed Lacing	96
3M VHB	64,148
Teflon	Spray Lubricant 146
Tenara Thread	122-123
Tenax Fasteners	75
Textilene Mesh Fabrics	46-47
Thimbles	96
Thread	Anti-Wick 118
Bainbridge Thread-4oz	120
Bainbridge Thread-16oz	119
Bobbins	95
Dabond	116-119
Hand Sewing	121
Heminway & Bartlett	116-119

	Lacing Tape	121
	Lubricant	133
	Lubricator	133
	Machine	116-119
	Snips	141
	Sunstop	17, 120
	Tenara	122-123
Tools	Awls	112, 138
	Bags	136
	Bench Press, Dies	72
	Button Snap	43
	Cable Cutters	141
	Commonsense™	44
	Drill Steady	85
	Grommet	97-99
	Hot Knives	142-143
	Lift-The-Dot	45
	LOXX	75
	Permalock	74
	Press-N-Snap	73
	Revolving Tube Punch	137
	Seam Rippers	115
	Snapmaster	72
	Shockcord Pliers	94
	Tenax	75
	Top Gun Cover Fabric	28
	Top Gun 9 Cover Fabric	29
	Top Gun FR Fabric	59
	Top Notch Cover Fabric	32
	Top Notch 1S Cover Fabric	33
	Top Notch 9 Cover Fabric	33
	Top Snapper	141
Track	Awning	64-65
	Cover Trax	65
	Flex-A-Rail	65
	Keder	63
	Slides	64
	Screws	65
Trampoline Cloth		44-45
Triangles	Plastic	82
	Stainless Steel	100
Tri Glide		105
Trim Adhesive		38, 122
Tube Benders		58
Tubing, Aluminum		85
Tubing, Awning		66
Tubing, Stainless Steel		85
Turnbutton Fasteners		44
Twine, Whipping		96
Tylaska Snap Setter Tool		71
<b>U</b>		
U Bracket, Awning		62-63
Ultraleather		36
Ultra Seal by Xtreme Seal		66
Ultrasuede		37
Ultra Torch		142
Ungar Hot Knives		143
Upholstery Fabric		36-41
Upholstery Vinyl		38-41
Universal Boat Frame Kits		50
Universal Deck Hinges		52-53
UV Cloth - Insignia		89
UV Protector - 303		121
<b>V</b>		
V Seal by Xtreme Seal		66
Vadney Clip		69
Velcro®		130

Vinyl	Adhesive - HH-66	148
	Bainflate 210	42
	Binding Tape	20
	Boat Top	21-26
	Cantech Upholstery	29
	Cleaner	121-122
	Clear-Vu Window	52
	Fabrics	18-21
	Insignia Cloth	110
	Nautex Premium	14
	Nautolex Voyager	40-41
	31	
	Marine Topping	27
	Mesh	45-47
	Sattler 745FR	61
	Seabrook	28
	Seamark	15
	Shelter-Rite	42
	Stamoid	22-25
	Upholstery	38-41
	Vinagard Awning Fabric	57
	Weathertyte/Lite	58
	Weblon	26
	Window Clear	48-52
Vise Pliers		73
Vislon Zipper		125-129
Voyager, Nautolex Upholstery Fabric		40-41
<b>W</b>		
Water Proofing		147
Wax		121
Waxed Lacing Tape		121
Waxed Thread		121
Webbing		106-109
	Attachments	104-105, 106
	Bridge	106
Weblon		26
Welded Rings		100-102
Welt	Foam Cord	35
	Hollow Core Tube	35
	Spray	66
Whipping Twine		121
William Smith	Palms	134
	Sail Needles	134
Window Material		32-34
Wire, Seizing		74
Wire Cutters		115
Wiss Shears		140
Woven Sailcloth-Ocean		69
	-Ocean Colors	69
<b>X</b>		
X-Glass		53
Xtreme Seal		66
<b>Y</b>		
Yale Double Braid Line		92
YKK Continuous Coil Zippers		124
YKK Continuous Vislon Zipper		125
YKK #5 & #8 Vislon Jacket Zippers		127
YKK #10 Vislon Jacket Zippers		128-129
YKK SNAD Fasteners		69
YKK Zippers		124-129
YKK Zipper Stops		126
<b>Z</b>		
Z Bracket, Awning		62-63

Zipper	124-129
Zipper Cleaner	127
Zipper Pulls	127
Zipper Cars/Sliders	99, 100
Zipper Stop Pliers	126
Zippy Cool	127

## Advertiser Index

Coats North America	116
Continental	48
DOT/Scovill Fasteners Inc.	66
Glen Raven, Inc.	13
Golden Eagle Inc./303 Products	144
Herculite/Strataglass	50
Marlen Textiles Inc.	34
Serge Ferrari North America.	23
Sattler USA	N4
Stimpson Co. Inc.	99
W.L.Gore/Tenara	122

# Fabric Comparison Chart

Description	Part #	Width	Weight	Roll	FR	Warranty	Colors	Page
<b>Acrylic</b>								
Sunbrella 46"	FS46**	46"/1170mm	9oz Sq Yd/305 gsm	65 Yds/59m	No	10 Year Limited	63	8/9
Sunbrella 60"	FS60**	60"/1530mm	9oz Sq Yd/305 gsm	65 Yds/59m	No	10 Year Limited	47	8/9
Sunbrella 80"	FS800**	80"/2030mm	9oz Sq Yd/305 gsm	65 Yds/59m	No	10 Year Limited	7	8/9
Sunbrella Stripes	FS47/48/49/55**	54"/1372mm	9oz Sq Yd/305 gsm	65 Yds/59m	No	10 Year Limited	60+	10
Sunbrella Plus	FS84**	60"/1530mm	10.25oz Sq Yd/348gsm	65 Yds/59m	No	10 Year Limited	8	11
Sunbrella Furniture	FS	54"/1372mm	8oz Sq. Yd/271gsm	65 Yds/59m	No	5 Year Limited	100+	12
Seamark	F0400A**Y	60"/1530mm	15oz Sq Yd/509gsm	65 Yds/59m	No	5 Year Limited	17	15
Nautex Premium	F06344***	60"/1530mm	10oz Sq Yd/340gsm	50 Yds/45.7m	No	5 Year Limited	10	14

## Polyester

Firesist	FS82***	60"/1530mm	8.75oz Sq Yd/297gsm	65 Yds/59m	Yes	5 Year Limited	13	11
Baintex 500	F0870A00Y	60"/1530mm	7.9oz Sq. Yd/268gsm	50 Yds/45.7m	Yes	-	White	60
Santa Cruz	FH640**	60"/1530mm	9.3oz Sq. Yd/315gsm	65 Yds/59m	No	5 Year Limited	8	26
Cover Cloth	F2610/20/30	54"/1372mm	5.8-8.9oz/197-302gsm	100 Yds/92m	No	-	White	27
Top Gun	F0300A**	62"/1570mm	11.5oz Sq. Yd/373gsm	50 Yds/45.7m	No	5 Year Limited	20	28
Top Gun 9	F0550A**	62"/1570mm	9oz Sq. Yd/305gsm	50 Yds/45.7m	No	4 Year Limited	14	29
Top Gun FR	F0350A**	62"/1570mm	12oz Sq. Yd/407gsm	50 Yds/45.7m	No	5 Year Limited	10	59
Top Notch	F0200A**	60"/1530mm	11.5oz Sq. Yd/373gsm	50 Yds/45.7m	No	5 Year Limited	12	32
Top Notch 9	F0700A**	60"/1530mm	9oz Sq. Yd/373gsm	50 Yds/45.7m	No	5 Year Limited	10	33
Top Notch 1S	F0650A00Y	60"/1530mm	7.5oz Sq. Yd/255gsm	50 Yds/45.7m	No	3 Year Limited	Black	33
Odyssey	F0800A**	64"/1630mm	6.5oz Sq. Yd/220gsm	75 Yds/68.6m	No	3 Year Limited	18	30
Odyssey FR	F0840A00Y	64"/1630mm	6.5oz Sq. Yd/220gsm	75 Yds/68.6m	No	3 Year Limited	White	31
Softtouch	F0805**	60"/1530mm	12.5oz Sq. Yd/405gsm	50 Yds/45.7m	No	3 Year Limited	10	31

## Vinyl Coated

Stamoid Top - Light	FH159**	59"/1500mm	8.3oz Sq Yd/254gsm	54 Yds/50m	No	5 Year Limited	11	22
	FH180**	80"/2100mm	8.3oz Sq Yd/254gsm	32 Yds/30m	No	5 Year Limited	8	22
	FH186**	102"/2591mm	8.3oz Sq Yd/254gsm	32 Yds/30m	No	5 Year Limited	3	22
Stamoid Top - Heavy	FH259**	59"/1500mm	12.7oz Sq Yd/441gsm	54 Yds/50m	No	5 Year Limited	11	23
	FH280**	80"/2030mm	12.7oz Sq Yd/441gsm	54 Yds/50m	No	5 Year Limited	4	23
	FH258**	102"/2591mm	12.7oz Sq Yd/441gsm	32 Yds/30m	No	5 Year Limited	2	23
Stamoid Heavy Cover	FH184**	102"/2591mm	13.7oz Sq Yd/465gsm	32 Yds/30m	No	5 Year Limited	3	24
Stamoid Open	FH182BK	72"/1824mm	19.1oz Sq Yd/650gsm	32 Yds/30m	No	5 Year Limited	Black	25
Stamoid Open	FH182**	102"/2591mm	19.1oz Sq Yd/650gsm	32 Yds/30m	No	5 Year Limited	3	25
Stamoid Pure	FH261**	59"/1500mm	12.7oz Sq. Yd/441gsm	54 Yds/50m	No	5 Year Limited	3	24
Soltis 86	FH286**	70"/1770mm	11.2oz Sq. Yd/380gsm	54 Yds/50m	No	5 Year Limited	5	25
Sunsure/Plus	FH37/359**	54"/1370mm+	14.3oz Sq. Yd/485gsm+	60 Yds/54m+	Yes	-	6+	46
Textilene/Plus/80/90	FH352/4/5/8**	54"/1370mm+	10.3oz Sq. Yd/350gsm+	65 Yds/59m+	Yes	-	6+	46/47
Weatherlyte	FH274**	74"/1890mm	16oz Sq Yd/542gsm	50 Yds/45.7m	Yes	8 Year Limited	16	58
Weatherlyte Lite	FH174**	74"/1890mm	11oz Sq Yd/380gsm	50 Yds/45.7m	Yes	5 Year Limited	7	58
Sattler 745FR	F745***	98"/2500mm	18.9oz Sq. Yd/641gsm	50 Yds/45.7m	Yes	8 Year Limited	8	61
Bainflite 210	FH210**	60"/1530mm	7.5oz Sq. Yd/255gsm	100 Yds/92m	No	-	12	42
Shelter Rite 18	FH418**	61"/1550mm	18oz Sq. Yd/610gsm	110Yds/101m	No	-	7	42
Shelter Rite 22	FH422**	61"/1550mm	22oz Sq. Yd/746gsm	110Yds/101m	No	-	2	42
Vinagard 16	FV163/***	61"/1550mm	16oz Sq Yd/542gsm	54 Yds/50m	Yes	-	9	57

## Vinyl Laminated

Marine Topping	FH154WT	60"/1530mm	23oz Sq. Yd/780gsm	60 Yds/55m	No	-	1	27
Weblon Regatta	FH462**	62"/1570mm	13oz Sq. Yd/475gsm	50 Yds/45.7m	No	5 Year Limited	8	26

## Common Conversions

To convert these common dimensions, weights and volumes, please use the formulae below.

### Length

To Convert	Into	Multiply By
Inches	Millimeters	25.4
Feet	Meters	0.3048
Yards	Meters	0.9144
Miles	Kilometers	1.609

### Area

To Convert	Into	Multiply By
Square Yards	Square Meters	0.836
Square Meters	Square Yards	1.196

### Weight

To Convert	Into	Multiply By
Ounces	Grams	28.35
Pounds	Kilograms	0.4536
U.S. Tons	Metric Tonnes	0.9072
U.S. Tons	Imperial Tons	0.8929
Grams	Ounces	0.0353
Kilograms	Pounds	2.2046
Metric Tonnes	U.S. Tons	1.1023
Metric Tonnes	Imperial Tons	0.9842

### Volume

To Convert	Into	Multiply By
U.S. Gallons	Imperial Gallons	0.8326
U.S. Gallons	Liters	3.785
Liters	U.S. Gallons	0.2642
Liters	Cubic Feet	0.0353
Cubic Feet	U.S. Gallons	7.481
Cubic Feet	Liters	28.317

### Fabric

To Convert	Into	Multiply By
Sailmaker's Ounces	Ounces/Square Yard	1.263
Sailmaker's Ounces	Grammes/Square Metre	42.83
Grams/Square Meter	Sailmaker's Ounces	0.0233
Grams/Square Meter	Ounces/Square Yard	0.0295
Ounces/Square Yard	Sailmaker's Ounces	0.792
Ounces/Square Yard	Grammes/Square Metre	33.91
Denier	Decitex	1.12

### Film Thickness

To Convert	Into	Multiply By
Mil	Millimeters	0.0254
Mil	Microns	25.4







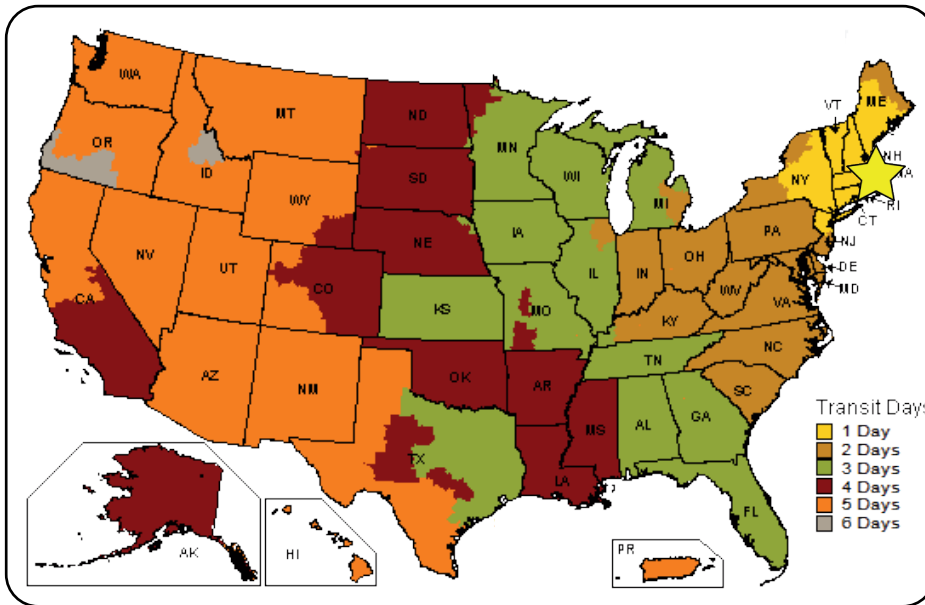

## Approx. Time In Transit Ground Service From Canton, MA 02021



### Please Note:

All ground service transit times are approximate business days, are not guaranteed and are meant for guidance only.

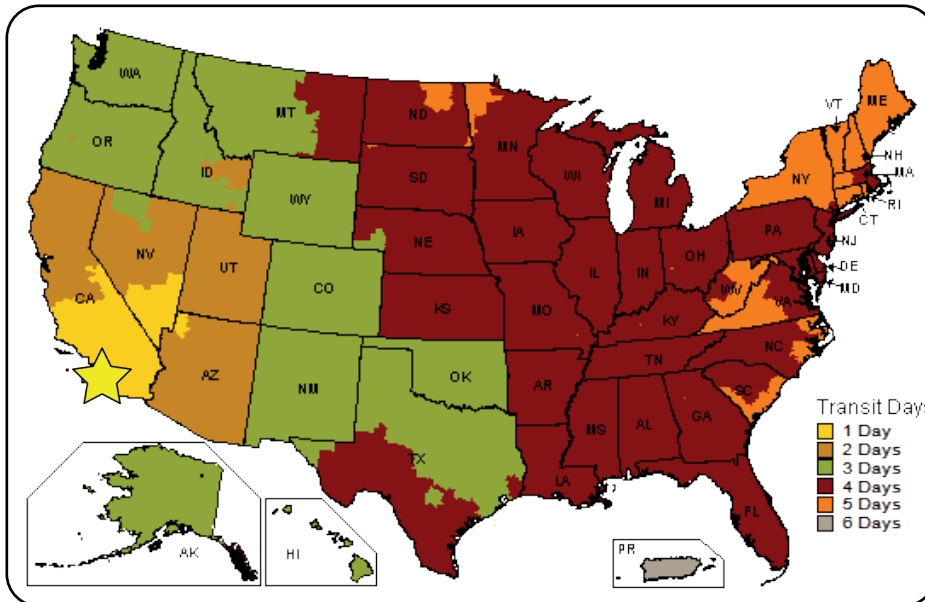

## Approx. Time In Transit Ground Service From Huntington Bch, CA, 02021



### Please Note:

All ground service transit times are approximate business days, are not guaranteed and are meant for guidance only.

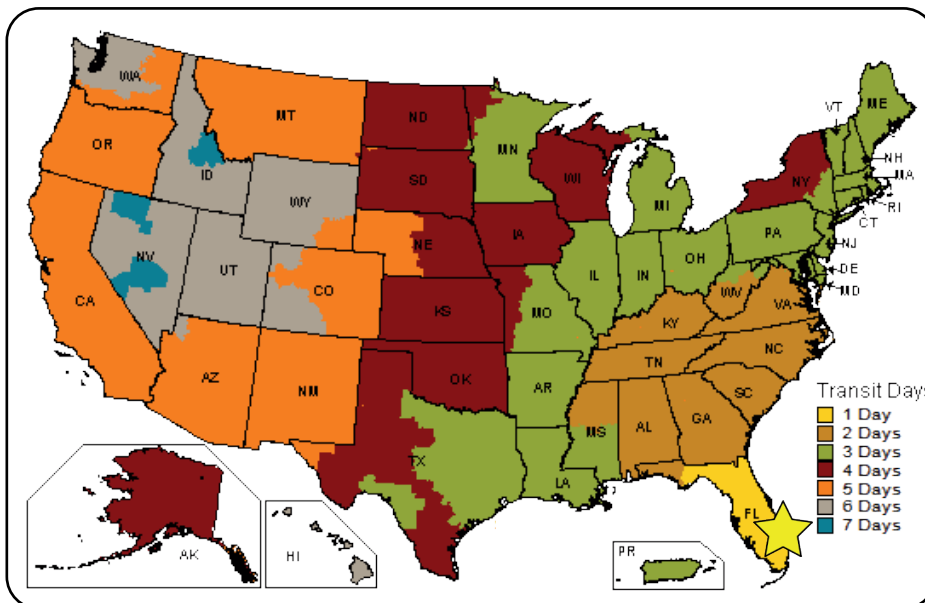

## Approx. Time In Transit Ground Service From Pompano Bch, FL, 33069



### Please Note:

All ground service transit times are approximate business days, are not guaranteed and are meant for guidance only.

Time In Transit Maps courtesy of UPS and correct at time of going to press.

## PLEASE ENQUIRE FOR EXPORT DETAILS

ALL PRODUCTS ARE OFFERED FOR SALE UNDER OUR STANDARD TERMS AND CONDITIONS, which are printed on the reverse of our invoices and below.

The Bainbridge International product range is subject to continuous development. We reserve the right to change product specifications, and improvements will not imply lack of suitability of former production.

### NOT FOR AVIATION USE

Bainbridge International products are NOT designed for use in the manufacture or repair of ultralight aircraft, hang gliders, balloons, parachutes or other aviation products. They must NEVER be used in these applications.

### WARNING

There is potential for sailcloth to contain trace amounts of formaldehyde, a substance known to the State of California to cause cancer. It is not possible to generally predict levels, if any, of formaldehyde exposure which may result from processing of these products. It is recommended that these sailcloth products be stored and processed in a well ventilated area to minimize exposure.

### PRICES

All prices quoted are net in U.S. Dollars, F.O.B. our warehouse in Canton, Massachusetts, U.S.A. Prices published in this catalog are in effect as of the date of publication, subject to change without notice. Orders are accepted on the basis that we will invoice at the prices in effect at time of shipment. However, we will attempt to notify you if the invoice price will differ from the catalog price.

### PAYMENT

Terms of payment are net 30 days from date of invoice (despatch), for credit approved accounts. New accounts and non-approved accounts will be billed net Cash With Order or net Cash on Delivery. Applications for credit from new accounts will be accepted after a minimum of \$500 in purchases have been made. Credit references will be verified as quickly as possible by mail before credit approval is made.

Payment by check should be mailed to:

BAINBRIDGE INTERNATIONAL INC  
255 Revere Street,  
Canton, MA 02021

VISA and MasterCard are also accepted for payment.



### PAST DUE ACCOUNTS

In the event of an account being overdue we reserve the right at our absolute discretion to refuse or limit credit, or to withhold deliveries of goods. A finance charge of 1.5% per month (annual rate 18%) calculated on a day-to-day basis will be applied to past-due accounts from the due date until payment is received at our bank. Any account which is more than 30 days past due will automatically be charged to C.O.D.

### MINIMUM ORDER CHARGE

Minimum invoice value is \$50.

### CUT LENGTHS

Our sales office will be pleased to tell you whether we have any short rolls in inventory for which no cutting charge would apply. Alternatively, fabrics may be cut to length for \$5.00 per cut. Please note that we cannot provide cut lengths under 10 yards.

### PACKING AND DELIVERY

Cost of packaging is included, except where customer specifically requests that we make multiple package shipments where we would not normally expect to do so. Unless otherwise specified, regular delivery will be via United Parcel Service (with freight prepaid by us and added to your invoice) or by other common carrier (freight collect). Responsibility for payment passes to the purchaser when the shipment leaves our warehouse. Once shipment is made any claim for damage or loss should be made to the common carrier.

For speedy delivery of your urgent orders be sure to specify:



Special Shipping

### Hazardous Materials

The triangular symbol next to many chemicals, adhesives, cleaners and protectants indicates that the products must have special packaging and follow specific shipping regulations set forth by the Department of Transport or the International Marine Dangerous Cargo Goods Codes. All hazardous materials must be packaged separately from any other products and labelled ORMD which identifies a consumer commodity. We ship all hazardous goods/materials by UPS Ground, surface parcel post or Sea Freight. Absolutely no Air Freight or express services!! Please consult your Bainbridge International sales representative for additional information.

### RETURNS

Please contact us for authorization before returning any item for credit or replacement. Any goods returned must be delivered to our warehouse within 60 days of the original invoice date. Goods will not be accepted for credit unless accompanied by details of the invoice number against which the goods were supplied by us.

### SALES TAX EXEMPTION

Bainbridge International, Inc., offers its products for sale only to bona fide businesses (corporations, partnerships, or proprietorships). In order to open a new account, we must have a sales tax exemption certificate from customers located in states or provinces which levy sales or use taxes.

1. BUYER ACKNOWLEDGES THAT BAINBRIDGE INTERNATIONAL, INC. FABRICS AND HARDWARE ARE INTENDED FOR USE AS SAILCLOTH AND ARE NOT DESIGNED OR TESTED FOR USE IN ULTRALIGHT, AIRCRAFT, HANG GLIDERS, HOT AIR BALLOONS, PARACHUTES OR ANY OTHER AVIATION PRODUCTS, OR FOR REPAIR OF SUCH PRODUCTS, AND THAT THEY MUST NOT BE USED IN SUCH PRODUCTS UNDER ANY CIRCUMSTANCES. BUYER AGREES TO HOLD BAINBRIDGE INTERNATIONAL, INC. HARMLESS FROM ANY LOSS OR DAMAGE RESULTING FROM BUYER'S USE OF BAINBRIDGE/AQUABATTEN, INC. FABRIC OR HARDWARE IN AVIATION PRODUCTS.

2. This agreement contains all the terms of the contract between BAINBRIDGE INTERNATIONAL, INC. ("Seller") and the buyer ("Buyer"), and, to the extent that any and all prior correspondence, offers, representations and negotiations contain terms which are inconsistent with or different from or additional to those contained herein, the terms of this instrument shall control. The taking of possession by Buyer of all or any part of the goods described on the invoice shall constitute an acceptance by Buyer of the terms hereof.

3. No modification, alteration or amendment of any of the provisions of this instrument shall be valid unless in writing and signed by Seller.

4. All payments are to be made on the due date in U.S. dollars for the full amount shown on the invoice to Seller at its address shown, without allowance for anticipation, and with interest on overdue accounts of 1.5% per month (18% per annum) compounded daily. In case any bills shall not be paid when due, all sums owing under any agreements or dealings between Buyer and Seller shall, at the option of Seller, at once become due irrespective of the terms of sale, and Seller may defer delivery on any contracts between Buyer and Seller until such bills shall be paid and for a reasonable time thereafter. A security interest in the goods described on the invoice shall remain in Seller until all payments shall have been made in full and Buyer will execute any and all documents to enable Seller to perfect this security interest. Seller may in its sole discretion at any time, limit or cancel credit given Buyer, and Seller reserves the right to decline to make deliveries whenever Seller in its discretion determines that the credit standing of Buyer is insufficient and in any such events Seller shall not be liable for the failure to deliver in whole or in part, nor shall Buyer be entitled to cancel. Buyer agrees to reimburse Seller and hold Seller harmless against liability for all expenses, including legal fees, incurred by Seller and arising in connection with Seller's enforcement of its rights under the contract.

5. Unless and except as otherwise expressly provided on the invoice, delivery shall be F.O.B. Seller's place of business. Partial shipments shall be permitted, and if delivery is to be made in installments, no breach by Seller with respect to any installment shall be deemed to be a breach of the entire contract. Delivery to any carrier customarily used by the public for such delivery shall constitute delivery to the Buyer. In the absence of shipping instructions, the mailing of an invoice shall constitute delivery. Goods invoiced and held by Seller for whatever reasons, shall be held at Buyer's risk. Buyer agrees that delay in delivery or defect in quality that violates this contract shall entitle Buyer to cancel only that portion of an order which is delayed in delivery or defective in quality. Any delivery not in dispute shall be paid for separately regardless of dispute as to other delivered or undelivered goods. Upon any breach by Buyer as to any installment, Seller, at its option, may treat such breach as severable or as a breach of the entire contract.

6. Seller shall not be liable for any delay in delivery of any part of the goods due to floods, accidents, strikes, fires, war, government regulation, shortages of materials, or any conditions or causes beyond the reasonable control of Seller. Any increase in Seller's costs due to government legislation, regulation or order providing for a tax on any materials, goods, sales, use or process, or providing for any regulation or control of Seller's purchases, materials, labor, costs, sales, or business, or due to any delay caused by such government legislation, regulations or order, may be added to the price specified. Prices for future invoiced goods are subject to change without notice.

7. Seller shall not be liable for normal manufacturing defects nor any customary variations from quantities or specifications. A variation of not more than 20% either way from the total specified weight shall be deemed compliance with the contract. A variation of not more than 15% either way from the total specified yardage (or other specified units) shall be deemed compliance with the contract. If Buyer claims goods are defective in quality, they must be properly and promptly offered to the Seller for examination and if Buyer fails to make such goods available for examination, Buyer shall not be entitled to any allowance or claim as to such goods. Seller may within a reasonable time after the goods are so offered, replace any goods which are not in accordance with the contract, and in such event no claim may be made by Buyer. Anything herein notwithstanding, in no event shall Seller be liable for claims of any kind or nature unless made in writing either within ten days after delivery of such goods, or after cutting, sizing or converting or otherwise altering the goods in any manner from the original condition of delivery, whichever is earlier. The limit of liability of Seller for late delivery or non-delivery or any other breach shall be the difference, if any, between the contract price and the fair market price, on the date of the invoice, of the goods to be delivered or those actually delivered. In no event shall Buyer be entitled to claim or receive any other damages of any nature whatsoever or any consequential damages and in no instance shall damages include profit or contemplated use or profit of any description.

8. NO WARRANTY IS GIVEN, EXPRESSED OR IMPLIED, AS TO MERCHANTABILITY OR FITNESS OF THE GOODS FOR A PARTICULAR PURPOSE.

Seller has undertaken no responsibility for learning about the end purpose for which the goods are to be used, and Buyer shall undertake whatever necessary steps are required of him for making the goods suitable for such end use. Any greige goods that may be sold hereunder are also sold subject to any imperfections resulting from the finishing thereof, and Seller shall have no liability in connection with any such imperfections. Buyer warrants that all merchandise is purchased for resale as tangible personal property, or to be incorporated as a component or part of other tangible property to be produced for sale by manufacturing, assembling or processing. Buyer agrees to indemnify and hold harmless Seller against any liability, loss, damage or expenses incurred or sustained by reason of any claim or any user of the goods that the goods, separately or incorporated in any product, were negligently manufactured or were not merchantable or fit for a particular purpose. In no event shall Seller be liable for any damages in respect to the sale or use of any product sold hereunder in any amount greater than the amount of the purchase price received by Seller for that particular product. In addition, Seller shall not be liable for any consequential, incidental or special damages or costs or expenses in the event of any breach of warranty or in the event of any default in any term herein or in the event of any loss, damage, injury or cost resulting from or arising out of or in respect of the goods being sold hereunder.

9. When any goods sold hereunder bear a particular label, trademark, or tradename, affixed at the request of the Buyer, it is the understanding of the parties that the Buyer warrants that he has the right to use said label, trademark, tradename, and that he hereby agrees to indemnify and hold harmless Seller against any loss, damage, or claim by any third person with respect thereto.

10. If any provision of the contract is or becomes, at any time for any reason, unenforceable or invalid, no other provision of the contract shall be affected thereby, and the remaining provisions of the contract shall continue with the same effect as if such unenforceable or invalid provision shall not have been inserted in the contract.

11. It is expressly agreed that the validity, performance and construction of contracts will be governed by the internal laws of the Commonwealth of Massachusetts, U.S.A. Any controversy or claim arising out of or relating to any contract, or any breach thereof, shall be settled by arbitration in the City of Boston, Commonwealth of Massachusetts, U.S.A. in accordance with the rules then obtaining of the American Arbitration Association and judgment upon the award rendered may be entered in any court having jurisdiction thereof.

12. Acceptance of any order is expressly made conditional upon Buyer's assent to the terms and conditions set forth above, including those that may be additional or different from those proposed by Buyer.

### ACKNOWLEDGEMENTS

Bainbridge International would like to thank the following companies for their technical support and acknowledge their trademarks:

Twaron<sup>®</sup> is a registered trademark of Teijin Taron BV.

Dacron<sup>®</sup> is a registered trademark of DUPONT.

Spectra<sup>®</sup> and Pentex<sup>®</sup> are registered trademarks of Honeywell International Inc.

Bainbridge<sup>®</sup> and Aquabatten<sup>®</sup> are registered trademarks of Bainbridge International Ltd.

AIRX<sup>™</sup>, DIAX<sup>™</sup> and Sailman<sup>™</sup> are registered Trademarks of Bainbridge International Ltd.

© Bainbridge International Limited 2002

**Section 0 New Products**  
Pages N1-N16

**Section 1 Marine Fabrics**  
Pages 8 - 33

**Section 2 Upholstery Fabrics**  
Pages 34 - 41

**Section 3 General Purpose Fabrics**  
Pages 42 - 53

**Section 4 Awning Fabrics/Hardware**  
Pages 54 - 66

**Section 5 Fasteners**  
Pages 68 - 75

**Section 6 Marine Fittings**  
Pages 76 - 87

**Section 7 Hardware**  
Pages 88 - 111

**Section 8 Seaming Tapes**  
Pages 112 - 115

**Section 9 Thread, Zipper & Velcro**  
Pages 116 - 131

**Section 10 Tools & Supplies**  
Pages 132 - 151

Bainbridge International Inc.  
USA Corporate Headquarters  
255 Revere Street  
Canton  
MA 02021 USA

Tel: 781.821.2600  
Fax: 781.821.2609  
Free: 800.422.5684

Bainbridge International West  
15242 Transistor Lane  
Huntington Beach  
CA 92649 USA

Tel: 714.373.3322  
Fax: 714.373.3326  
Free: 800.433.0101

Bainbridge International S/East  
2580 N. Powerline Road  
Suite: 603  
Pompano Beach  
FL 33069 USA

Tel: 954.532.7557  
Free: 855.599.7741

[www.bainbridgeintusa.com](http://www.bainbridgeintusa.com)  
[info@bainbridgeintusa.com](mailto:info@bainbridgeintusa.com)